

Spezifikation für Freigabe / specification for release

Kunde / customer :

Artikelnummer / part number : **7448640399**



Bezeichnung : **STROMKOMPENSIERTE DROSSEL WE-FC**
 description : **CURRENT-COMPENSATED CHOKE WE-FC**

DATUM / DATE : 2007-08-16

A Mechanische Abmessungen / dimensions:

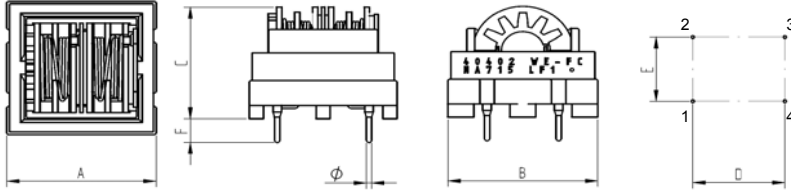

	Gehäuse / case: ET	
A	21,2 max	mm
B	21,2 max	mm
C	17,8 max	mm
D	13,0 ± 0,2	mm
E	10,0 ± 0,2	mm
F	4,5 max	mm
∅	0,8 typ	mm

B Elektrische Eigenschaften / electrical properties:

Eigenschaften / properties	Testbedingungen / test conditions		Wert / value	Einheit / unit	tol.
Leerlauf-Induktivität / inductance	10 kHz / 100 mV / 20°C	L _O	3,90	mH	min
DC-Widerstand / DC-resistance	@ 20 °C	R _{DC}	0,28	Ω	±10%
Nennstrom / rated current	@ 70 °C	I _N	1,00	A	
Nennspannung / rated voltage	50 Hz	U _N	250	V	

C Schaltbild / schematic:

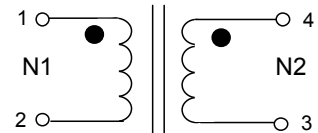

D Prüfgeräte / test equipment:

WAYNE KERR WK3260B/WK3265 für/for L₀ und/and R_{DC}
HP 34401 A für/for I_N

E Testbedingungen / test conditions:

Luftfeuchtigkeit / humidity: 33%
 Umgebungstemperatur / temperature: 20 °C
 Prüfspannung / isolation voltage: 2000 V, 50 Hz

F Werkstoffe & Zulassungen / material & approvals:

Gehäuse / case: UL94V-0
 Draht / wire: P155 IEC317-20
 Kern / core: MnZn-Ferrite / MnZn ferrite

G Eigenschaften / general specifications:

Klimabeständigkeit/ climatic class: 40/125/21
 Betriebstemp. / operating temperature: -25°C - + 125°C
 Übertemperatur / temperature rise: < 55 K
 It is recommended that the temperature of the part does not exceed 125°C under worst case operating conditions.

Freigabe erteilt / general release:	Kunde / customer		
	Unterschrift / signature		
	Würth Elektronik		
	Kontrolliert / approved		
Geprüft / checked	Name	Änderung / modification	Datum / date

This electronic component has been designed and developed for usage in general electronic equipment. Before incorporating this component into any equipment where higher safety and reliability is especially required or if there is the possibility of direct damage or injury to human body, for example in the range of aerospace, aviation, nuclear control, submarine, transportation, (automotive control, train control, ship control), transportation signal, disaster prevention, medical, public information network etc, Würth Elektronik eiSos GmbH must be informed before the design-in stage. In addition, sufficient reliability evaluation checks for s: must be performed on every electronic component which is used in electrical circuits that require high safety and reliability functions or performance.

Würth Elektronik eiSos GmbH & Co. KG

D-74638 Waldenburg · Max-Eyth-Strasse 1 - 3 · Germany · Telefon (+49) (0) 7942 - 945 - 0 · Telefax (+49) (0) 7942 - 945 - 400
<http://www.we-online.com>

Spezifikation für Freigabe / specification for release

Kunde / customer :

Artikelnummer / part number : **7448640399**



Bezeichnung : **STROMKOMPENSIERTE DROSSEL WE-FC**
 description : **CURRENT-COMPENSATED CHOKE WE-FC**

DATUM / DATE : 2007-08-16

H Einfügungsdämpfung / insertion loss:

typischer Dämpfungsverlauf / typical attenuation curve

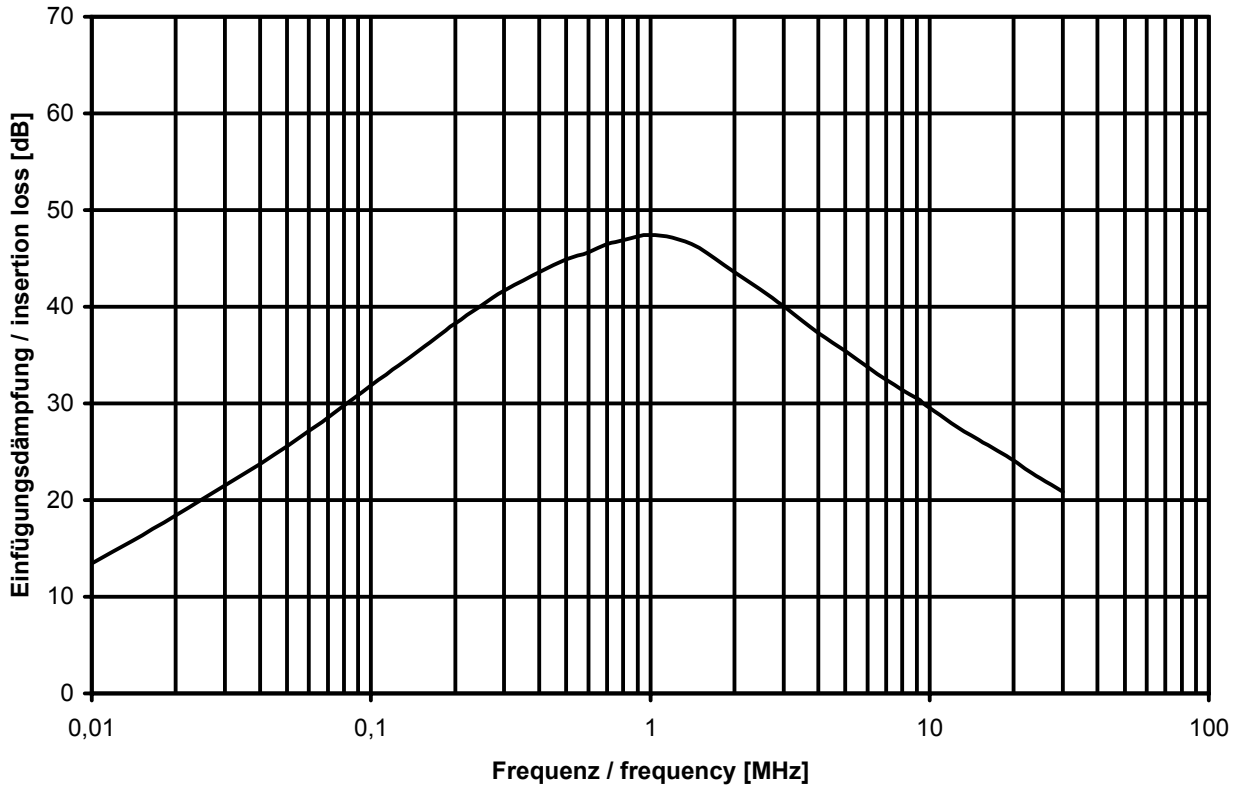

common mode

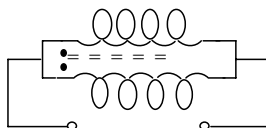

Datum / date			
Geprüft / checked	Kontrolliert / approved	Name	Änderung / modification
Geprüft / checked	Kontrolliert / approved	Name	Änderung / modification
		Datum / date	

This electronic component has been designed and developed for usage in general electronic equipment. Before incorporating this component into any equipment where higher safety and reliability is especially required or if there is the possibility of direct damage or injury to human body, for example in the range of aerospace, aviation, nuclear control, submarine, transportation, (automotive control, train control, ship control), transportation signal, disaster prevention, medical, public information network etc, Würth Elektronik eiSos GmbH must be informed before the design-in stage. In addition, sufficient reliability evaluation checks for safety must be performed on every electronic component which is used in electrical circuits that require high safety and reliability functions or performance.

Würth Elektronik eiSos GmbH & Co. KG

D-74638 Waldenburg · Max-Eyth-Strasse 1 - 3 · Germany · Telefon (+49) (0) 7942 - 945 - 0 · Telefax (+49) (0) 7942 - 945 - 400
<http://www.we-online.com>

Spezifikation für Freigabe / specification for release

Kunde / customer :

Artikelnummer / part number : **7448640399**

Bezeichnung : **STROMKOMPENSIERTE DROSSEL WE-FC**

description : **CURRENT-COMPENSATED CHOKE WE-FC**



DATUM / DATE : 2007-08-16

I Stangenspezifikation / tube specification:

Stangenspezifikation / tube specification:		
L	525	mm
H	31	mm
B	24,5	mm

Menge: 23 Stück/Stange
quantity: 23 pieces/tube

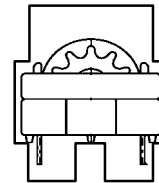
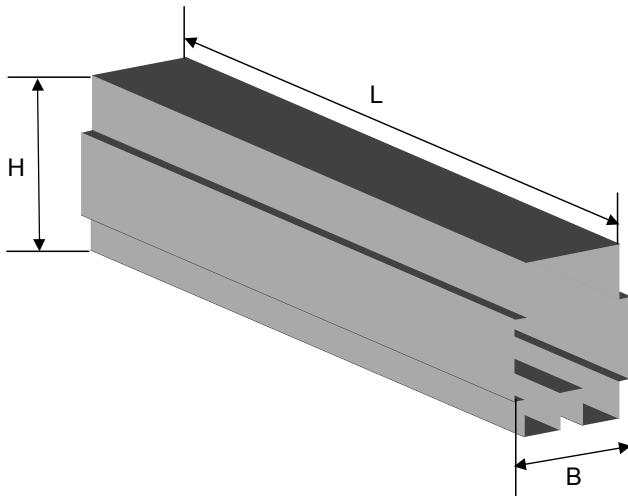

Freigabe erteilt / general release:	Kunde / customer			
Datum / date	Unterschrift / signature			
	Würth Elektronik			
Geprüft / checked	Kontrolliert / approved	Name	Änderung / modification	Datum / date

This electronic component has been designed and developed for usage in general electronic equipment. Before incorporating this component into any equipment where higher safety and reliability is especially required or if there is the possibility of direct damage or injury to human body, for example in the range of aerospace, aviation, nuclear control, submarine, transportation, (automotive control, train control, ship control), transportation signal, disaster prevention, medical, public information network etc, Würth Elektronik eiSos GmbH must be informed before the design-in stage. In addition, sufficient reliability evaluation checks for safety must be performed on every electronic component which is used in electrical circuits that require high safety and reliability functions or performance.

Würth Elektronik eiSos GmbH & Co. KG

D-74638 Waldenburg · Max-Eyth-Strasse 1 - 3 · Germany · Telefon (+49) (0) 7942 - 945 - 0 · Telefax (+49) (0) 7942 - 945 - 400
<http://www.we-online.com>