

R82, Film, Metallized Polyester Stacked, Automotive Grade, 1 uF, 5%, 63 VDC, 85°C, Lead Spacing = 5mm

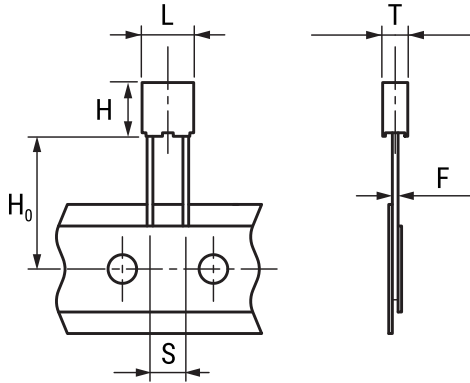

Dimensions

L	7.2mm +0.3mm
H	10mm +0.1mm
T	5mm +0.1mm
S	5mm +0.6/-0.1mm
H0	18.5mm +/-0.5mm
F	0.5mm +/-0.05mm

Packaging Specifications

Packaging:	Ammo, 360x340x59mm, Box
Packaging Quantity:	1700

General Information

Supplier:	KEMET
Series:	R82
Dielectric:	Metallized Polyester Stacked
Style:	Radial
Features:	Automotive Grade, DC Multipurpose Applications
RoHS:	Yes
Lead:	Wire Leads
Qualifications:	AEC-Q200
AEC-Q200:	Yes
Miscellaneous:	Above 85C DC And AC Voltage Derating Is 1.25%/C

Specifications

Capacitance:	1 uF
Capacitance Tolerance:	5%
Voltage AC:	40 VAC
Voltage DC:	63 VDC
Temperature Range:	-55/+105C
Rated Temperature:	85°C
Dissipation Factor:	0.80% 1kHz, 1.20% 10kHz
Insulation Resistance:	5 GOhms
Max dV/dt:	160 V/us
Inductance:	7 nH