

Product Information



IEP160x50-Ø20

EAN 4031582319705

Wheel centre made of Aluminium, Tread: black elastic-tyre, vulcanized, precision ball bearing

Technical Data

Wheel diameter	160 mm
Width of Tread	50 mm
Axle Hole-Ø	20 mm
Hub length	60 mm
Temperature	- 20 / + 85 °C
Standard	EN 12532
Weight	1.204 kg
Hardness of tread	A 67 Shore
Load capacity	350 kg
Load capacity (static)	700 kg



Roll performance	+	+	+	+	+
Movement noise	+	+	+	+	+
Attrition	+	+	+	+	+
Corrosion resistance	+	+	+	+	+

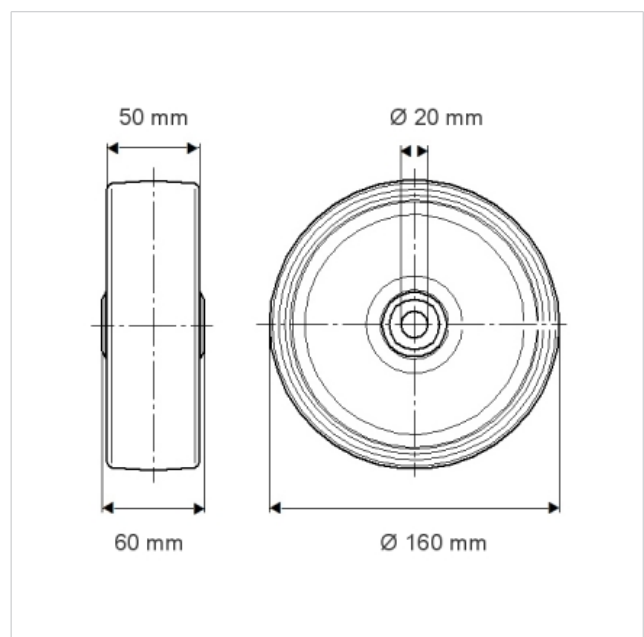



IEP160x50-Ø20

EAN 4031582319705

