

Datasheet

N type-UFL RF cable assembly

RS Stock number 794-2850



Dimensions: (mm)

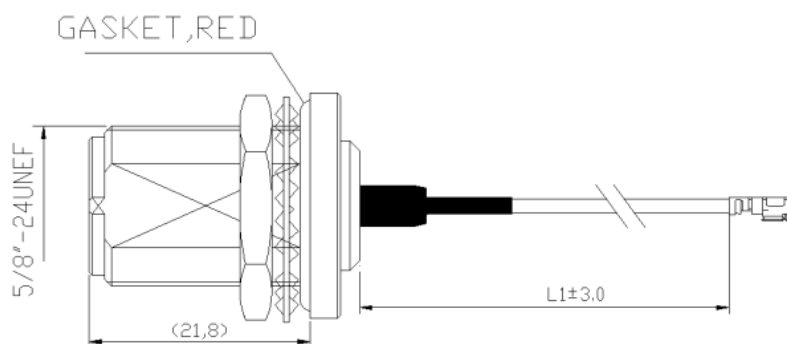

Specification

PRODUCT MATERIAL

1. N B/H JACK CRIMP TYPE FOR $\varnothing 1.37\text{mm}$ CABLE NUT x 1, WASHER x 1
2. U.FL-LP-088 Halogen Free For $\varnothing 1.37\text{mm}$ Cable
3. U.FL-088 CONTACT For $\varnothing 1.37\text{mm}$ Cable
4. 1.37mm CABLE TIN PLATED COLOR:BLACK
5. HEAT SHRINK TUBE F32 $\varnothing 2.5\text{mm}$ L=15.0mm COLOR:BLACK.

ELECTRICAL PERFORMANCE:

- 1.IMPEDANCE:50 OHMS
- 2.FREQUENCY RANGE:DC~3GHz
- 3.WORKING VOLTAGE:250Vrms MAXIMUM
- 4.DIELECTRIC WITHSTANDING VOLTAGE:750Vrms min.