

# Datasheet

## Header with 90° (angled) Pins for Horizontal Mounting

RS Stock number 458-358

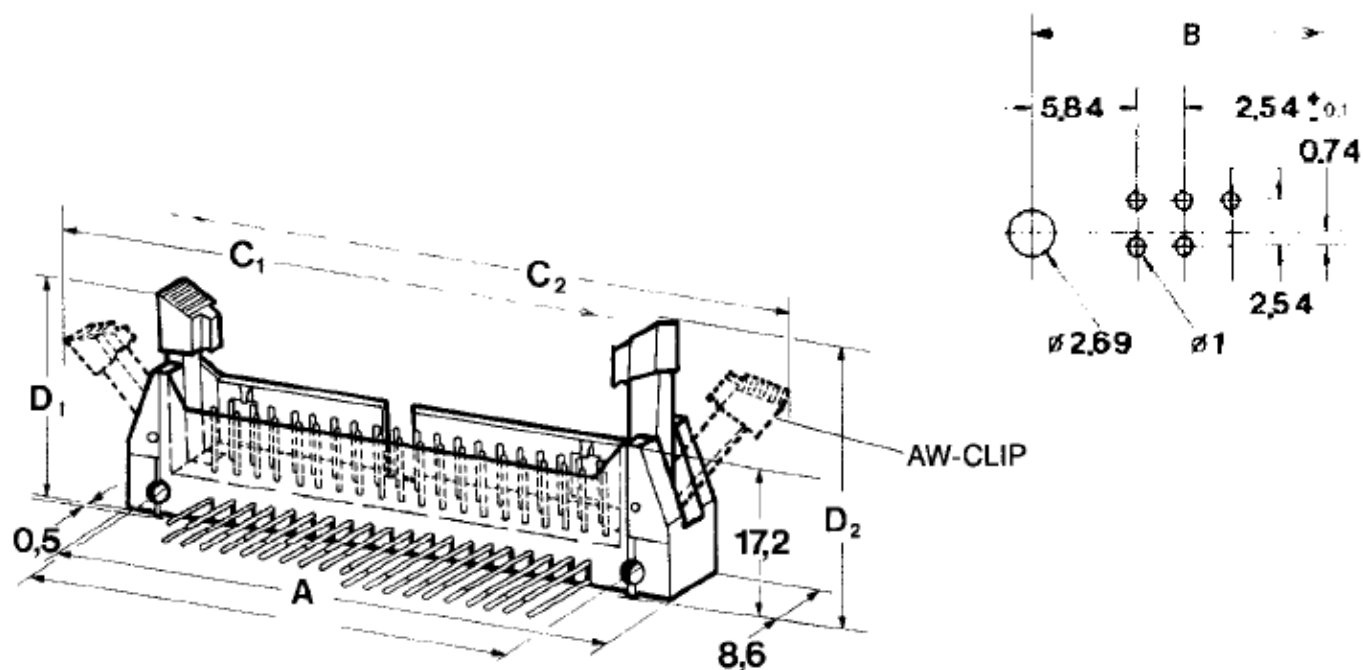

Stock no.	No. of Ways	A	B	C <sub>1</sub>	C <sub>2</sub>	D <sub>1</sub>	D <sub>2</sub>
458-320	14	37.3	26.92	49.5	55.0	23.1	26.5
458-336	16	39.9	29.46	52.1	57.6	23.1	26.5
458-342	20	44.8	34.54	57.0	62.5	23.1	26.5
458-358	26	52.4	42.16	64.6	70.1	23.1	26.5
458-370	40	70.2	59.94	82.4	87.9	23.1	26.5
458-386	50	83.0	72.64	95.2	100.7	23.1	26.5



ENGLISH

### **Specifications:**

Insulators:	Polyester GV, VO, UL 94, colour grey, RAL 7035
Operating Temperature Range:	-65 to +150
Current Carrying Capacity:	1A
Tensile Strength:	1000Veff
Contacts:	Phosphor Bronze