

Ordering number C12331
Description 1

Family	Strada-T	FWHM	Asym degrees
Type	Lens	Efficiency	93 %
LED	NS6x83	cd/Im	-
Color	Clear	Gerber File	Available
Diameter	19.6 x 15.5 mm		
Height	10.9 mm		
Style	Rectang		
Optic Material	PMMA		
Holder Material	-		
Fastening	-		
Status	Ready		

Ordering number CA12333
Description 1

Family	Strada-T	FWHM	Asym degrees
Type	Assembly	Efficiency	92 %
LED	NS6x83	cd/Im	-
Color	Clear	Gerber File	Available
Diameter	19.6 x 15.5 mm		
Height	11.3 mm		
Style	Rectang		
Optic Material	PMMA		
Holder Material	-		
Fastening	-		
Status	Ready		



PRODUCT DATASHEET
Strada-T series
last update 11/12/2012



NOTE: The typical divergence will be changed by different color, chip size and chip position tolerance. The typical total divergence is the full angle measured where the luminous intensity is half of the peak value.

D

C

B

A

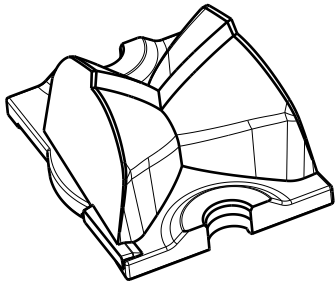

Isometric view

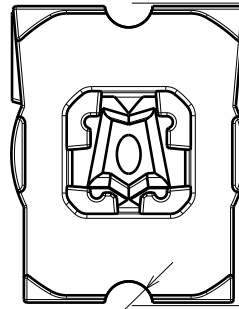

20

fastening

Bottom view

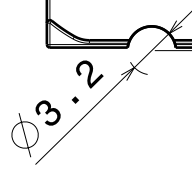

3.2

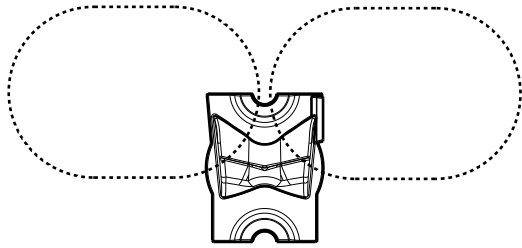

Beam direction

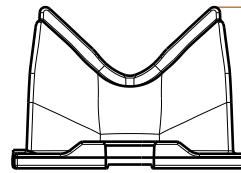

10.9
with tape 11.3

Front view

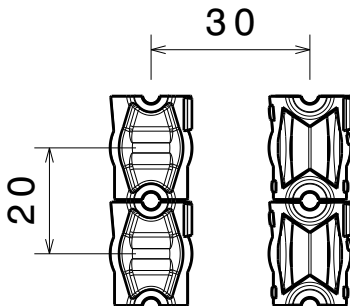

Strada lens arrangement recommendation

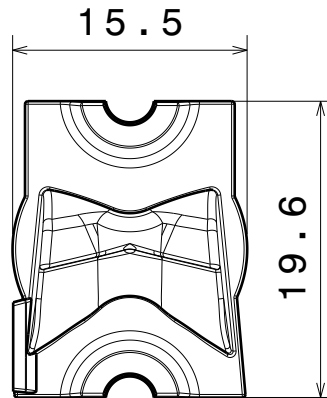

Top view

MATERIALS
 Lens: PMMA
 Tape(optional): PU Foam

Part no. with tape fastening: CA12333_Strada-T-DW

This drawing is our property.
 It can't be reproduced
 or communicated without
 our written agreement.



Ledil Oy
 Tehdaskatu 13
 FIN-24100 SALO
 Finland

DRAWING TITLE

Datasheet STRADA-T-DW

DRAWN BY

ah

DATE

13.12.2011

CHECKED BY

vs

DATE

13.12.2011

SIZE

A4

DRAWING NUMBER

C12331

REV

1

DESIGNED BY

hh

DATE

17.05.2010

SCALE

2:1

WEIGHT (g)

SHEET

1/1

D

A

4

4

3

3

2

2

1

1