



M-DUINO FAMILY



M-Duino 58 User Guide:

1. Index

- 2. General Description M-DUINO FAMILY products 3
- 2.1. Mechanical dimensions..... 4
- 3. Precautions..... 4
- 3.1. Arduino Board 4
- 3.2. Intended Audience 4
- 3.3. General Precautions 4
- 4. Specifications 5
- 4.1. General Specifications:..... 5
- 4.2. Performance Specification: 6
- 5. Before to connect:..... 7
- 5.1. Software interface..... 7
- 5.2. How to connect PLC arduino to PC 7
- 5.3. How to connect PLC to power supply 8
- 6. M-duino 58 I/O Pinout: 10
- 6.1. A Zone connection 10
- 6.2. A Zone top 11
- 6.3. B Zone..... 11
- 6.4. B Zone top 12
- 6.5. C Zone..... 12
- 6.6. C Zone top 13
- 6.7. D Zone 13
- 6.8. D Zone top..... 14
- 7. I/O Pinout (summary pinout/ Arduino PIN): 15



8.	Switch configuration	16
8.1	A Zone	16
8.2	B, C and D Zones.....	16
9.	I/O technical details:	16
10.	Connector details	17
11.	Connection type	19
11.1	Digital Inputs	19
11.2	Analog (0-10Vdc) / Digital Inputs “configurable”	20
	Analog configuration mode:.....	20
	Digital configuration mode:	21
11.3	Digital Outputs	22
11.4	Analog (0-10Vdc) / PWM / Digital Outputs “configurable”	23
	Analog configuration mode:.....	23
	Digital configuration mode:	24
	PWM configuration mode:.....	25
11.5	Relay Outputs.....	26
12.	Communication Pinout.....	27
13.	Mechanical Characteristics	28
14.	Software Interface:.....	29



COMPACT PLC.



INDUSTRIAL SHIELDS

2. General Description M-DUINO FAMILY products



A compact PLC based in Open Source Hardware technology. With different Input/Outputs Units.

Supply Voltage

24 Vcc

Compact

DIN rail mounting



Safety

Industrial communications

I/Os

Digital
Analog
Relay

CONNECTABLE PLC ARDUINO 24Vcc M-DUINO

MODEL TYPE	21 I/Os	42 I/Os	58 I/Os
Input Voltage	12- 24Vdc		
I max.	0,5A		
Size	101x119.5x70.1	101x119.5x94.7	101x119.5x119.3
Clock Speed	16MHz		
Flash Memory	32KB of wich 0,5KB used by bootlader		
SRAM	2KB		
EEPROM	1KB		
Communications	I2C ¹ – Ethernet Port – USB – RS485 -- SPI – (3x) Rx,Tx (Arduino pins)		
TOTAL Input points	13	26	36
TOTAL Output points	8	16	22
Type of signals			
* An/Dig Input 10bit (0-10Vcc)	6	12	16
* Digital Input (24Vcc)	13	26	36
* Interrupt Input HS (24Vcc)	2	4	6
* Analog Output (0-10Vcc)	3	6	8
* Digital Output (24Vcc)	8	16	22
* PWM Output 8bit (24Vcc)	3	6	8
Expandability	I2C ¹ - 127 elements - communication boards - Ethernet		
Reference	IS.MDUINO.base.21	IS.MDUINO.base.42	IS.MDUINO.base.58
<p>* By using this type of signal can no longer use Digital signal (24Vdc) You must to read product Datasheet. (1) IMPORTANT. Visit accessories/communication section.</p>			

¹ 10k pull-up resistance required (IS.AC12C-4.7K)



2.1. Mechanical dimensions

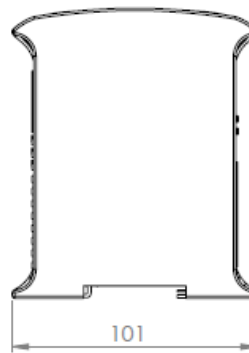
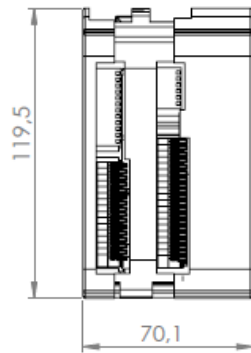

M-Duino 21 I/Os

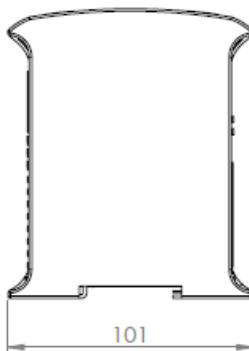
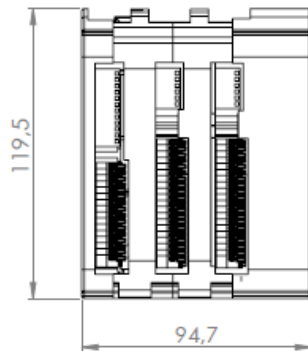

M-Duino 42 I/Os

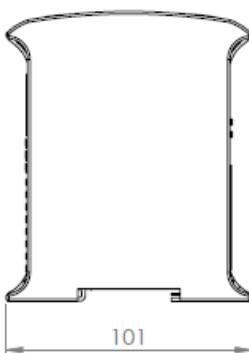
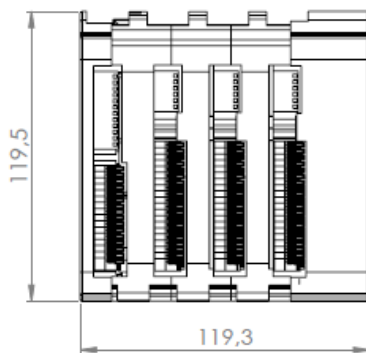

M-Duino 58 I/Os

3. Precautions

3.1. Arduino Board

All M-duino family products use Arduino MEGA Board.

3.2. Intended Audience

This manual is intended for the following personal, which must also have knowledge of electrical systems.

3.3. General Precautions

The user must operate the product according to the performance specifications described in the operation manuals.

Before using the product under conditions, which are not described in the manual or applying the product to nuclear control systems, railroad systems, aviation systems, vehicles,



combustion systems, medical equipment, amusement machines, safety equipment and other systems, machines, and equipment that may have a serious influence on lives and property if used improperly, consult your INDUSTRIAL SHIELDS representative.

Make sure that the rating and performance characteristics of the product are sufficient for the systems, machines, and equipment, and be sure to provide the systems, machines, and equipment with double safety mechanisms.

This manual provides information for programming and operating the Unit. Be sure to read this manual before attempting to use the Unit keep this manual close at hand for reference during operation.



Warnings:

- Unused pins should not be connected. Ignoring the directive may damage the controller.
- Improper use of this product may severely damage the controller.
- Refer to the controller’s User Guide regarding wiring considerations.
- Before using this product, it is the responsibility of the user to read the product’s User Guide and all accompanying documentation.

4. Specifications

4.1. General Specifications:

Item		M-DUINO 21 IOs	M-DUINO 42 IOs	M-DUINO 58 IOs
Power supply voltage	DC power supply	12 - 24Vdc		
Operating voltage range	DC power supply	11.4 to 25.4Vdc		
Power consumption	DC power supply	30VAC max.		
External power supply	Power supply voltage	24Vdc		
	Power supply output capacity	700Ma		
Insulation resistance		20MΩ min.at 500Vdc between the AC terminals and the protective earth terminal.		
Dielectric strength		2.300 VAC at 50/60 HZ for one minute with a leakage current of 10mA max. Between all the external AC terminals and the protective earth terminal.		
Shock resistance		80m/s ² in the X, Y and Z direction 2 times each.		
Ambient temperature (operating)		0° to 45°C		
Ambient humidity (operating)		10% to 90% (no condensation)		



Ambient environment (operating)	With no corrosive gas		
Ambient temperature (storage)	-20° to 60°C		
Power supply holding time	2ms min.		
Weight	445g max.	542g max.	850g max.

4.2. Performance Specification:

Item	M-DUINO 21 IOs	M-DUINO 42 IOs	M-DUINO 58 IOs
Arduino Board	ARDUINO MEGA 2560		
Control method	Stored program method		
I/O control method	Combination of the cyclic scan and immediate refresh processing methods.		
Programming language	Arduino IDE. Based on wiring (Wiring is an Open Source electronics platform composed of a programming language. "similar to the C". http://arduino.cc/en/Tutorial/HomePage)		
Microcontroller	ATmega2560		
Flash Memory	256kb of wich 8 kb used by bootloader		
Program capacity (SRAM)	8kb		
EEPROM	4kb		
Clock Speed	16MHz		
Clock Speed	16MHz		



5. Before to connect:

5.1. Software interface

Arduino IDE is compatible for programming these PLCs. You must to download a start code in www.industrialshields.com at product page in “document files” section and then It is necessary open it with Arduino IDE.

Configuration about Arduino IDE:

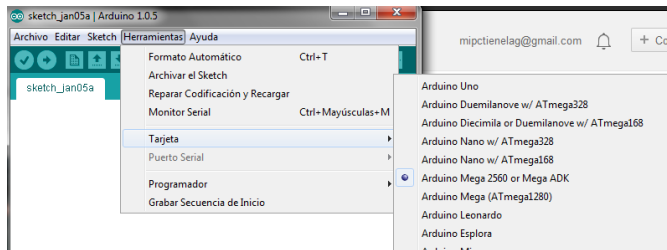

5.2. How to connect PLC arduino to PC

- Connect USB port from PLC to PC.

NOTE:

M-Duino Family use USB-B cable.



- Open Arduino IDE interface:
You can install with this link:
<http://arduino.cc/download.php?f=/arduino-1.0.6-windows.exe>

- Select Arduino Board

NOTE:

M-Duino Family use Arduino MEGA 2560.

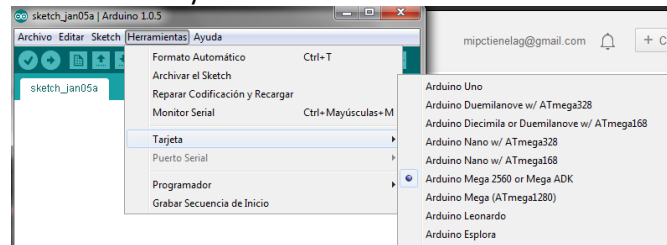

- **IMPORTANT:** For M-duino Family you need set the *AUTORESET* switch to on when uploading the program to Arduino Mega 2560 (see section 6.2).



- Select correct port.

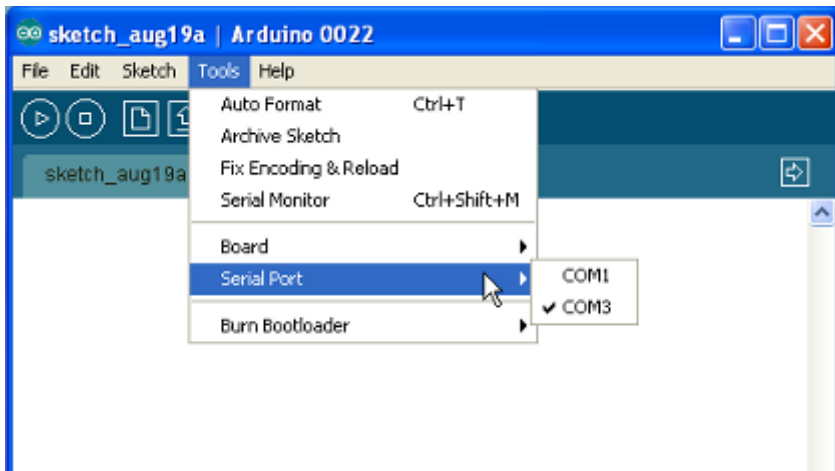

IMPORTANT:

Verify the USB port is detected:

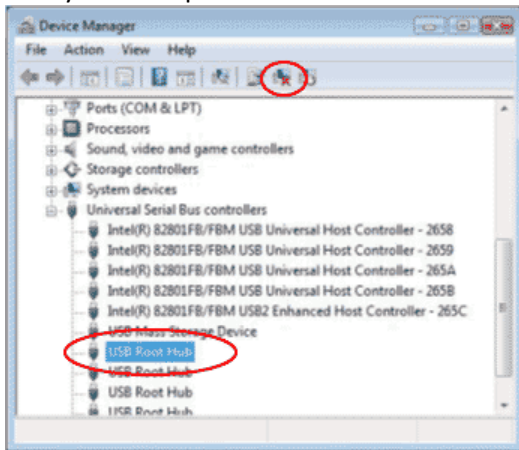

5.3. How to connect PLC to power supply

- Mduino Family PLC are 24Vdc supplied. IMPORTANT: The polarity IS NOT REVERSAL!
- Make sure that the live and GND connector of the power supply match the PLC.
- Make sure that the power supply mains output is not higher than 24Vdc.

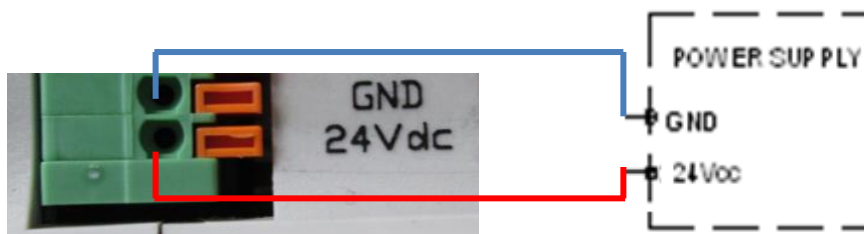



- Suggested power suppliers



* Not recommended for industrial applications. The *Jack* connector needs to be removed and use the live and GND connectors.





6. M-duino 58 I/O Pinout:

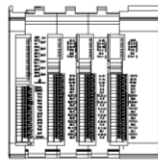
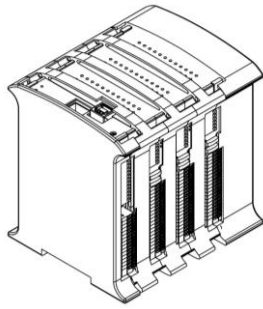

A ZONE
B ZONE
C ZONE
D ZONE

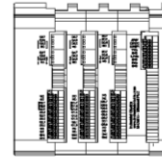

D ZONE
C ZONE
B ZONE
A ZONE

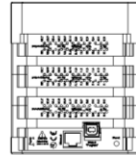

D ZONE
C ZONE
B ZONE
A ZONE

6.1. A Zone connection

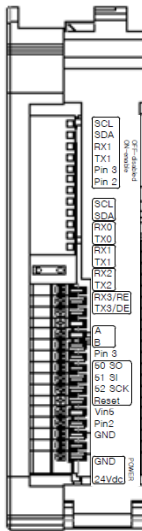

Configuration Switch* (see section 12 for Communications configuration. Enabling Communications disable s some I/Os)

Communication Pinout

Power supply connectors (24Vdc – Gnd)

Base (common unit)		
A Zone		
M-Duino Connector	Arduino Pin	Function
SCL	21	SCL
SDA	20	SDA
RX0	1	RX0
TX0	0	TX0
RX1	19	RX1
TX1	18	TX1
RX2	17	RX2
TX2	16	TX2
RX3/RE	15	RX3/RS485
TX3/DE	14	TX3/RS485
A	-	RS485
B	-	RS485
PIN3	3	Arduino Pin/ Select SPI
50 SO	50	SPI
51 SI	51	SPI
52 SCK	52	SPI
Reset	Reset	SPI
Vin5	Vin5	SPI
PIN2	2	Arduino Pin/ Select SPI
GND	-	Gnd
GND	-	Gnd
24Vdc	-	

Base (common unit)		
A Zone		
M-Duino Connector	Arduino Pin	Function
AREF	AREF	Arduino PIN
IOREF2	IOREF2	Arduino PIN
IOREF1	IOREF1	Arduino PIN
7Vdc	7Vdc	-
Gnd	Gnd	GND
3.3Vdc	3.3Vdc	Arduino PIN
GND	Gnd	GND
5Vdc	5Vdc	-
GND	Gnd	GND

Pin out function

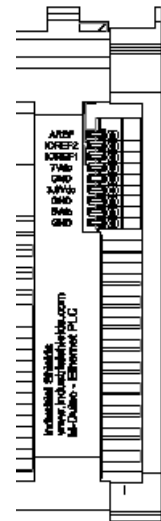



6.2. A Zone top

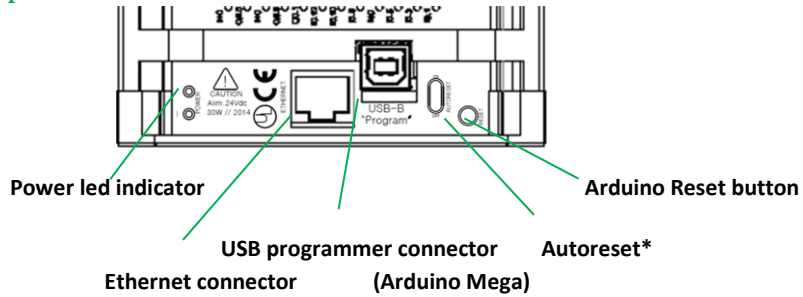

*NOTE: Autoreset. Arduino mega has auto reset when using serial communication code. Set switch to OFF when using serial communication. When uploading code to Arduino Mega set switch to ON.

6.3. B Zone

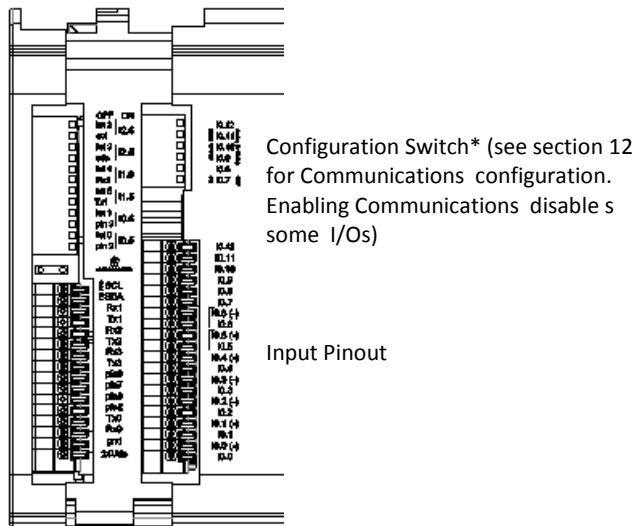

B Zone		
M-Duino Connector	Arduino Pin	Function ²
10.12	A5	Analog/ Digital In
10.11	A4	Analog/ Digital In
10.10	A3	Analog/ Digital In
10.9	A2	Analog/ Digital In
10.8	A1	Analog/ Digital In
10.7	A0	Analog/ Digital In
COM-10.6	NC	GND 10.6
10.6 ³	3	Interrupt 1 In
COM-10.5	NC	GND 10.5
10.53	2	Interrupt 0 In
COM-10.4	NC	GND 10.4
10.4	26	Digital Input
COM-10.3	NC	GND 10.3
10.3	25	Digital Input
COM-10.2	NC	GND 10.2
10.2	24	Digital Input
COM-10.1	NC	GND 10.1
10.1	23	Digital Input
COM-10.0	NC	GND 10.0
10.0	22	Digital Input

B Zone		
M-Duino Connector	Arduino Pin	Function ²
NC	NC	COM- Q (+)
NC	NC	COM- Q (-)
Q0.7	6	Analog/PWM/digital Out
Q0.6	5	Analog/PWM/digital Out
Q0.5	4	Analog/PWM/digital Out
Q0.4	40	Digital Out
Q0.3	39	Digital Out
Q0.2	38	Digital Out
Q0.1	37	Digital Out
Q0.0	36	Digital Out
NC	NC	NC
NC	NC	NC
Gnd	Gnd	Gnd
Gnd	Gnd	Gnd

Configuration Switch* (see section 8 to select correct configuration for outputs).

Output Pinout

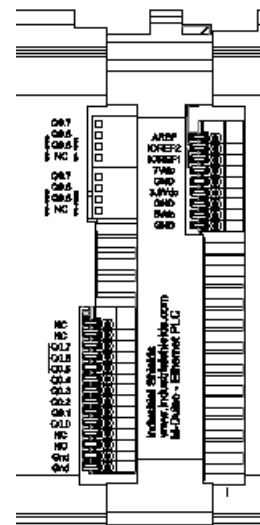

² See section 8 to select suitable switch configuration for (10-24Vdc/An-Dig) configurable I/Os.

³ See section 8 to enable these connections.



6.4. B Zone top

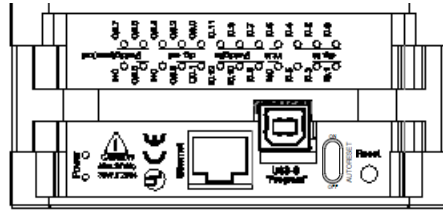

Led indicator I/Os state

6.5. C Zone

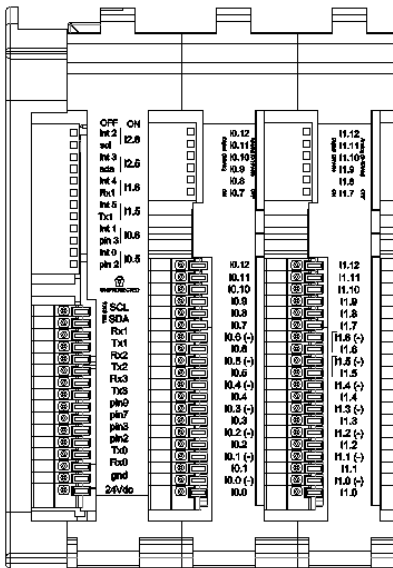

Configuration Switch*
(see section 8 to select correct configuration for inputs).

Input Pinout

C Zone		
M-Duino Connector	Arduino Pin	Function ⁴
I1.12	A11	Analog/ Digital In
I1.11	A10	Analog/ Digital In
I1.10	A9	Analog/ Digital In
I1.9	A8	Analog/ Digital In
I1.8	A7	Analog/ Digital In
I1.7	A6	Analog/ Digital In
COM-I1.6	NC	GND I1.6
I1.6 ⁵	19	Interrupt 4 In
COM-I1.5	NC	GND I1.5
I1.5 ⁵	18	Interrupt 5 In
COM-I1.4	NC	GND 1.4
I1.4	31	Digital Input
COM-I1.3	NC	GND I1.3
I1.3	30	Digital Input
COM-I1.2	NC	GND I1.2
I1.2	29	Digital Input
COM-I1.1	NC	GND I1.1
I1.1	28	Digital Input
COM-I1.0	NC	GND I1.0
I1.0	27	Digital Input

C Zone		
M-Duino Connector	Arduino Pin	Function ⁴
NC	NC	COM- Q (+)
NC	NC	COM- Q (-)
Q1.7	9	Analog/PWM/digital Out
Q1.6	7	Analog/PWM/digital Out
Q1.5	8	Analog/PWM/digital Out
Q1.4	45	Digital Out
Q1.3	44	Digital Out
Q1.2	43	Digital Out
Q1.1	42	Digital Out
Q1.0	41	Digital Out
NC	NC	NC
NC	NC	NC
Gnd	Gnd	Gnd
Gnd	Gnd	Gnd

Configuration Switch*
(see section 8 to select correct configuration for outputs).

Output Pinout

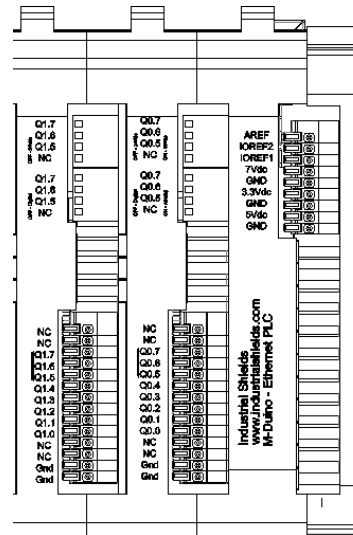

⁴ See section 8 to select suitable switch configuration for (10-24Vdc/An-Dig) configurable I/Os.

⁵ See section 8 to enable these connections.



6.6. C Zone top

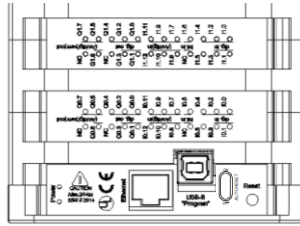

Led indicator I/Os state

6.7. D Zone

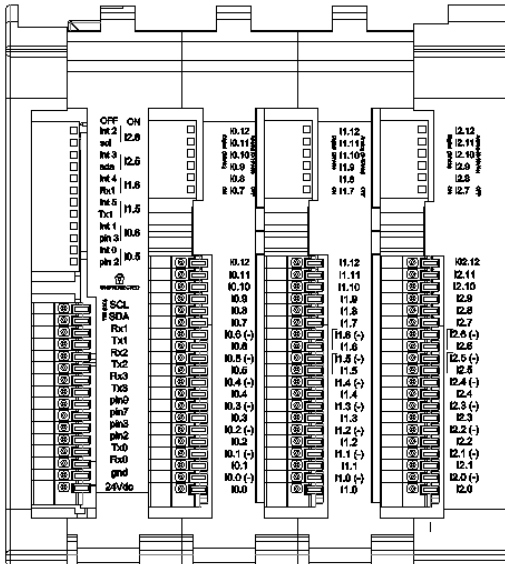

Configuration Switch*
(see section 8 to select correct configuration for inputs).

Input Pinout

D Zone		
M-Duino Connector	Arduino Pin	Function ⁶
I2.12	NC	NC
I2.11	NC	NC
I2.10	A15	Analog/ Digital In
I2.9	A14	Analog/ Digital In
I2.8	A13	Analog/ Digital In
I2.7	A12	Analog/ Digital In
COM-I2.6	NC	GND I2.6
I2.6 ⁷	21	Interrupt 2 In
COM-I2.5	NC	GND I2.5
I2.5 ⁷	20	Interrupt 3 In
COM-I2.4	NC	NC
I2.4	NC	NC
COM-I2.3	NC	GND I2.3
I2.3	35	Digital Input
COM-I2.2	NC	GND I2.2
I2.2	34	Digital Input
COM-I2.1	NC	GND I2.1
I2.1	33	Digital Input
COM-I2.0	NC	GND I2.0
I2.0	32	Digital Input

D Zone		
M-Duino Connector	Arduino Pin	Function ⁶
NC	NC	COM- Q (+)
NC	NC	COM- Q (-)
Q2.7	NC	NC
Q2.6	13	Analog/PWM/digital Out
Q2.5	12	Analog/PWM/digital Out
Q2.4	NC	NC
Q2.3	49	Digital Out
Q2.2	48	Digital Out
Q2.1	47	Digital Out
Q2.0	46	Digital Out
NC	NC	NC
NC	NC	NC
Gnd	Gnd	Gnd
Gnd	Gnd	Gnd

Configuration Switch*
(see section 10 to select correct configuration for outputs).

Output Pinout

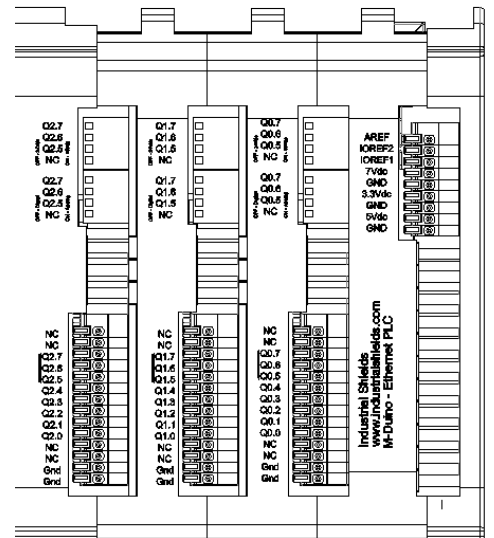

⁶ See section 8 to select suitable switch configuration for (10-24Vdc/An-Dig) configurable I/Os.

⁷ See section 8 to enable these connections.



INDUSTRIAL SHIELDS

6.8. D Zone top

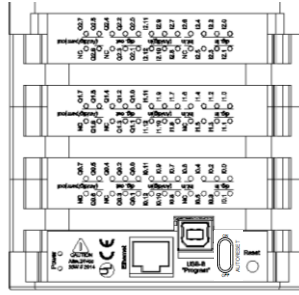

Led indicator I/Os state



7. I/O Pinout (summary pinout/ Arduino PIN):

Base (common unit)			M-DUINO 58 IOs								
			M-DUINO 42 IOs								
			M-DUINO 21 IOs			C Zone			D Zone		
A Zone			B Zone			C Zone			D Zone		
M-Duino Connector	Arduino Pin	Function	M-Duino Connector	Arduino Pin	Function	M-Duino Connector	Arduino Pin	Function	M-Duino Connector	Arduino Pin	Function
SCL	21	SCL	I0.12	A5	Analog/ Digital In	I1.12	A11	Analog/ Digital In	<i>I2.12</i>	NC	NC
SDA	20	SDA							<i>I2.11</i>	NC	NC
RX0	1	RX0	I0.11	A4	Analog/ Digital In	I1.11	A10	Analog/ Digital In	I2.10	A15	Analog/ Digital In
TX0	0	TX0									
RX1	19	RX1	I0.10	A3	Analog/ Digital In	I1.10	A9	Analog/ Digital In	I2.9	A14	Analog/ Digital In
TX1	18	TX1									
RX2	17	RX2	I0.9	A2	Analog/ Digital In	I1.9	A8	Analog/ Digital In	I2.8	A13	Analog/ Digital In
TX2	16	TX2									
RX3/RE	15	RS485	I0.8	A1	Analog/ Digital In	I1.8	A7	Analog/ Digital In	I2.7	A12	Analog/ Digital In
TX3/DE	14	RS485									
A	-	RS485	I0.7	A0	Analog/ Digital In	I1.7	A6	Analog/ Digital In	COM-I2.6	NC	GND I2.6
B	-	RS485							I2.6	21	Digital In/ Interrupt 2*
PIN3	3	Arduino Pin	COM-I0.6	NC	GND I0.6	COM-I1.6	NC	GND I1.6			Digital In/ Interrupt 2*
SO	50	SPI	I0.6	3	Digital In/ Interrupt 1*	I1.6	19	Digital In/ Interrupt 4*	COM-I2.5	NC	GND I2.5
SI	51	SPI							I2.5	20	Digital In/ Interrupt 3*
SCK	52	SPI	COM-I0.5	NC	GND I0.5	COM-I1.5	NC	GND I1.5			Digital In/ Interrupt 3*
Reset	Reset	SP	I0.5	2	Digital In/ Interrupt 0*	I1.5	18	Interrupt 5 In	<i>COM-I2.4</i>	NC	NC
Vin5	Vin5	SPI				COM-I1.4	NC	GND 1.4	<i>I2.4</i>	NC	NC
PIN2	2	Arduino Pin	COM-I0.4	NC	GND I0.4	I1.4	31	Digital Input	COM-I2.3	NC	GND I2.3
Gnd	-	Gnd	I0.4	26	Digital Input	COM-I1.3	NC	GND 1.3	I2.3	35	Digital Input
Gnd	-	Gnd	COM-I0.3	NC	GND I0.3	I1.3	30	Digital Input	COM-I2.2	NC	GND I2.2
24Vdc	-	-	I0.3	25	Digital Input	COM-I1.2	NC	GND I1.2	I2.2	34	Digital Input
			COM-I0.2	NC	GND I0.2	I1.2	29	Digital Input	COM-I2.1	NC	GND I2.1
			I0.2	24	Digital Input	COM-I1.1	NC	GND I1.1	I2.1	33	Digital Input
			COM-I0.1	NC	GND I0.1	I1.1	28	Digital Input	COM-I2.0	NC	GND I2.0
			I0.1	23	Digital Input	COM-I1.0	NC	GND 1.0	I2.0	32	Digital Input
			COM-I0.0	NC	GND I0.0	I1.0	27	Digital Input			
			I0.0	22	Digital Input						
AREF	AREF	Arduino PIN	NC	NC	COM- Q (+) ⁺²	NC	NC	COM- Q (+) ⁺²	NC	NC	COM- Q (+) ⁺²
IOREF	IOREF	Arduino PIN	NC	NC	COM- Q (-) ⁺²	NC	NC	COM- Q (-) ⁺²	NC	NC	COM- Q (-) ⁺²
IOREF1	IOREF1	Arduino PIN	Q0.7	6	Analog/PWM /digital Out	Q1.7	9	Analog/PWM/ digital Out	Q2.7	NC	NC
7Vdc (out)	+7Vdc	-							Q2.6	13	Analog/PWM/ digital Out
Gnd	Gnd	GND	Q0.6	5	Analog/PWM /digital Out	Q1.6	7	Analog/PWM/ digital Out			
3.3Vdc (out)	+3.3Vdc	Arduino PIN							Q2.5	12	Analog/PWM/ digital Out
Gnd	Gnd	GND	Q0.5	4	Analog/PWM /digital Out	Q1.5	8	Analog/PWM/ digital Out			
5Vdc (out)	5Vdc	-							Q2.4	NC	NC
gnd	gnd	GND	Q0.4	40	Digital Out ⁺²	Q1.4	45	Digital Out*2	Q2.3	49	Digital Out ⁺²
			Q0.3	39	Digital Out ⁺²	Q1.3	44	Digital Out*2	Q2.2	48	Digital Out ⁺²
			Q0.2	38	Digital Out ⁺²	Q1.2	43	Digital Out*2	Q2.1	47	Digital Out ⁺²
			Q0.1	37	Digital Out ⁺²	Q1.1	42	Digital Out*2	Q2.0	46	Digital Out ⁺²
			Q0.0	36	Digital Out ⁺²	Q1.0	41	Digital Out*2	NC	NC	Digital Out ⁺²
			NC	NC	NC	NC	NC	NC	NC	NC	NC
			NC	NC	NC	NC	NC	NC	Gnd	Gnd	NC
			Gnd	Gnd	Gnd	Gnd	Gnd	Gnd	Gnd	Gnd	Gnd
			Gnd	Gnd	Gnd	Gnd	Gnd	Gnd			Gnd

*NOTE: Digital Inputs I0.5, I0.6, I1.5, I1.6, I2.5, I2.6 can be configured on Arduino IDE to be Interrupts.

Arduino Pin	Switch mode OFF	Switch mode ON
21	SCL	Interrupt 2
20	SDA	Interrupt 3
19	Rx1	Interrupt 4
18	Tx1	Interrupt 5
3	Pin 3	Interrupt 1
2	Pin 2	Interrupt 0

*2 NOTE: Digital Outputs QX.0-QX.4 need to be provided a voltage supply and a reference to the COM-Q(+) and COM-Q(-).



8. Switch configuration

8.1 A Zone

LEFT SIDE		
SWITCH CONFIG		
Arduino Pin	OFF*	ON
21	SCL	I2.6
20	SDA	I2.5
19	Rx1	I1.6
18	Tx1	I1.5
3	Pin 3	I0.6
2	Pin 2	I0.5

*IMPORTANT:

LEFT ZONE. To enable communication connections the switches must be set to “OFF”. Set to “ON” position to enable I/Os PLC connection. Communications and I/Os on the chart can not work simultaneously. For example if SCL is enabled (OFF), I2.6 will not work. OFF position provides direct connection to Arduino Pin (so they can be programmed according to Arduino pin features).

8.2 B, C and D Zones

Some Outputs can be configured as Analg/Digital and 10Vdc/24Vdc, the chart above summarizes the positions for each type of configurable I/O.

RIGHT SIDE		
B ZONE		
Input	ON	OFF
Q0.7 Q0.6 Q0.5 NC	10 Vdc	24 Vdc
Q0.7 Q0.6 Q0.5 NC	Analog	Digital
C ZONE		
Input	ON	OFF
Q1.7 Q1.6 Q1.5 NC	10 Vdc	24 Vdc
Q1.7 Q1.6 Q1.5 NC	Analog	Digital
D ZONE		
Input	ON	OFF
Q2.7 Q2.6 Q2.5 NC	10 Vdc	24 Vdc
Q2.7 Q2.6 Q2.5 NC	Analog	Digital

9. I/O technical details:

M-duino family products



Signal	Vdc	Maxim current consumption
Digital Input	24 Vdc	60mA
Analog/Digital Input configurable		
Analog	0-10Vdc	60mA
Digital	24Vdc	60mA
Digital Output	24Vdc ⁸	200mA
Analog/Digital/PWM Output configurable		
Analog	0-10Vdc	80mA
Digital	24 Vdc	80mA
PWM	24Vdc	80mA
Cumulative outputs	All outputs can be working simultaneously at its max current value	

10. Connector details

The connector inside the PLCs that mounts on the PCB is MC 0,5/10-G-2,5 THT – 1963502 from Phoenix contact. [MC0,5/10-G-2,5THT](#)

For I/O and power supply there is a FK-MC 0,5/10-ST-2,5 - 1881406 connector from Phoenix contact. [FK-MC 0,5/10-ST-2,5](#).

Connection details:

⁸ You can select 24Vdc or 10Vdc (with correctly switch configuration). Digital output connect PLC to 12Vdc power supply





Article reference	MC 0,5/10-G-2,5 THT
Height	8,1mm
Pitch	2,5mm
Dimension	22,5mm
Pin dimensions	0,8x0,8mm
Pin spacing	2,50mm

Article refernce	FK-MC 0,5/10-ST-2,5
Rigid conduit section min.	0,14 mm ²
Rigid conduit section max.	0,5 mm ²
Flexible conduit section min.	0,14 mm ²
Flexible conduit section max.	0,5 mm ²
Conduit section AWG/kcmil min.	26
Conduit section AWG/kcmil max.	20

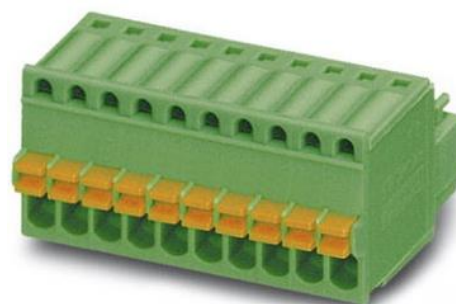



11. Connection type

11.1 Digital Inputs

Connection digital Inputs (24Vdc)

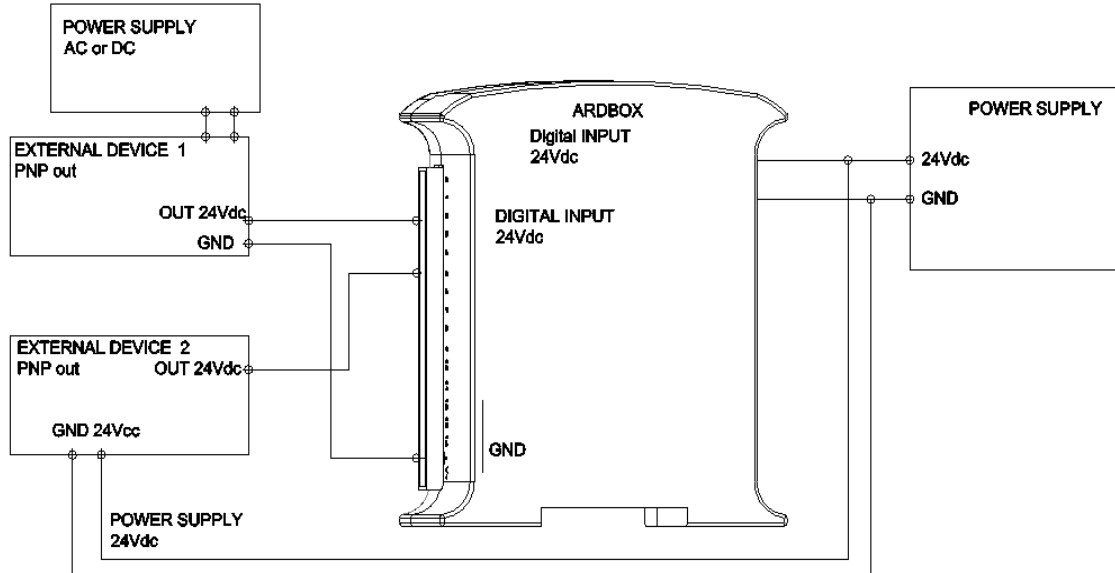

NOTE:

Some digital Inputs have an isolated signal. In this case is necessary to connect correctly ground (GND) in correctly "com" pin.

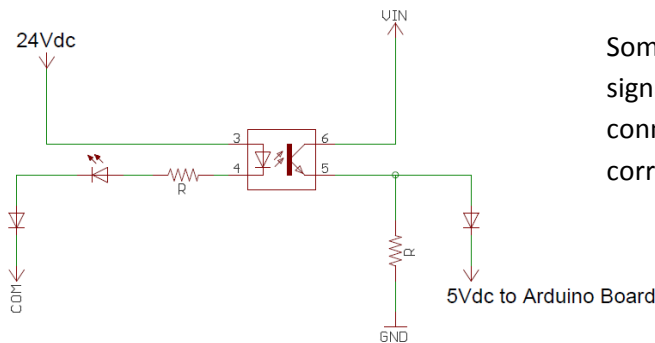

- Programation Code (example):

```
int I01 = 12; // Digital (24Vdc)
void setup() {
  pinMode(I01, INPUT);
}
Void loop(){
  /* Lo que se quiera */ = digitalRead(I01);
}
```



11.2 Analog (0-10Vdc) / Digital Inputs “configurable”

Analog configuration mode:

Connection analog Inputs (0-10Vdc)

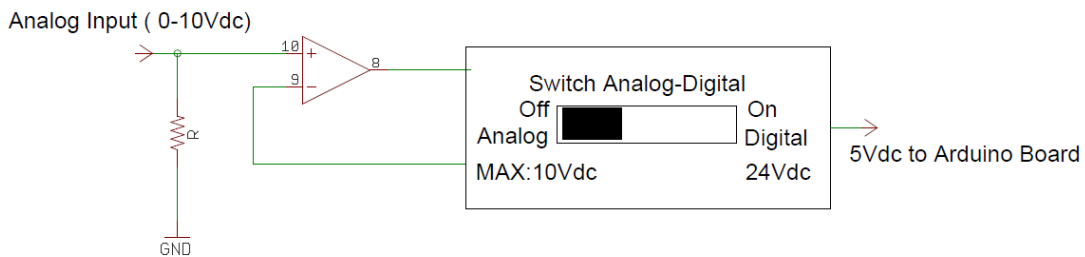
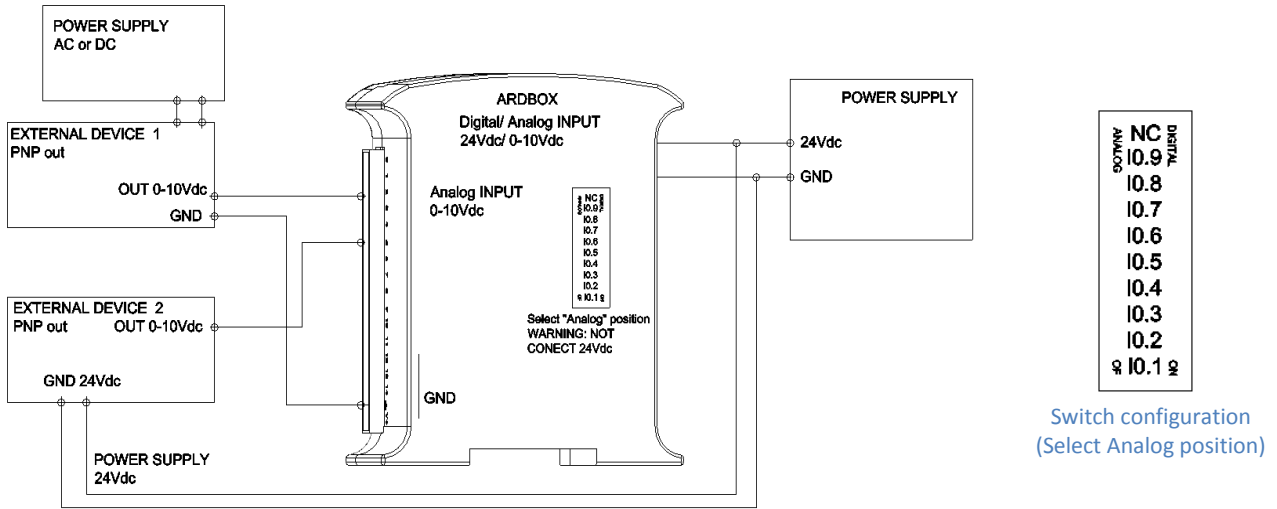

- Programation Code (example):

```
int IO1 = A05; // select the Analog (0-10Vdc) / Digital (24Vdc)IN /**warning** (if Analog selection connect 10Vdc MAX).
int IO2 = A04; // select the Analog (0-10Vdc) / Digital (24Vdc)IN /**warning** (if Analog selection connect 10Vdc MAX).
void setup() {
  pinMode(IO1, INPUT);
}
void loop(){
  value = analogRead(A5);
  /* Lo que se quiera */ = digitalRead(IO1);
}
```



Digital configuration mode:

Connection digital Inputs (24Vdc)

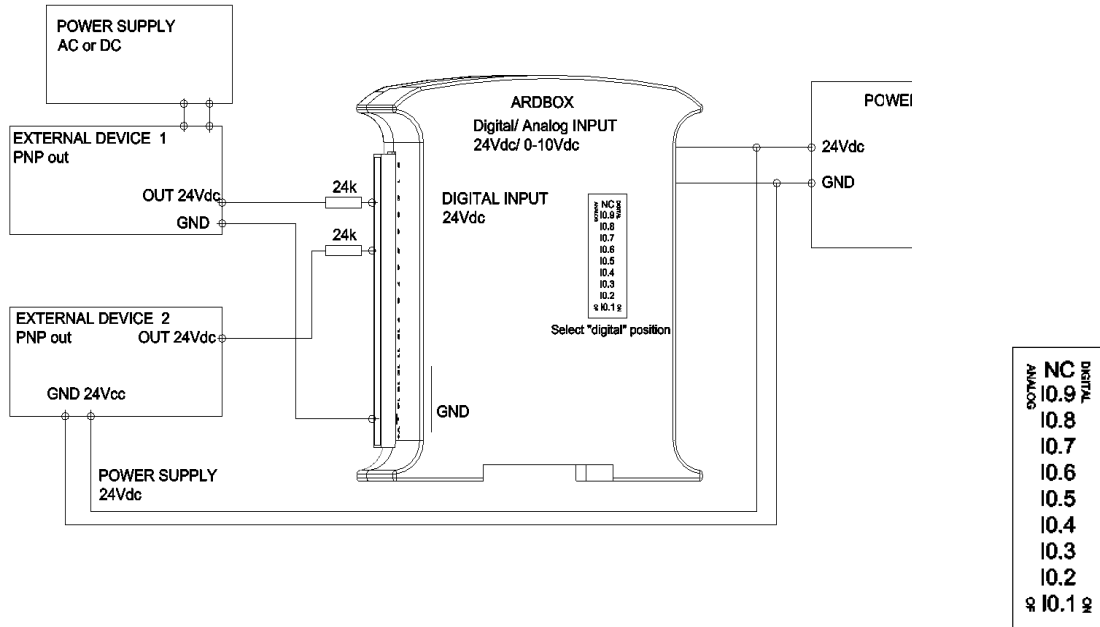

Switch configuration (Select digital position)

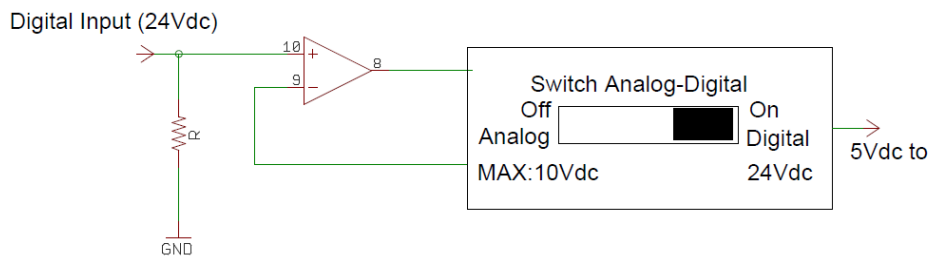

- Programation Code (example):

```
int I01 = A05; // select the Analog (0-10Vdc) / Digital (24Vdc)IN /**warning** (if Analog slection connect 10Vdc MAX).
int I02 = A04; // select the Analog (0-10Vdc) / Digital (24Vdc)IN /**warning** (if Analog slection connect 10Vdc MAX).
void setup() {
  pinMode(I01, INPUT);
}
Void loop(){
  value = analogRead(A5);
  /* Lo que se quiera */ = digitalRead(I01);
}
```



11.3 Digital Outputs

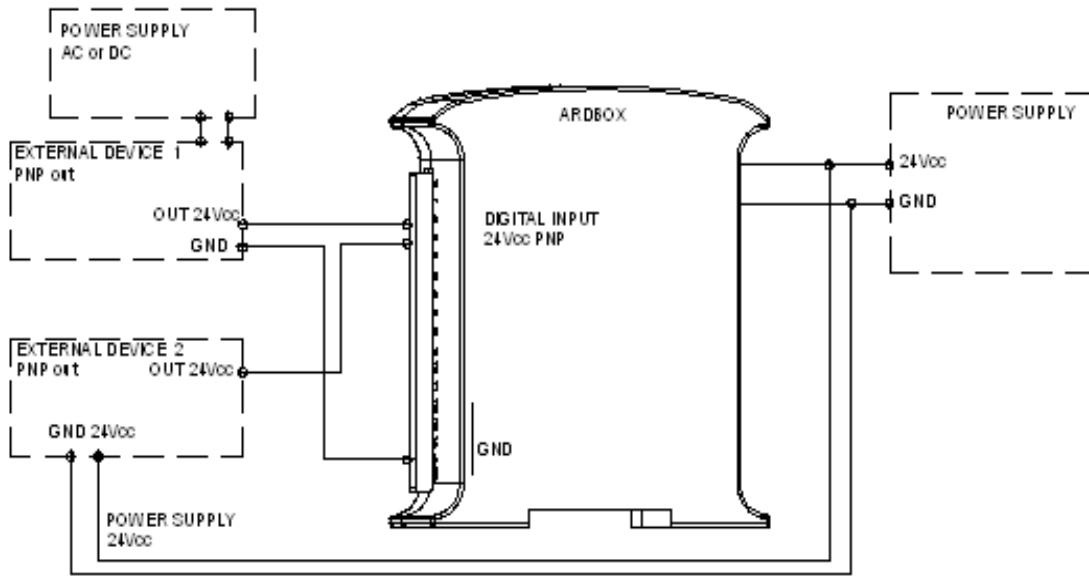

5Vdc Output from the Arduino Board

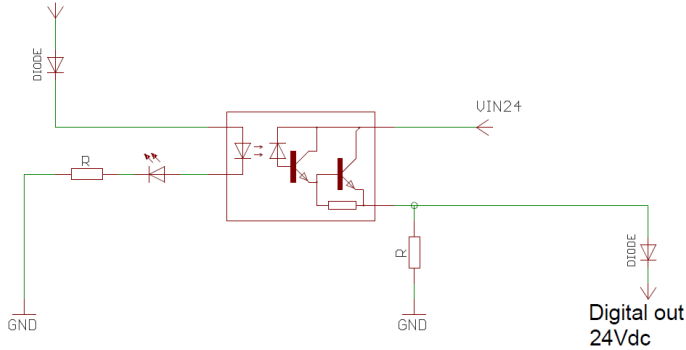

- Programation Code (example):

```

int Q06 = 3; // Relay output (220Vac, 5A)
void setup() {
  pinMode(Q06, OUTPUT);
}
void loop(){
  digitalWrite(Q06, HIGH); // Relay ON
  // turn the LED on (HIGH is the voltage level)
  delay(1000); // wait for a second
  digitalWrite(Q06, LOW); // Relay OFF
  // turn the LED off (LOW is the voltage level)
}

```



11.4 Analog (0-10Vdc) / PWM / Digital Outputs “configurable”

Analog configuration mode:

Connection analog Output (0-10Vdc)

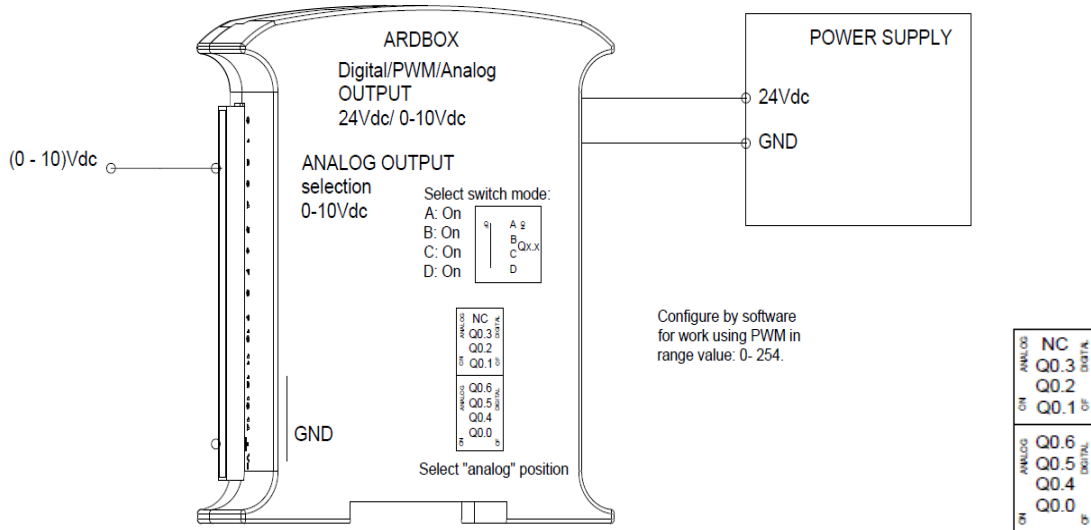

Switch configuration
 Select 10Vdc position switch
 Select Analog position switch

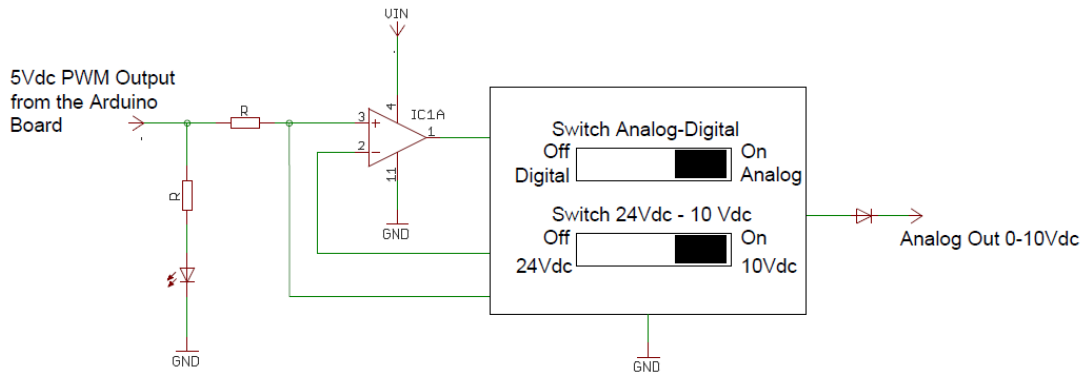

- Programation Code (example):

```
int Q06 = 3;
// select the Analog (0-10Vdc) / PWM (10 OR 24Vdc) / Digital //(24Vdc)OUTPUT
int Q05 = 5;
// select the Analog (0-10Vdc) / PWM (10 OR 24Vdc) / Digital //(24Vdc)OUTPUT
void setup() {
  pinMode(Q06, OUTPUT);
  pinMode(Q05, OUTPUT);
}
void loop(){
  analogWrite(Q06, /*valor de una variable */);
  digitalWrite(Q05, 125);
}
```



Digital configuration mode:

Connection Digital Output (24Vdc)

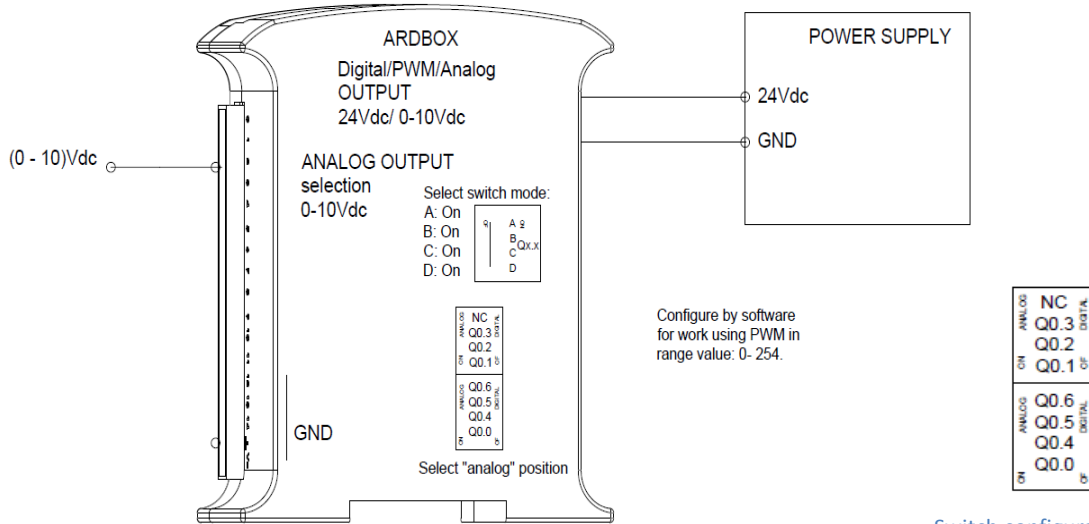

Switch configuration
Select 24Vdc position switch
Select Digital position switch

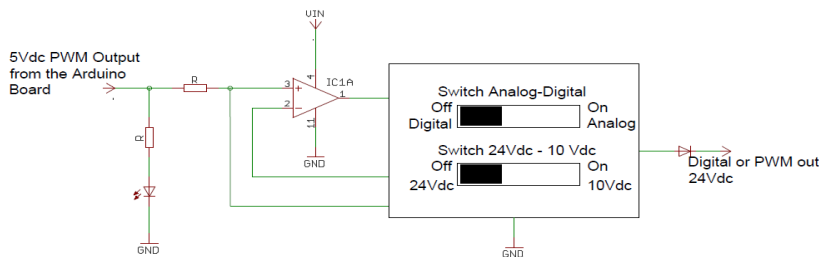

- Programation Code (example):

```
int Q06 = 3;
// select the Analog (0-10Vdc) / PWM (10 OR 24Vdc) /Digital //(24Vdc)OUTPUT
int Q05 = 5;
// select the Analog (0-10Vdc) / PWM (10 OR 24Vdc) /Digital //(24Vdc)OUTPUT
void setup() {
  pinMode(Q06, OUTPUT);
  pinMode(Q05, OUTPUT);
}
void loop(){
  analogWrite(Q06, 254);
  digitalWrite(Q05, HIGH); // Relay ON
  // turn the LED on (HIGH is the voltage level)
  delay(1000); // wait for a second
  analogWrite(Q06, 0);
  digitalWrite(Q05, LOW); // Relay OFF
  // turn the LED off (LOW is the voltage level)
}
```



PWM configuration mode:

Connection PWM Output (24Vdc)

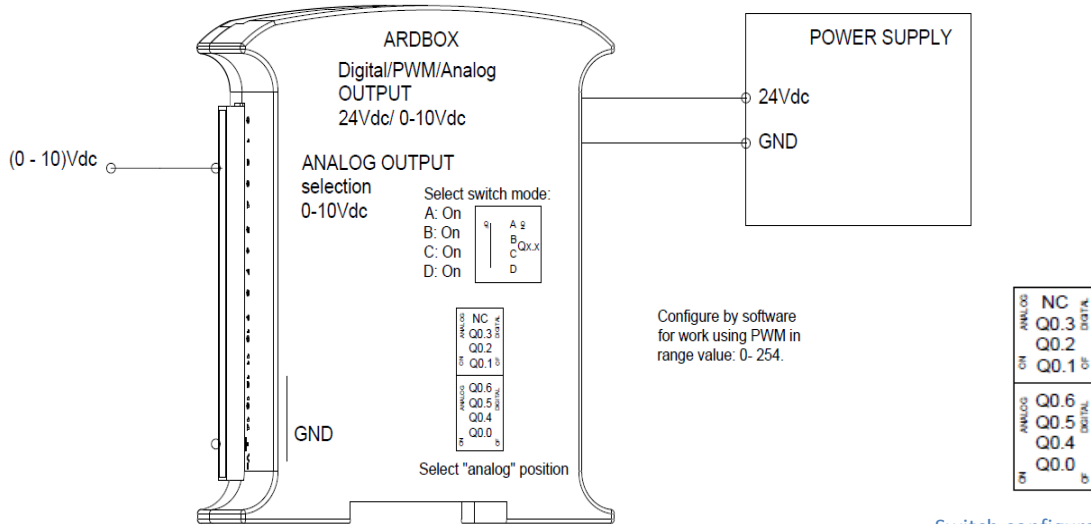

Switch configuration
 Select 24Vdc position switch
 Select Digital position switch

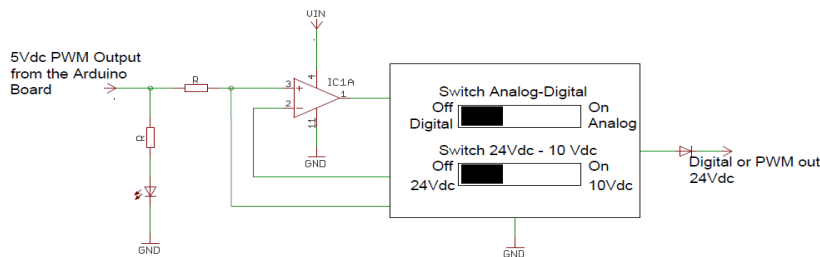

- Programation Code (example):

```

int Q06 = 3;
// select the Analog (0-10Vdc) / PWM (10 OR 24Vdc) /Digital //(24Vdc)OUTPUT
int Q05 = 5;
// select the Analog (0-10Vdc) / PWM (10 OR 24Vdc) /Digital //(24Vdc)OUTPUT
void setup() {
  pinMode(Q06, OUTPUT);
  pinMode(Q05, OUTPUT);
}
void loop(){
  analogWrite(Q06, /*valor de una variable */);
  digitalWrite(Q05, 125);
}

```



11.5 Relay Outputs

Connection Relay Output

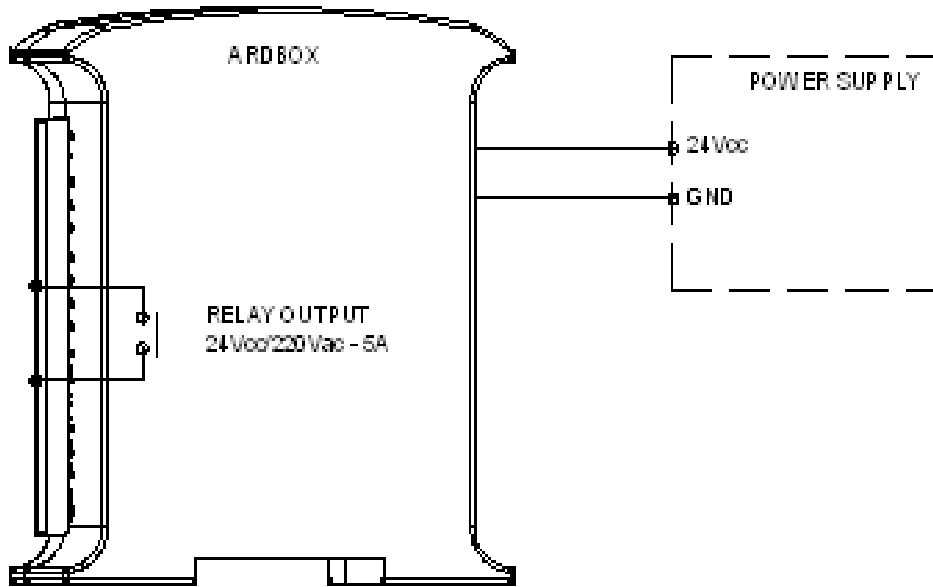

- Programation Code (example):

```
int Q06 = 3; // Relay output (220Vac, 5A)
void setup() {
  pinMode(Q06, OUTPUT);
}
void loop(){
  digitalWrite(Q06, HIGH); // Relay ON
  delay(1000); // wait for a second
  digitalWrite(Q06, LOW); // Relay OFF
}
```



12. Communication Pinout

In A Zone you can select different types of Arduino communication PINS:

Arduino Pin	Switch mode OFF	Switch mode ON
21	SCL	I2.6
20	SDA	I2.5
19	Rx1	I1.6
18	Tx1	I1.5
3	Pin 3	I0.6
2	Pin 2	I0.5

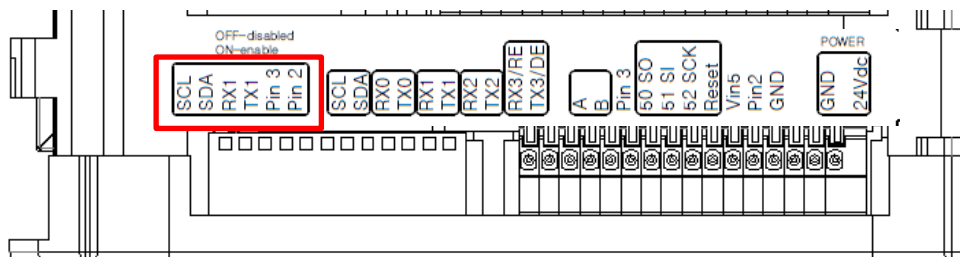

*IMPORTANT:

LEFT ZONE. To enable communication connections the switches must be set to “OFF”. Set to “ON” position to enable I/Os PLC connection. Communications and I/Os on the chart can not work simultaneously. For example if SCL is enabled (OFF), I2.6 will not work. OFF position provides direct connection to Arduino Pin (so they be programmed according to Arduino pin features).

For RS485 communication protocol the defined Arduino Mega pins are showed in the chart below.

RS485 pinout	
Function	Arduino Pin
DI	10
RO	11
RE	15
DE	14

You have different options and accessories. M-Duino family products have direct Ethernet port with RJ45 connector.

For I2C/RS232 communication, M-Duino family products are directly connected to Arduino Mega Board. In order to implement this communication an accessory is required.

<http://www.industrialshields.com/accesories>



13. Mechanical Characteristics

- Dimension M-duino Family:

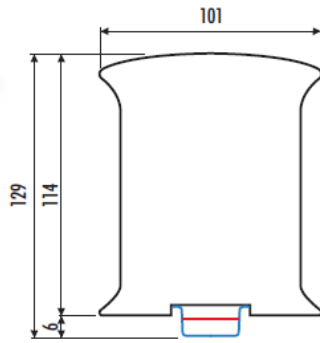

- DIN rail mounting:

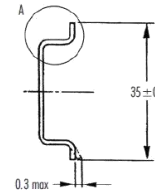
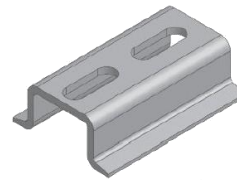

Profilato a cappello TH 35-7,5
Top hat rail TH 35-7,5

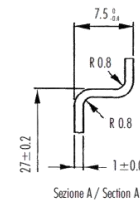

Sezione A / Section A

Profilato a cappello TH 35-15
Top hat rail TH 35-15

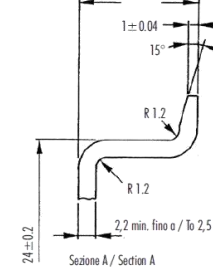

Sezione A / Section A



CARATTERISTICHE	METODO	UNITA' DI MISURA	BLEND PC/ABS
Mecaniche			
Resistenza a trazione allo staccamento	ASTM D638	MPa	68
Resistenza a trazione a rottura	ASTM D638	MPa	48
Allungamento a rottura	ASTM D638	%	59
Modulo in flessione	ASTM D790	MPa	2894
Prova Load con intaglio	ISO 180/14	KJ/m ²	5.5
Termiche			
Temp. di ammorbidimento Vicat, metodo B	ASTM D1525	°C	114
Temperatura Ricetta 1.81 MPa	ASTM D448	°C	97
Fisiche			
Peso specifico	ASTM D792	gr/cm ³	1.21
Ritiro nello stampo	ASTM D955	%	0.4/0.6
Melt Flow Index 260°C - 99N	ASTM D1238	gr/10'	11.1
Comportamento alla fiamma			
Autosostentanza (min di spessore)	UL94	-	V-0 (0.8)
Filo Inamidazione 3.2 mm	IEC 695.2.1	°C	980

Italtronic si riserva il diritto di modificare il materiale con cui realizza i propri prodotti senza obbligo di preavviso.

FEATURES	TEST METHOD	UNITS	BLEND PC/ABS
Mechanical test			
Resistance to tensile stress at yield	ASTM D638	MPa	68
Tensile strength	ASTM D638	MPa	48
Ultimate elongation	ASTM D638	%	59
Flexing modulus	ASTM D790	MPa	2894
Load test notched	ISO 180/14	KJ/m ²	5.5
Thermal test			
Vicat softening temperature method B	ASTM D1525	°C	114
Reheating temperature 1.81 MPa	ASTM D448	°C	97
Physical test			
Specific gravity	ASTM D792	gr/cm ³	1.21
Mold shrinkage	ASTM D955	%	0.4/0.6
Melt Flow Index 260°C - 99N	ASTM D1238	gr/10'	11.1
Flame test			
Self extinguishing (thickness in mm)	UL94	-	V-0 (0.8)
Inamidation thread 3.2 mm	IEC 695.2.1	°C	980

Italtronic can operate any change of the materials without being obliged to forewarn.



14. Software Interface:

Arduino IDE is compatible for program these PLCs. You must to download a start code in www.industrialshields.com at product page in “document files”section and then It’s necessary open it with Arduino IDE.

Configuration about Arduino IDE:

All Ardbox PLCs use an Arduino Leonardo and you need to choose these opcion in Arduino IDE.

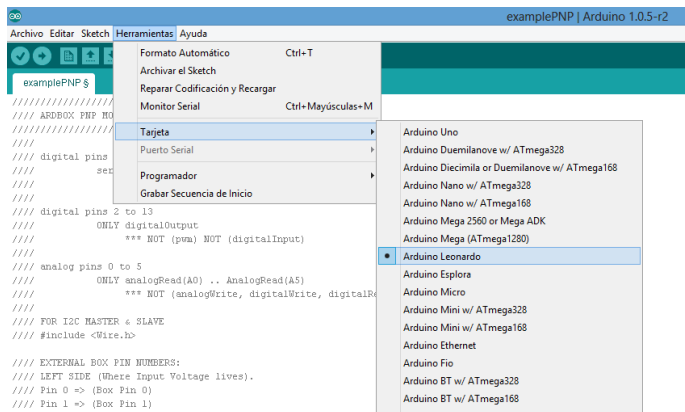

About Industrial Shields:

SPAIN

Avda. Castell de Barberà 26, nave 9

08210 Barberà del Vallès (Barcelona)

Tel.+34 635693611

Mail: industrialshields@industrialshields.com