

DETAILS

Product Number	C10754_CUTE-3-SS
Family	Cute
Type	Lens array
Color	clear
Diameter	35 mm
Height	15 mm
Style	round
Optic Material	PMMA
Holder Material	
Fastening	pin, glue
Status	ready
ROHS Compliant	Yes
Date Updated	7/03/2014



OPTICAL PROPERTIES

LED	Viewing Angle	Light Beam	Efficiency	cd/lm	Connector
XM-L HVW	sim: 19	Smooth spo...	.87 %	-	-
XT-E HVW	sim: 15	Smooth spo...	.88 %	-	-
Oslon SSL 80	10 deg	Smooth spo...	.90 %	15.220	-
Z5	10 deg	Smooth spo...	-	sim: 0.000	-
XP-E	11 deg	Smooth spo...	.93 %	15.390	-
LUXEON Rebel	12 deg	Smooth spo...	.91 %	12.200	-
NCSxx19A	12 deg	Smooth spo...	.89 %	-	-
C3535 (Intematix)	12 deg	Smooth spo...	.90 %	-	-
XT-E	12 deg	Smooth spo...	.88 %	8.700	-
LUXEON Rebel ES	13 deg	Smooth spo...	.91 %	-	-
Oslon SSL 150	13 deg	Smooth spo...	-	sim: 0.000	-
LUXEON A	13 deg	Smooth spo...	.91 %	-	-
NVSxx19A	14 deg	Smooth spo...	.89 %	-	-
XP-G2	14 deg	Smooth spo...	.89 %	11.800	-
H35C1 (LEMWA33)	14 deg	Smooth spo...	.86 %	10.900	-
Z5M1/Z5M2	14 deg	Smooth spo...	.88 %	11.700	-
XP-G	15 deg	Smooth spo...	.93 %	9.540	-
Oslon Square EC	17 deg	Smooth spo...	.83 %	8.540	-
XM-L	19 deg	Smooth spo...	.91 %	5.280	-
XM-L2	20 deg	Smooth spo...	.90 %	6.400	-

Relative intensity of C10754_CUTE-3-SS-(XPG2)

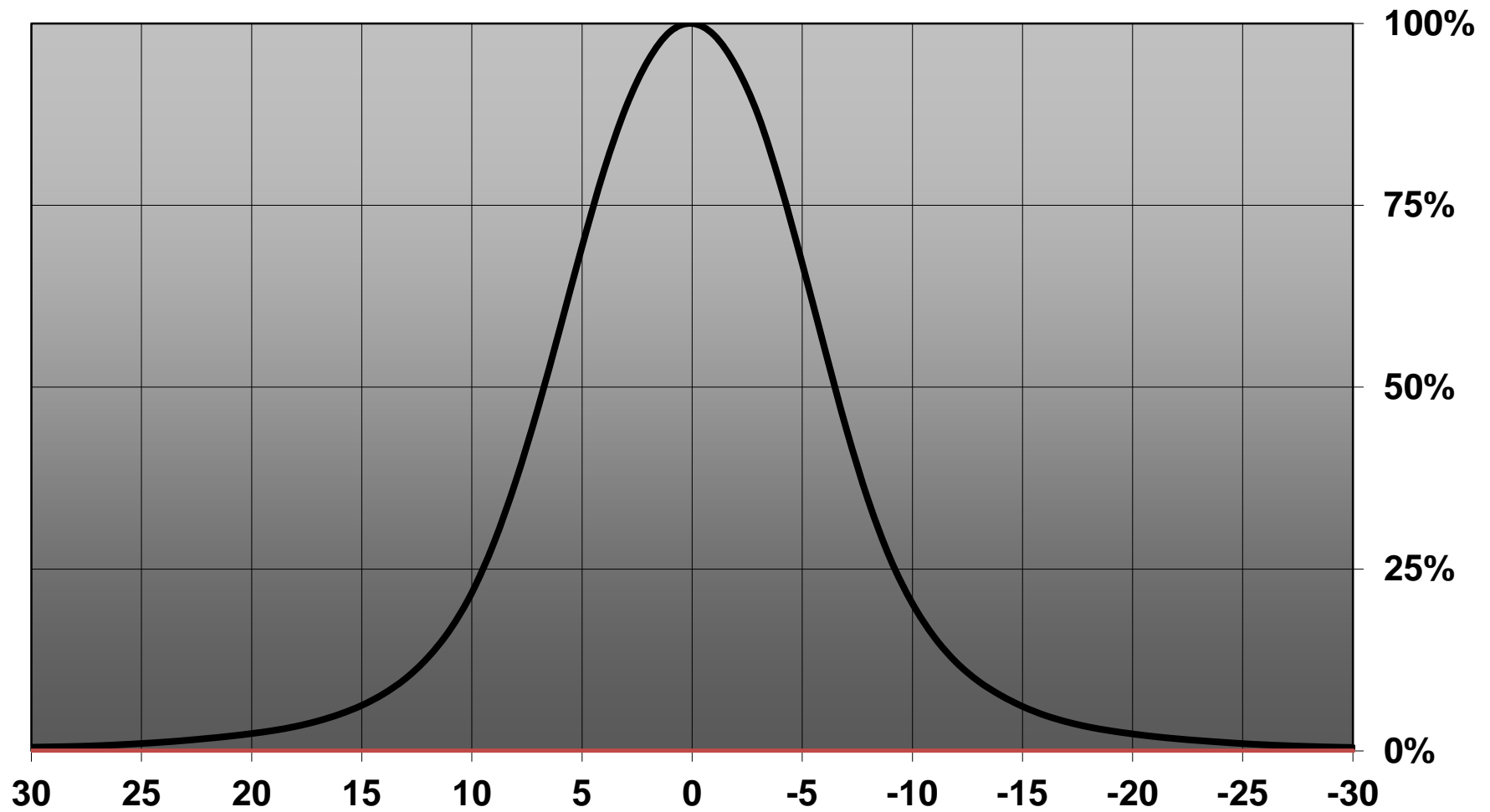

D

C

B

A

4

3

2

1

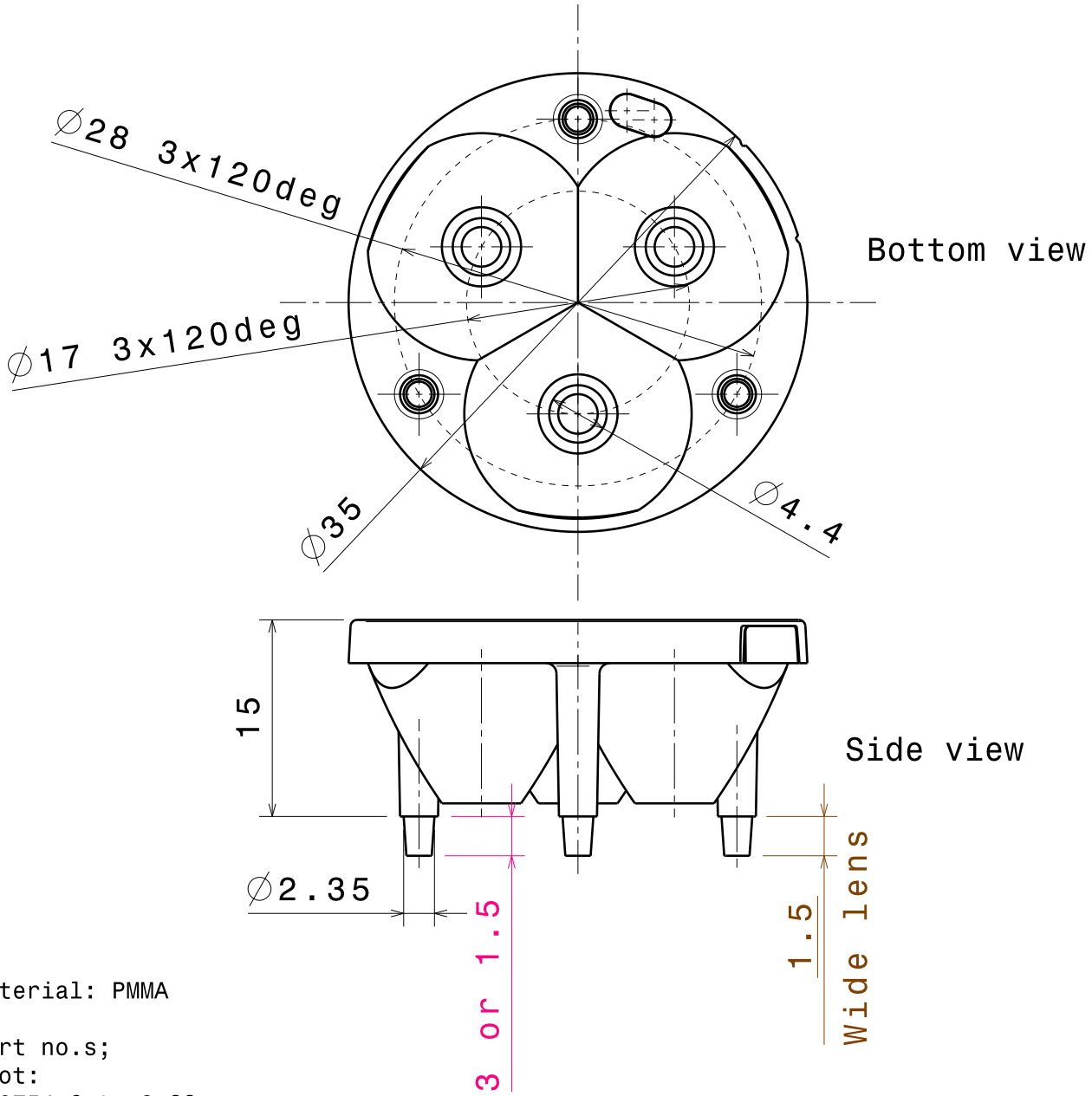

Material: PMMA

Part no.s;

Spot:

C10754_Cute-3-SS

C11333_Cute-3-SS, pin head length =1.5mm

Medium:

C10755_Cute-3-M

C11334_Cute-3-M, pin head length =1.5mm

Wide:

C10756_Cute-3-W

This drawing is our property. It can't be reproduced or communicated without our written agreement.



Ledil Oy
Tehdaskatu 13
FIN-24100 SALO
Finland

DRAWING TITLE

Datasheet Cute-3 Lens Series

DRAWN BY

pv

DATE

08.02.2010

CHECKED BY

TK

DATE

09.09.2008

SIZE

A4

DRAWING NUMBER

REV

1

DESIGNED BY

HH

DATE

09.09.2008

SCALE

2:1

WEIGHT (g)

SHEET

1/1

D

A

1

Ledil Oy C10754_Cute-3-SS-XP C10754_Cute-3-SS-XP / LDC (Linear)

Luminaire: Ledil Oy C10754_Cute-3-SS-XP C10754_Cute-3-SS-XP
Lamps: 3 x Cree XP-E (White)

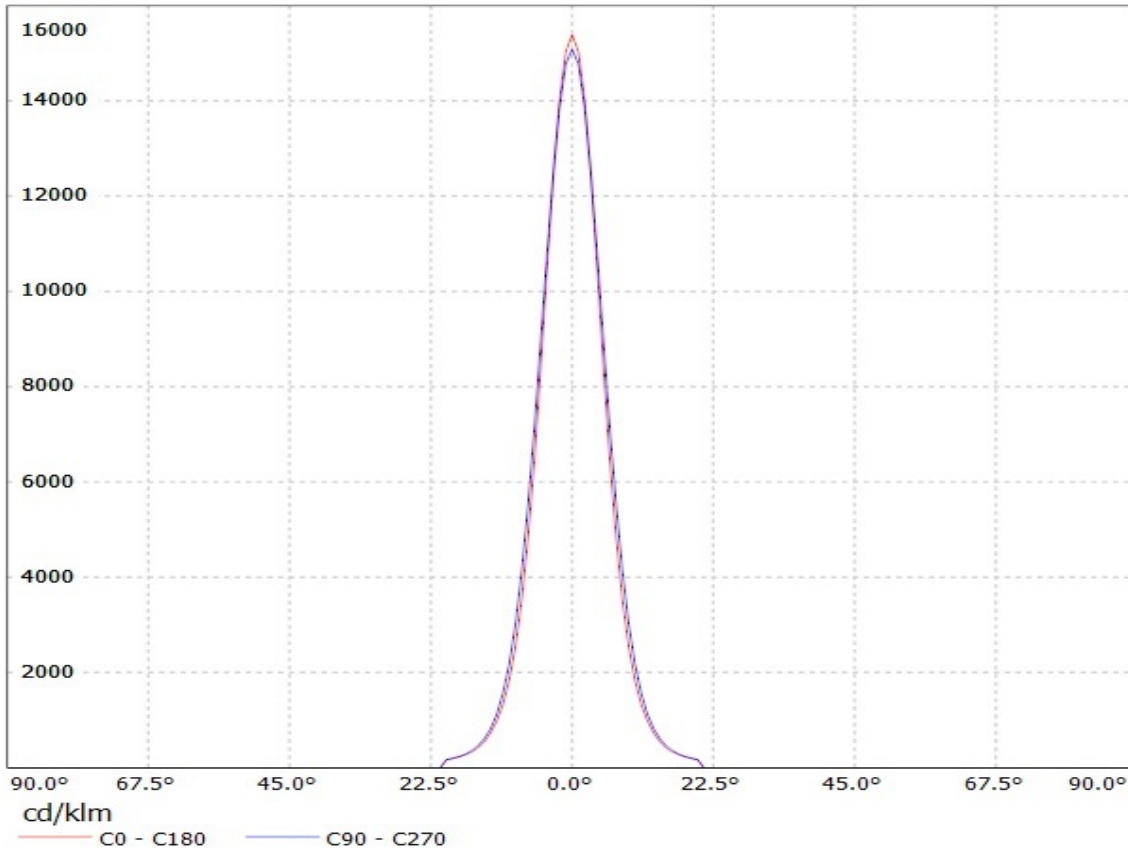

Ledil Oy C10754_Cute-3-SS-RE (Luxeon Rebel) C10754_Cute-3-SS-RE (Luxeon Rebel) / LDC (Linear)

Luminaire: Ledil Oy C10754_Cute-3-SS-RE (Luxeon Rebel) C10754_Cute-3-SS-RE (Luxeon Rebel)
Lamps: 1 x Luxeon Rebel 250mA 255.2lm

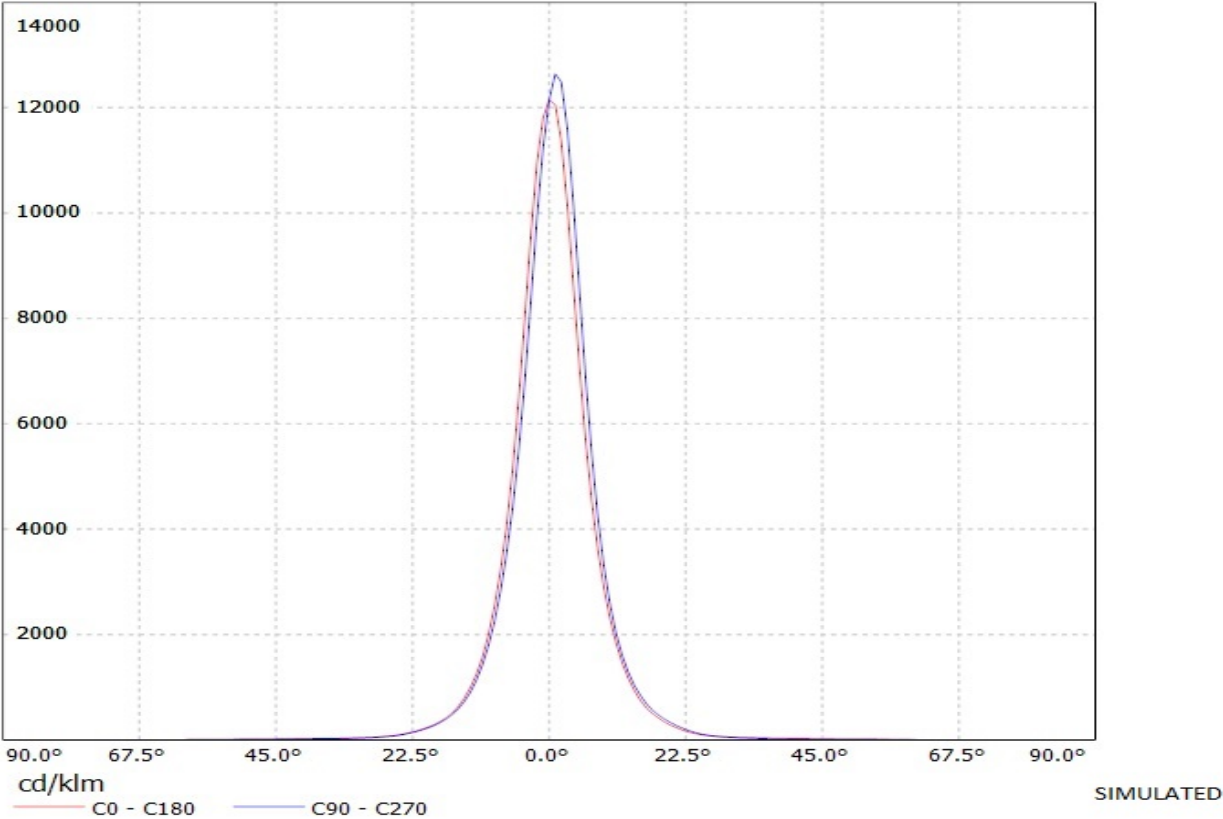

Luminaire: LEDil Oy C10754_CUTE3-SS_(XT-E) Efficiency=88%
Lamps: 1 x CRee XT-E (XTEAWT-00-0000-00000HBE8) 218lm @ 250mA CCT=2800K P=2.2W I=250mA

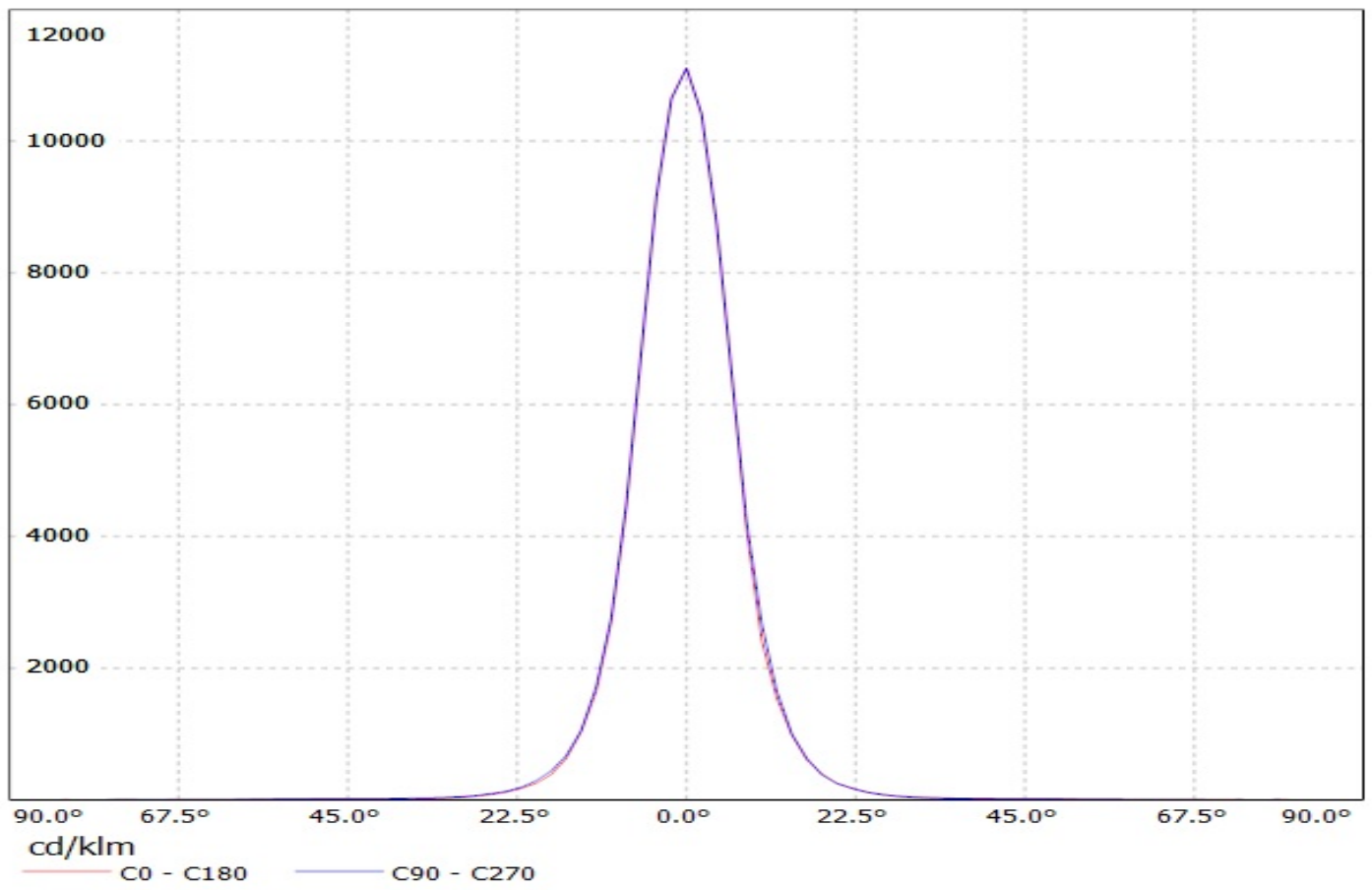

Luminaire: Ledil Oy C10754_CUTE-3-SS (Osram Oslon 150 degree 266Lm @ 250mA)
Lamps: 1 x Osram Oslon 150 degree 266Lm @ 250mA

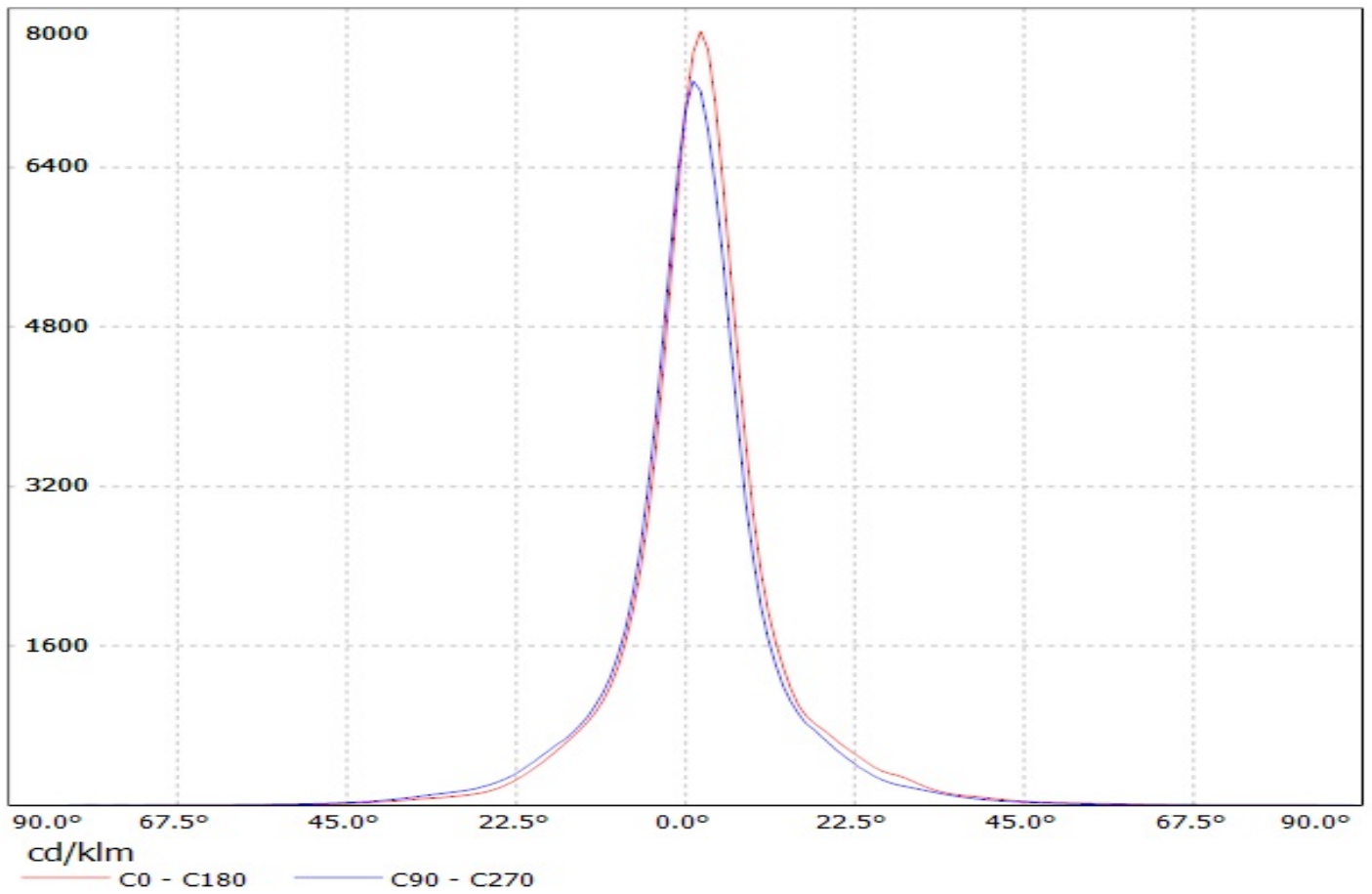

Luminaire: Ledil Oy C10754_Cute-3-SS_(3535_Ceramic_gen2) Efficiency=86%
Lamps: 1 x Lg 3535 Ceramic gen2 (PKG5700K) 343lm @ 250mA CCT=6100K P=2.2W I=250mA

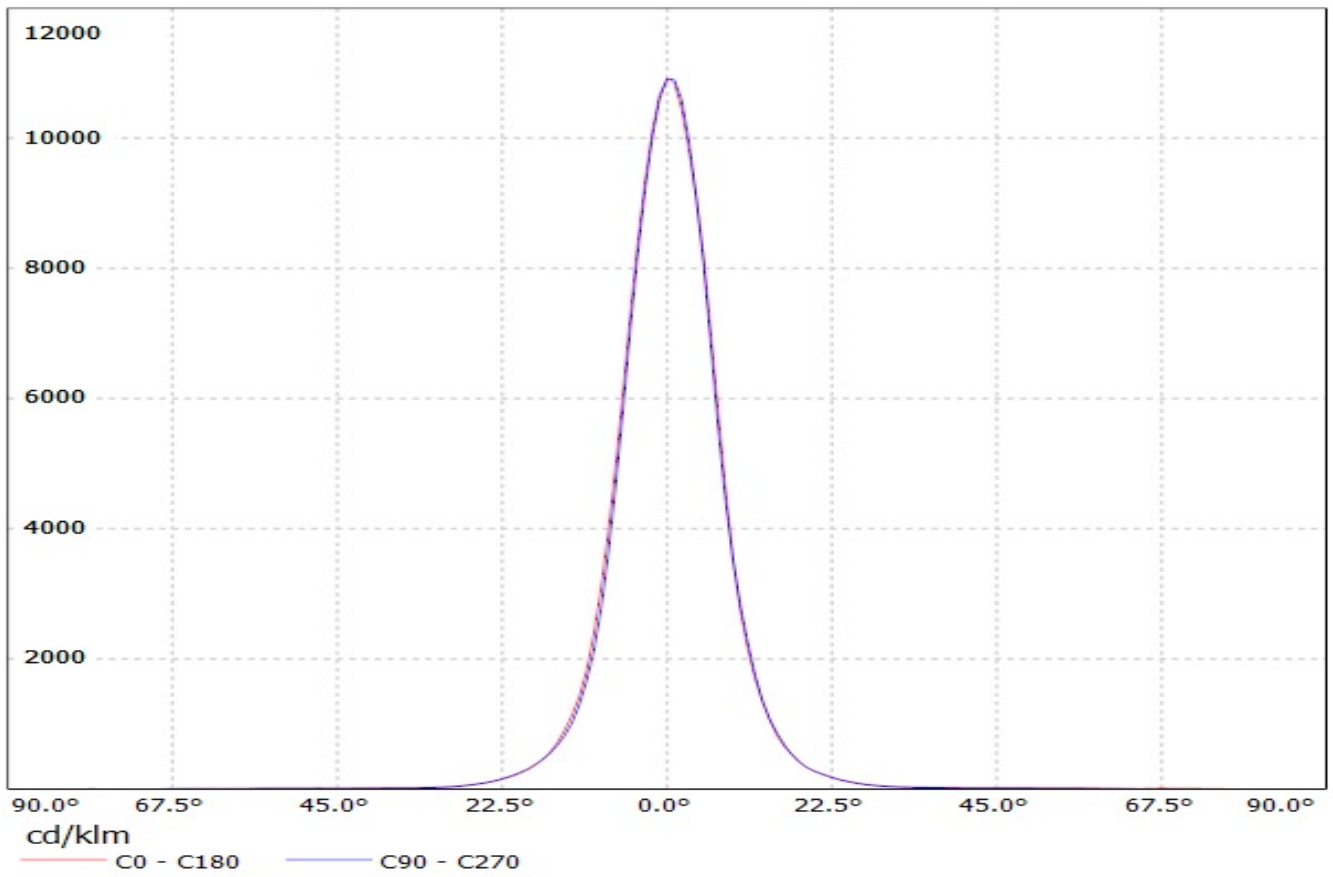

Luminaire: LEDil Oy C10754_CUTE-3-SS_(Z5M1) Efficiency=88%
Lamps: 1 x Seoul Z5M1 (SZ5-M1-WN-C8) 286lm @ 250mA CCT=4500K P=2.2W I=250mA

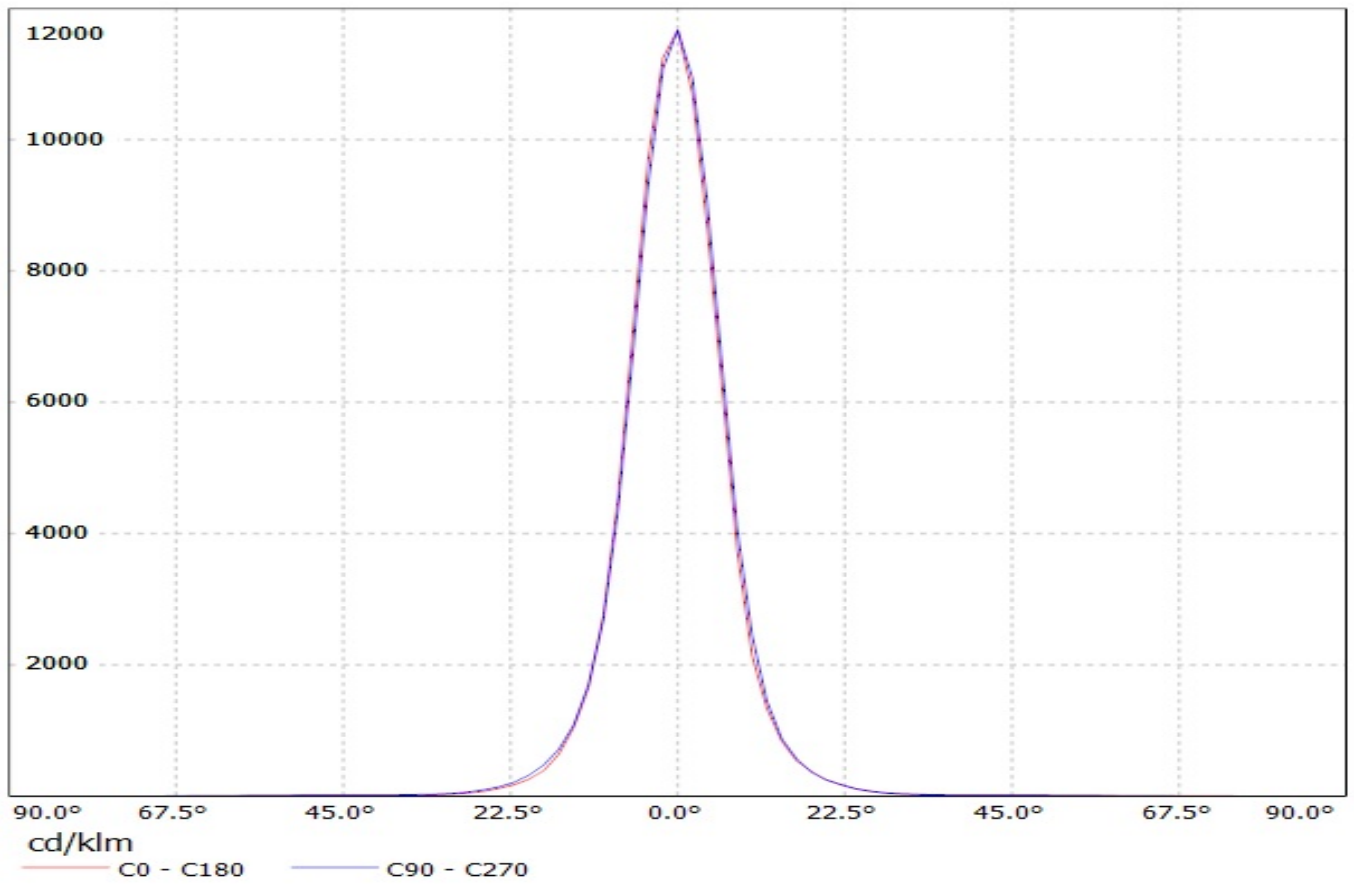

Ledil Oy C10755_Cute-3-M-XP-G C10755_Cute-3-M-XP-G / LDC (Linear)

Luminaire: Ledil Oy C10755_Cute-3-M-XP-G C10755_Cute-3-M-XP-G
Lamps: 3 x Cree XP-G (White)

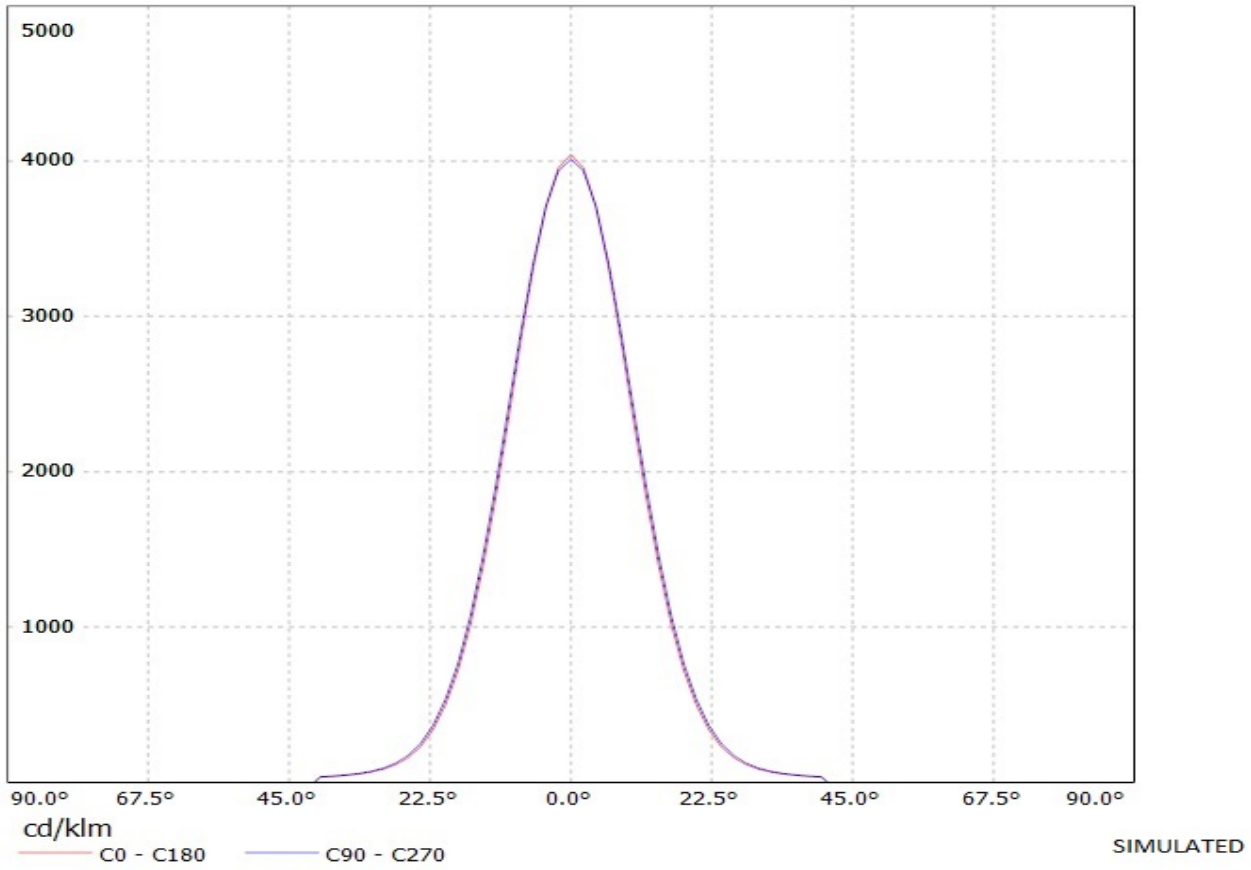

Ledil Oy C10755_Cute-3-M-XM C10755_Cute-3-M-XM / LDC (Linear)

Luminaire: Ledil Oy C10755_Cute-3-M-XM C10755_Cute-3-M-XM
Lamps: 1 x Cree XM-L x3

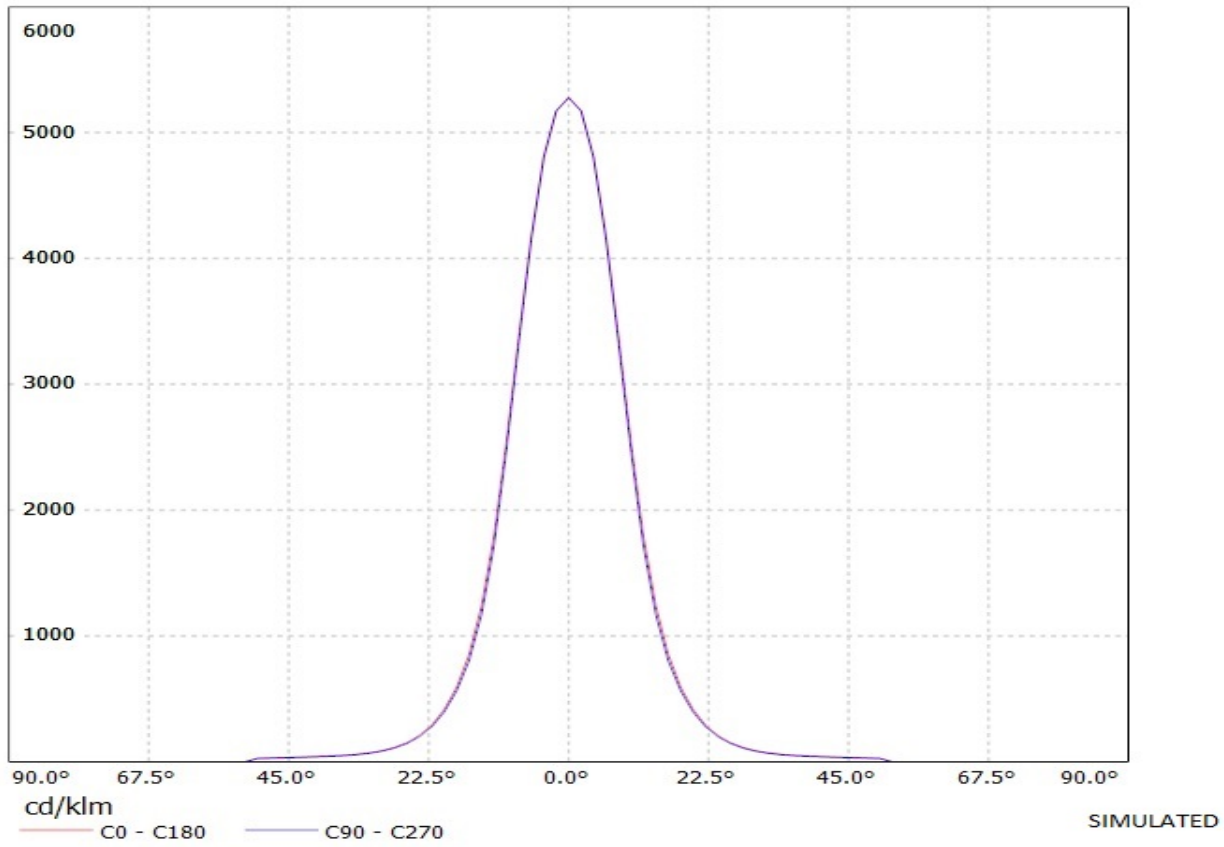

Luminaire: LEDil Oy C10754_CUTE-3-SS_(XM-L2) Efficiency=90%
Lamps: 1 x Cree XM-L2 (XMLBWT-0-7B4-T30-0L-0001) 268lm @ 250mA CCT=3200K P=2.1W I=250mA

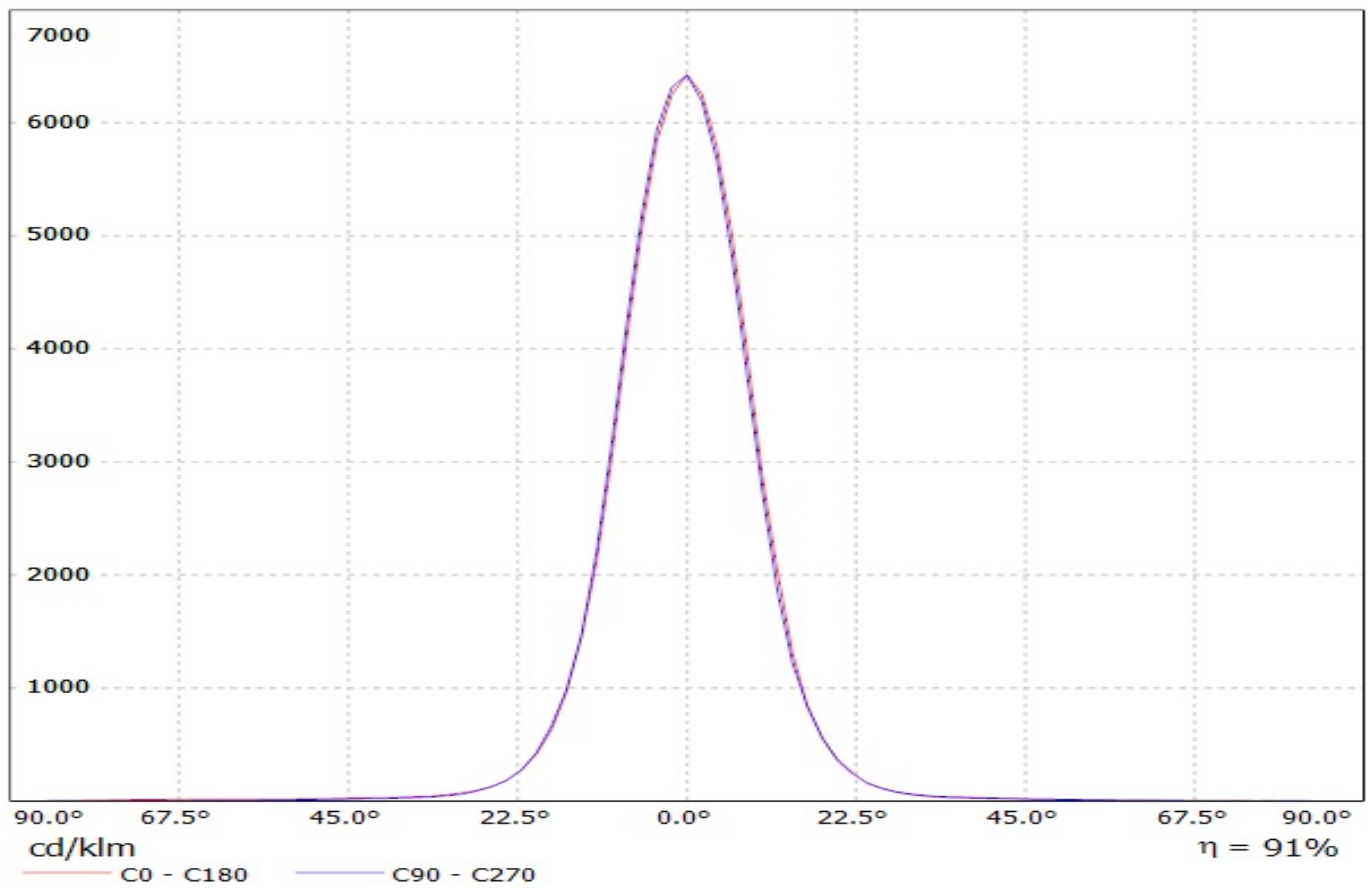

Ledil Oy C10754_Cute-3-SS-XP C10754_Cute-3-SS-XP / LDC (Polar)

Luminaire: Ledil Oy C10754_Cute-3-SS-XP C10754_Cute-3-SS-XP
Lamps: 3 x Cree XP-E (White)

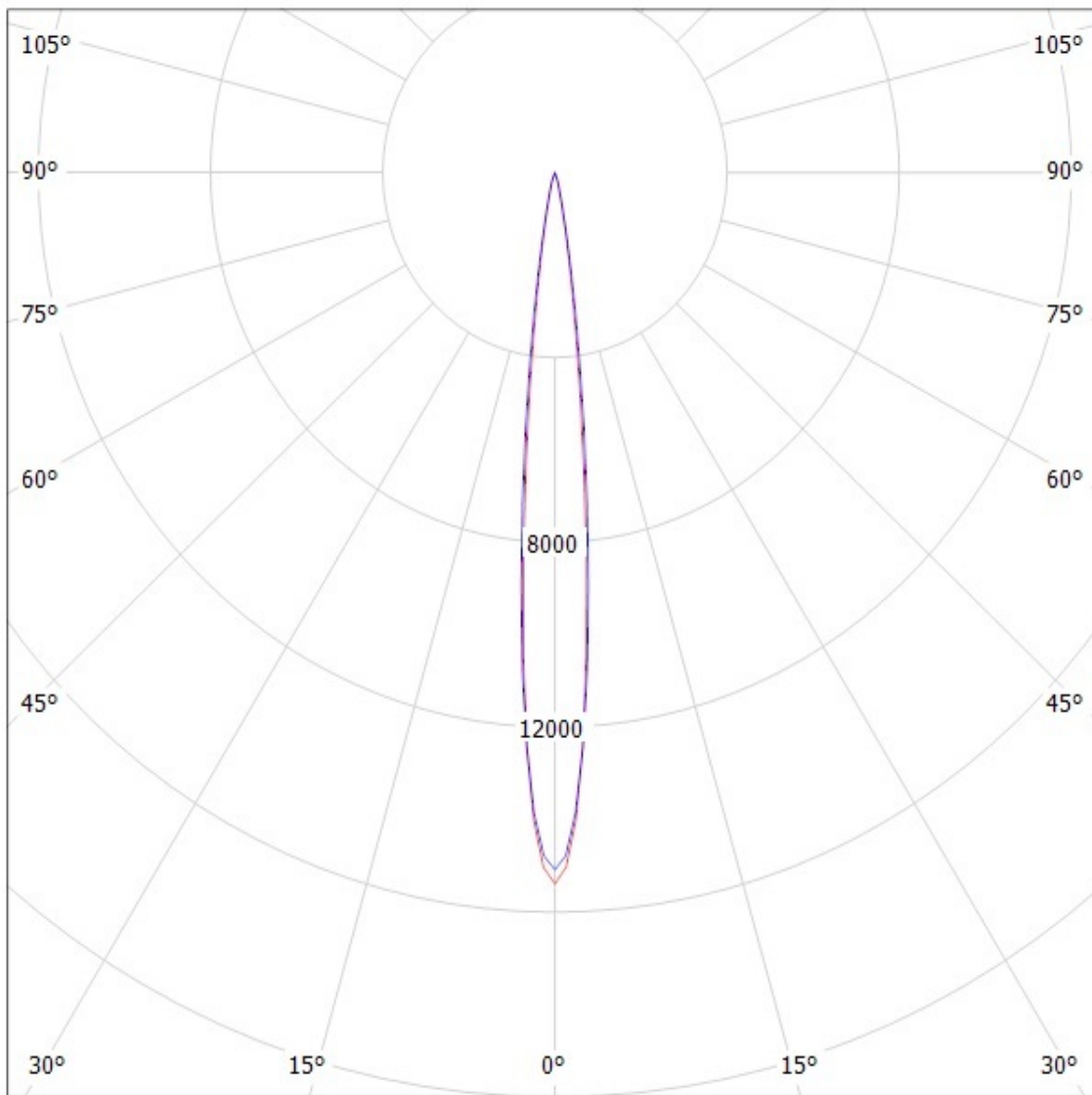

cd/klm

— C0 - C180

— C90 - C270

SIMULATED

Ledil Oy C10754_Cute-3-SS-RE (Luxeon Rebel) C10754_Cute-3-SS-RE (Luxeon Rebel) / LDC (Polar)

Luminaire: Ledil Oy C10754_Cute-3-SS-RE (Luxeon Rebel) C10754_Cute-3-SS-RE (Luxeon Rebel)
Lamps: 1 x Luxeon Rebel 250mA 255.2lm

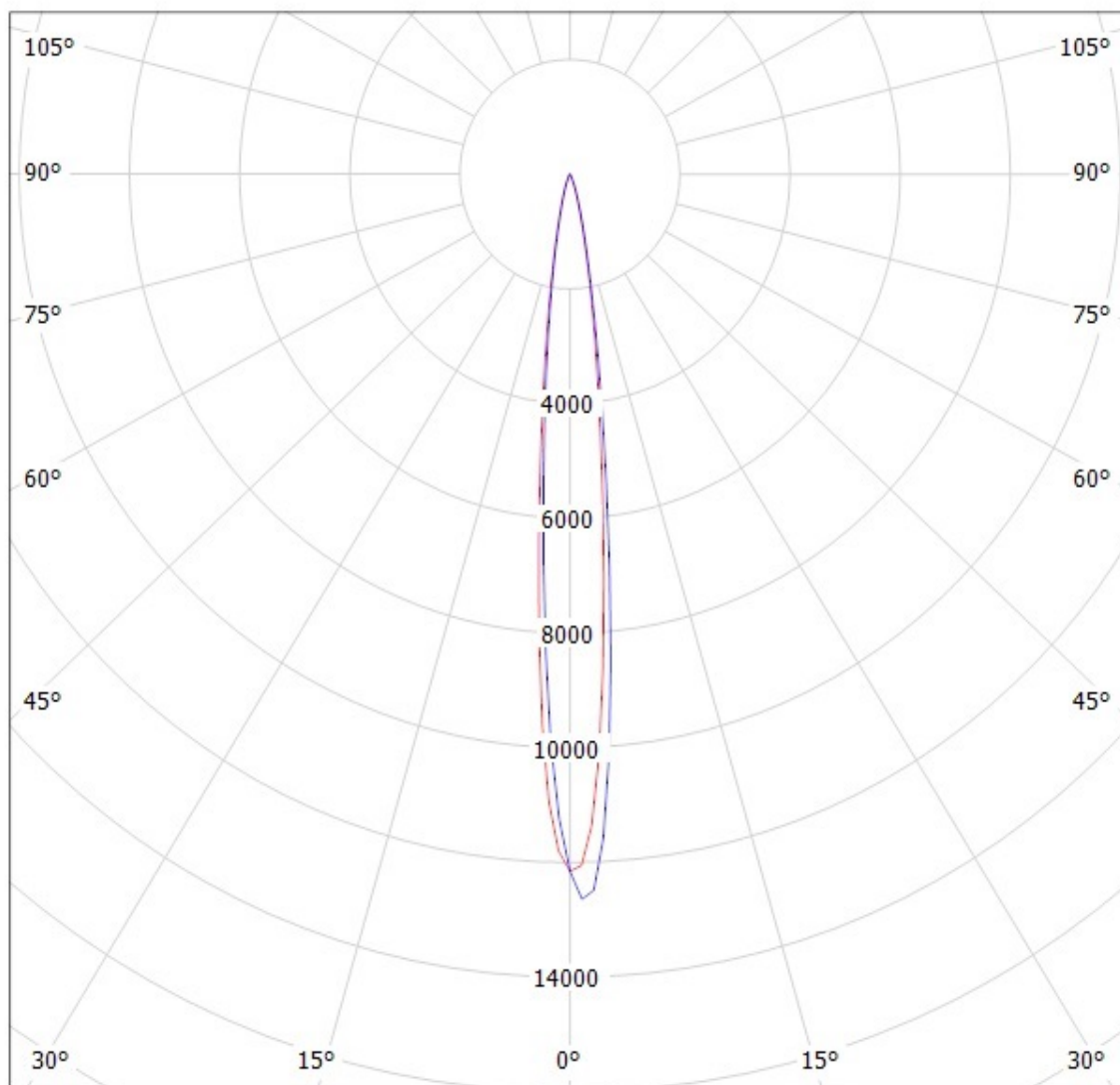

cd/klm

— C0 - C180 — C90 - C270

SIMULATED

Luminaire: LEDil Oy C10754_CUTE3-SS_(XT-E) Efficiency=88%
Lamps: 1 x CRee XT-E (XTEAWT-00-0000-00000HBE8) 218lm @ 250mA CCT=2800K P=2.2W I=250mA

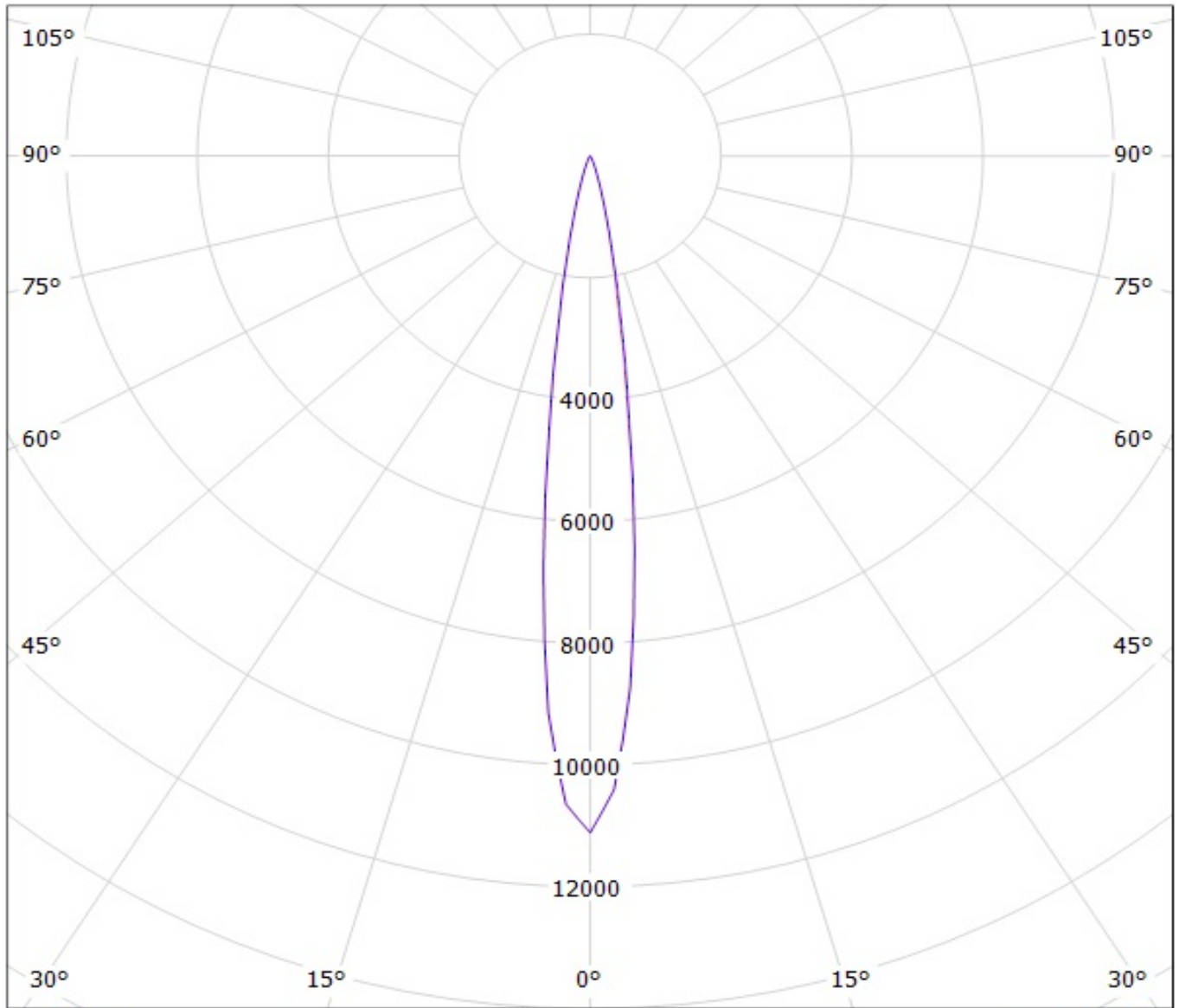

cd/klm

— C0 - C180

— C90 - C270

$\eta = 90\%$

Luminaire: Ledil Oy C10754_CUTE-3-SS (Osram Oslon 150 degree 266Lm @ 250mA)

Lamps: 1 x Osram Oslon 150 degree 266Lm @ 250mA

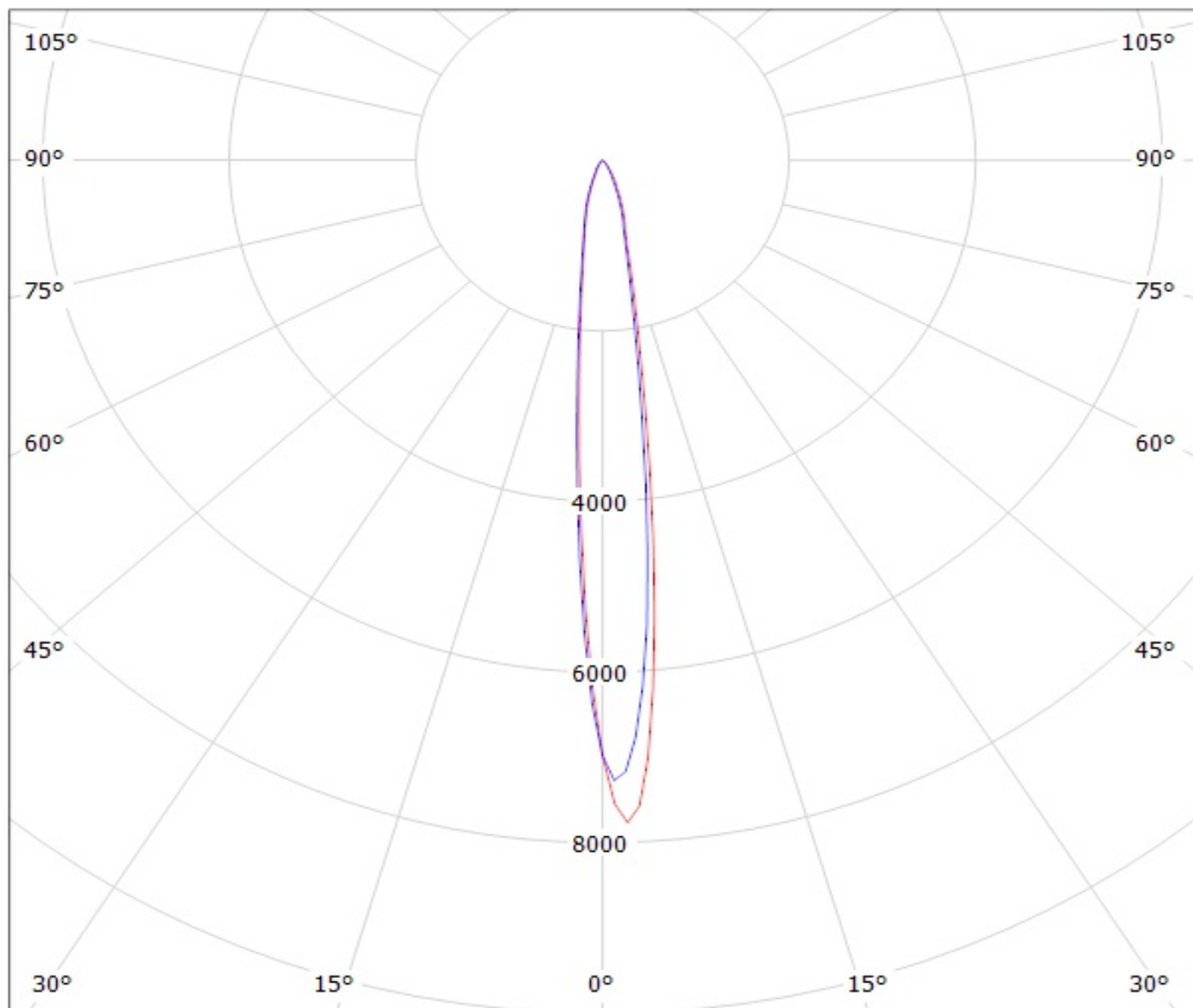

cd/klm

— C0 - C180

— C90 - C270

Luminaire: Ledil Oy C10754_Cute-3-SS_(3535_Ceramic_gen2) Efficiency=86%
Lamps: 1 x Lg 3535 Ceramic gen2 (PKG5700K) 343lm @ 250mA CCT=6100K P=2.2W I=250mA

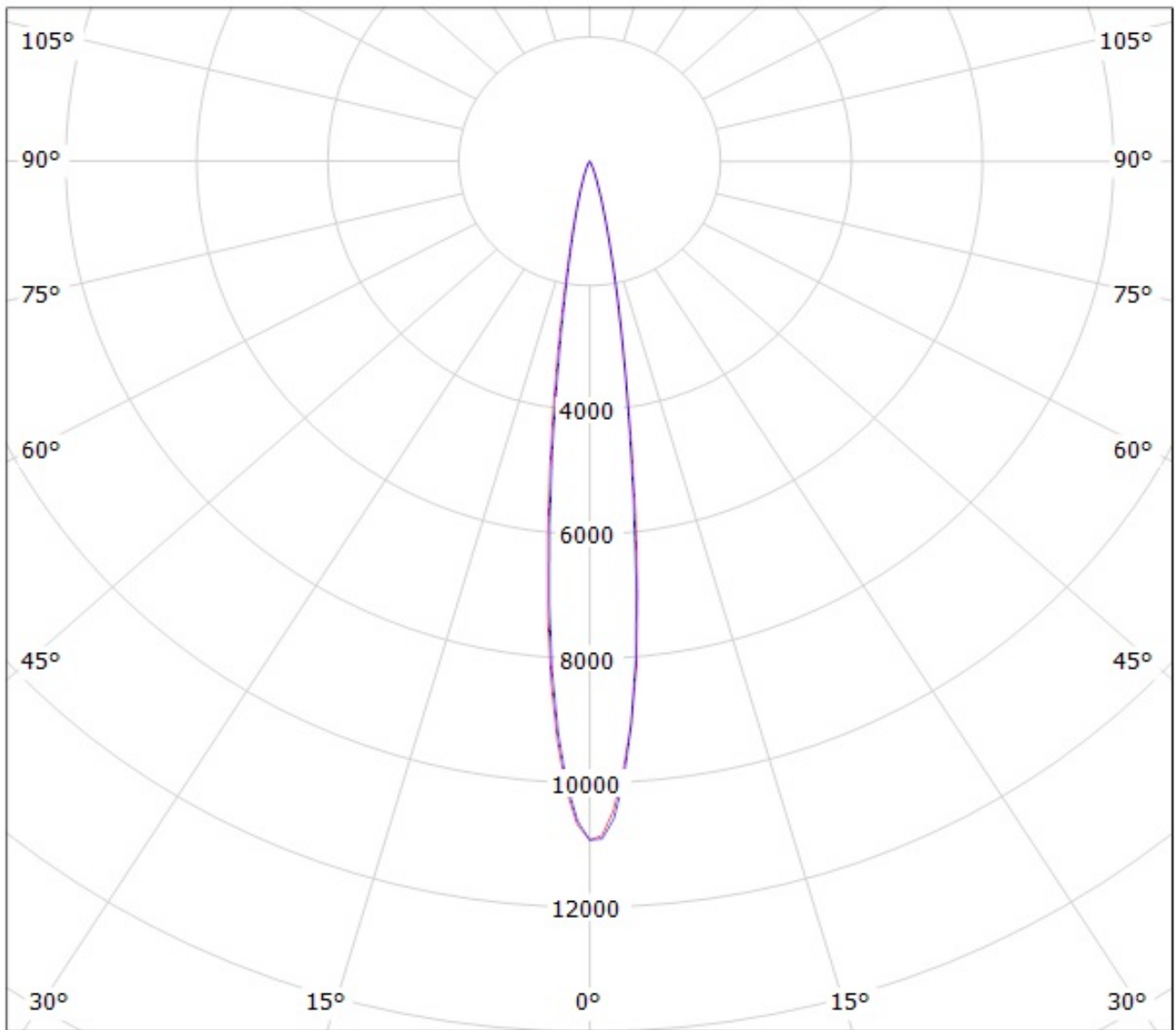

cd/klm

— C0 - C180

— C90 - C270

Luminaire: LEDil Oy C10754_CUTE-3-SS_(Z5M1) Efficiency=88%
Lamps: 1 x Seoul Z5M1 (SZ5-M1-WN-C8) 286lm @ 250mA CCT=4500K P=2.2W I=250mA

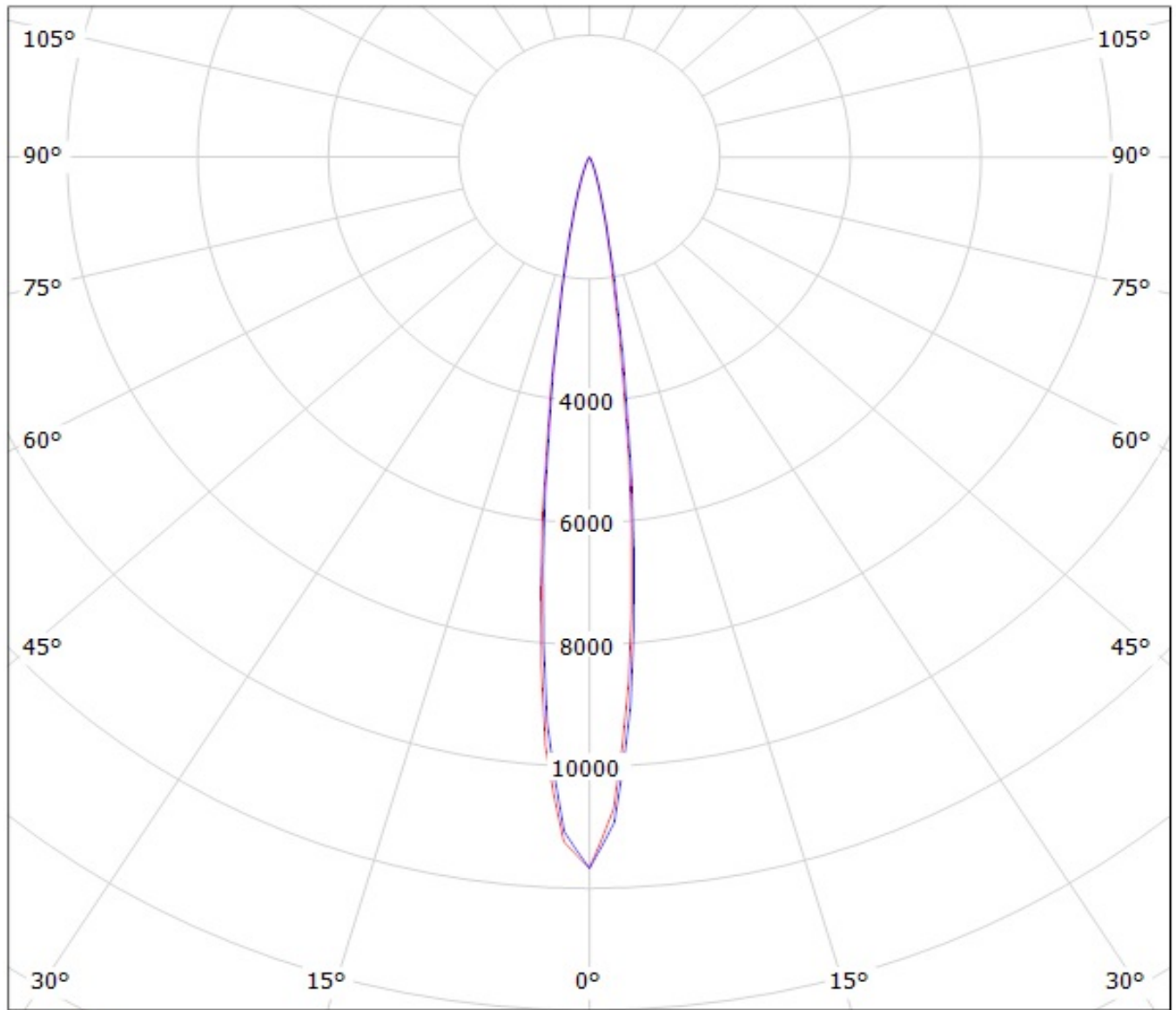

cd/klm

— C0 - C180

— C90 - C270

Ledil Oy C10755_Cute-3-M-XP-G C10755_Cute-3-M-XP-G / LDC (Polar)

Luminaire: Ledil Oy C10755_Cute-3-M-XP-G C10755_Cute-3-M-XP-G

Lamps: 3 x Cree XP-G (White)

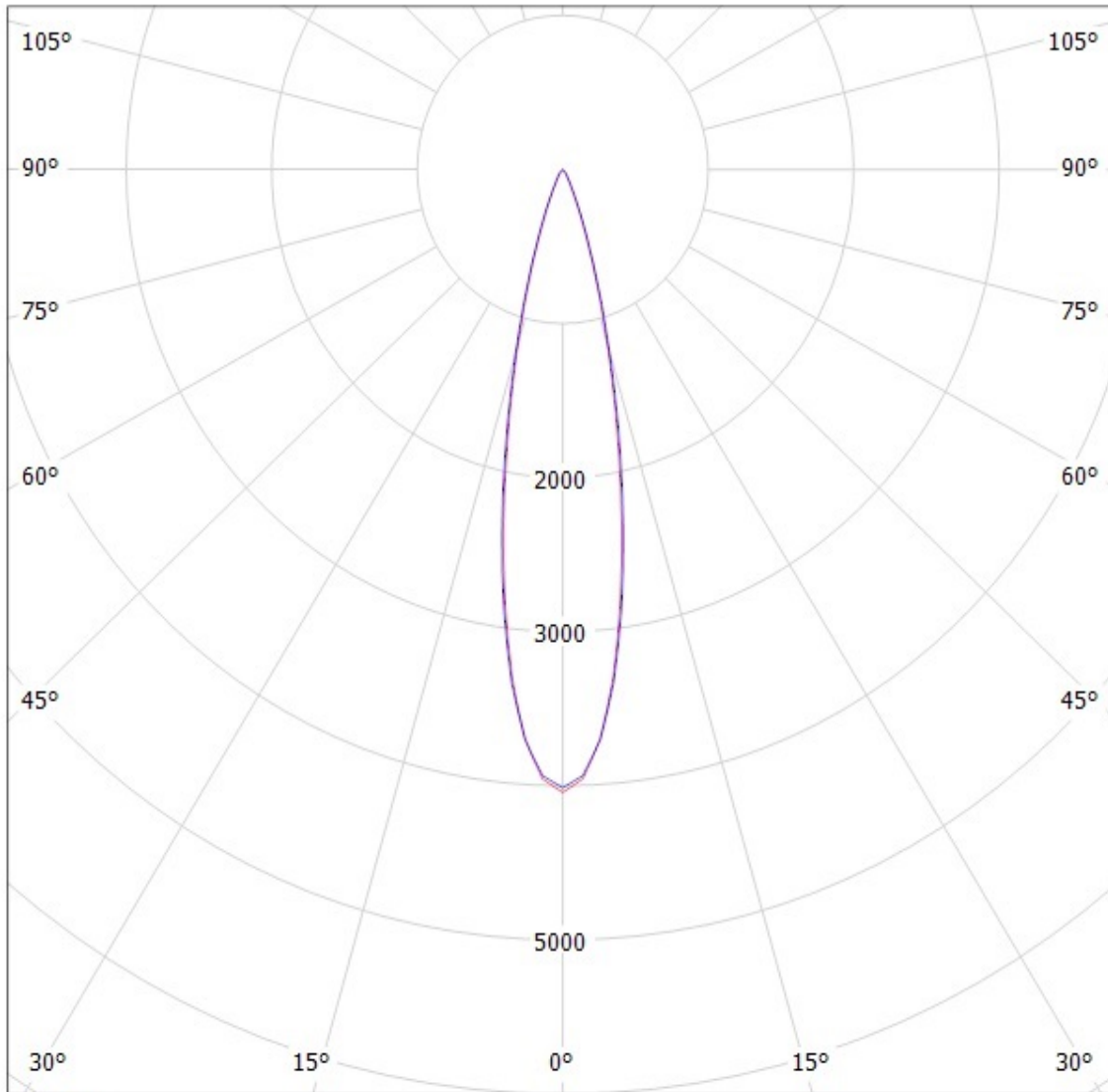

cd/klm

— C0 - C180 — C90 - C270

SIMULATED

Ledil Oy C10755_Cute-3-M-XM C10755_Cute-3-M-XM / LDC (Polar)

Luminaire: Ledil Oy C10755_Cute-3-M-XM C10755_Cute-3-M-XM

Lamps: 1 x Cree XM-L x3

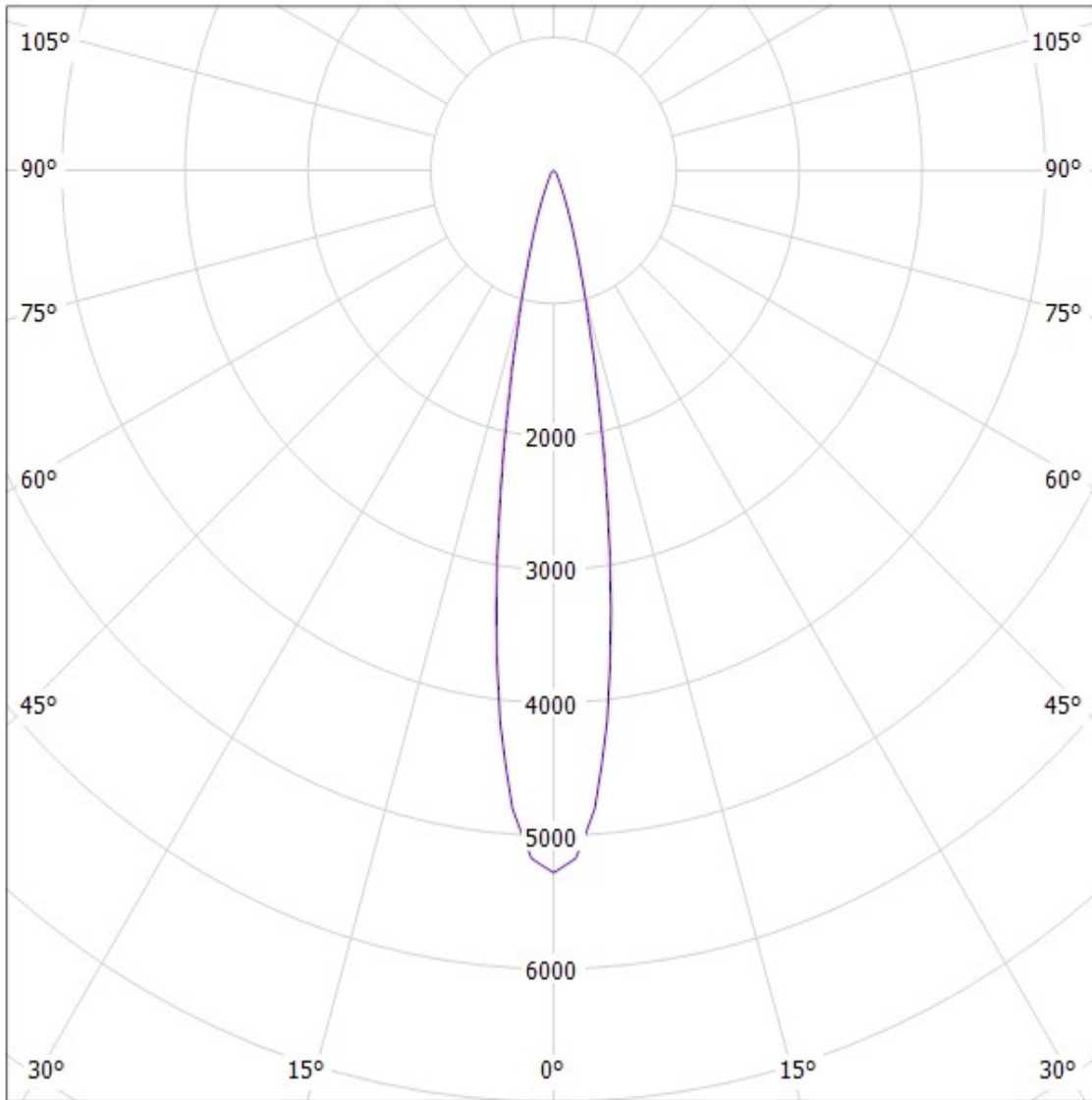

cd/klm

— C0 - C180 — C90 - C270

SIMULATED

Luminaire: LEDil Oy C10754_CUTE-3-SS_(XM-L2) Efficiency=90%
Lamps: 1 x Cree XM-L2 (XMLBWT-0-7B4-T30-0L-0001) 268lm @ 250mA CCT=3200K P=2.1W I=250mA

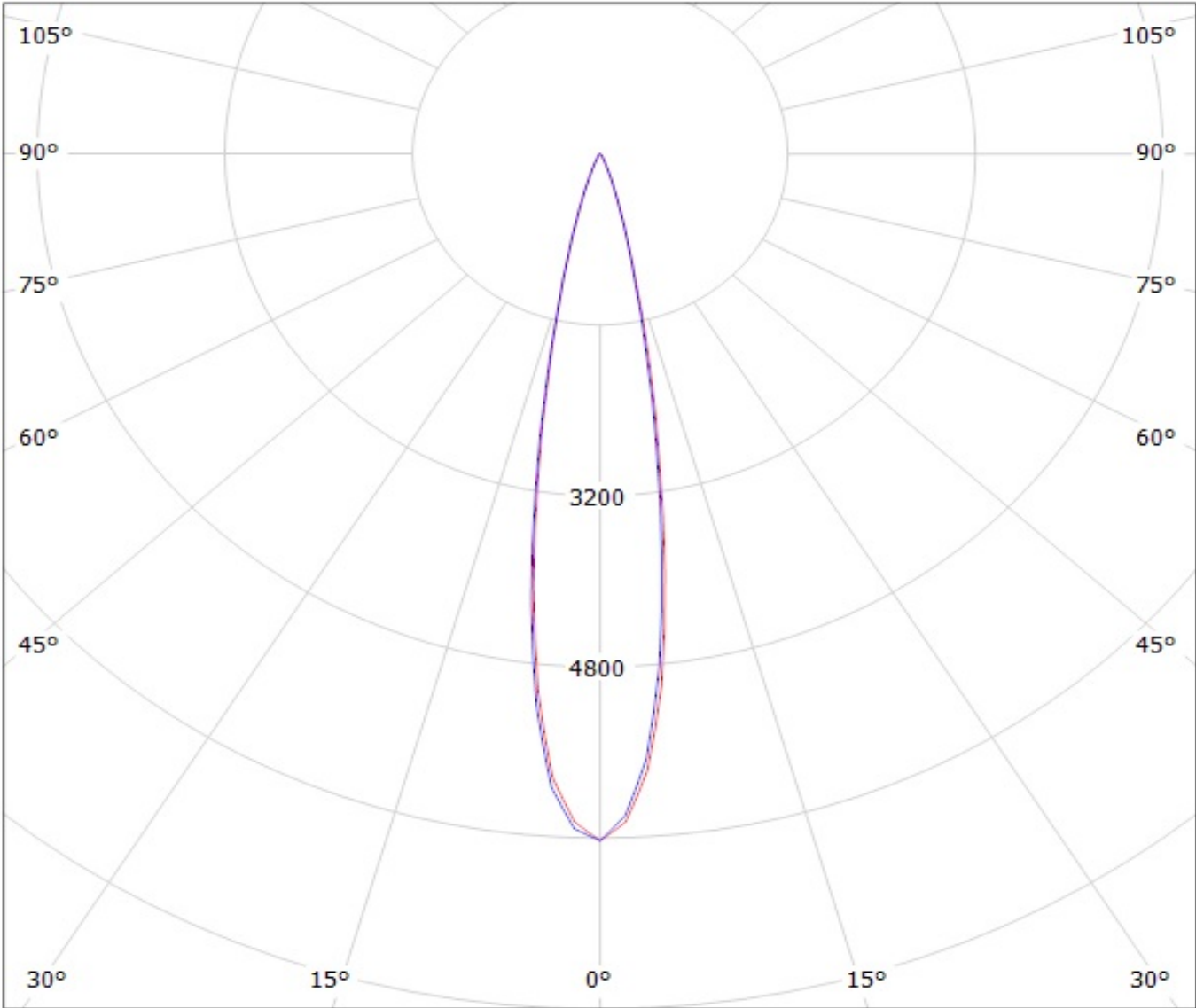

cd/klm

— C0 - C180 — C90 - C270

$\eta = 91\%$

NOTE: The typical divergence will be changed by different color, chip size and chip position tolerance. The typical total divergence is the full angle measured where the luminous intensity is half of the peak value.