



STGP7NC60HD STGF7NC60HD - STGB7NC60HD

N-CHANNEL 14A - 600V - TO-220/TO-220FP/D²PAK
Very Fast PowerMESH™ IGBT

Table 1: General Features

TYPE	V _{CES}	V _{CE(sat)} (Max) @25°C	I _C @100°C
STGP7NC60HD	600 V	< 2.5 V	14 A
STGF7NC60HD	600 V	< 2.5 V	6 A
STGB7NC60HD	600 V	< 2.5 V	14 A

- LOWER ON-VOLTAGE DROP (V_{cesat})
- OFF LOSSES INCLUDE TAIL CURRENT
- LOSSES INCLUDE DIODE RECOVERY ENERGY
- LOWER C_{RES}/C_{IES} RATIO
- HIGH FREQUENCY OPERATION UP TO 70 KHz
- VERY SOFT ULTRA FAST RECOVERY ANTI PARALLEL DIODE
- NEW GENERATION PRODUCTS WITH TIGHTER PARAMETER DISTRIBUTION

DESCRIPTION

Using the latest high voltage technology based on a patented strip layout, STMicroelectronics has designed an advanced family of IGBTs, the PowerMESH™ IGBTs, with outstanding performances. The suffix "H" identifies a family optimized for high frequency applications in order to achieve very high switching performances (reduced t_{fall}) maintaining a low voltage drop.

APPLICATIONS

- HIGH FREQUENCY INVERTERS
- SMPS AND PFC IN BOTH HARD SWITCH AND RESONANT TOPOLOGIES
- MOTOR DRIVERS

Table 2: Order Code

PART NUMBER	MARKING	PACKAGE	PACKAGING
STGP7NC60HD	GP7NC60HD	TO-220	TUBE
STGF7NC60HD	GF7NC60HD	TO-220FP	TUBE
STGB7NC60HDT4	GB7NC60HD	D ² PAK	TAPE & REEL

Figure 1: Package

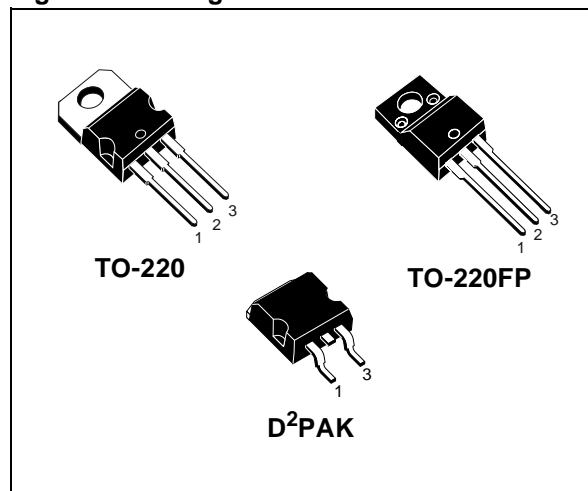

Figure 2: Internal Schematic Diagram

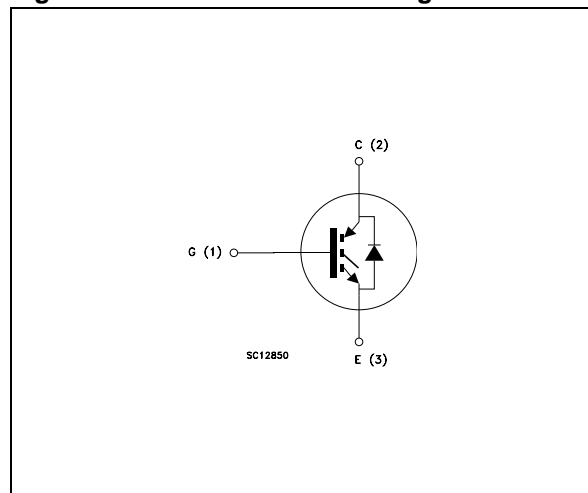

Table 3: Absolute Maximum ratings

Symbol	Parameter	Value		Unit
		STGP7NC60HD STGB7NC60HD	STGF7NC60HD	
V _{CES}	Collector-Emitter Voltage (V _{GS} = 0)	600		V
V _{ECR}	Emitter-Collector Voltage	20		V
V _{GE}	Gate-Emitter Voltage	±20		V
I _C	Collector Current (continuous) at T _C = 25°C (#)	25	10	A
I _C	Collector Current (continuous) at T _C = 100°C (#)	14	6	A
I _{CM} (☐)	Collector Current (pulsed)	50		A
I _F	Diode RMS Forward Current at T _C = 25°C	20		A
P _{TOT}	Total Dissipation at T _C = 25°C	80	25	W
	Derating Factor	0.64	0.20	W/°C
V _{ISO}	Insulation Withstand Voltage A.C.(t = 1 sec; T _c = 25°C)	--	2500	V
T _{stg}	Storage Temperature	- 55 to 150		°C
T _j	Operating Junction Temperature			

(☐) Pulse width limited by max. junction temperature.

Table 4: Thermal Data

			Min.	Typ.	Max.	
R _{thj-case}	Thermal Resistance Junction-case	TO-220 D ² PAK			1.56	°C/W
		TO-220FP			5.0	°C/W
R _{thj-amb}	Thermal Resistance Junction-ambient				62.5	°C/W
T _L	Maximum Lead Temperature for Soldering Purpose (1.6 mm from case, for 10 sec.)			300		°C

ELECTRICAL CHARACTERISTICS (T_{CASE} =25°C UNLESS OTHERWISE SPECIFIED)
Table 5: Main Parameters

Symbol	Parameter	Test Conditions	Min.	Typ.	Max.	Unit
V _{BR(CES)}	Collector-Emitter Breakdown Voltage	I _C = 1 mA, V _{GE} = 0	600			V
I _{CES}	Collector cut-off Current (V _{GE} = 0)	V _{CE} = Max Rating, T _C = 25 °C V _{CE} = Max Rating, T _C = 125 °C			10 1	μA mA
I _{GES}	Gate-Emitter Leakage Current (V _{CE} = 0)	V _{GE} = ± 20V, V _{CE} = 0			±100	nA
V _{GE(th)}	Gate Threshold Voltage	V _{CE} = V _{GE} , I _C = 250 μA	3.75		5.75	V
V _{CE(sat)}	Collector-Emitter Saturation Voltage	V _{GE} = 15V, I _C = 7 A		1.85	2.5	V
		V _{GE} = 15V, I _C = 7 A, T _C = 125°C		1.7		V

(#) Calculated according to the iterative formula:

$$I_C(T_C) = \frac{T_{JMAX} - T_C}{R_{THJ-C} \times V_{CESAT(MAX)}(T_C, I_C)}$$

ELECTRICAL CHARACTERISTICS (CONTINUED)

Table 6: Dynamic

Symbol	Parameter	Test Conditions	Min.	Typ.	Max.	Unit
g_{fs} (1)	Forward Transconductance	$V_{CE} = 15\text{ V}$, $I_C = 7\text{ A}$		4.30		S
C_{ies}	Input Capacitance	$V_{CE} = 25\text{ V}$, $f = 1\text{ MHz}$, $V_{GE} = 0$		720		pF
C_{oes}	Output Capacitance			81		pF
C_{res}	Reverse Transfer Capacitance			17		pF
Q_g Q_{ge} Q_{gc}	Total Gate Charge Gate-Emitter Charge Gate-Collector Charge	$V_{CE} = 390\text{ V}$, $I_C = 7\text{ A}$, $V_{GE} = 15\text{ V}$ (see Figure 22)		35 7 16	48	nC nC nC
I_{CL}	Turn-Off SOA Minimum Current	$V_{clamp} = 480\text{ V}$, $T_j = 150^\circ\text{C}$ $R_G = 10\ \Omega$, $V_{GE} = 15\text{ V}$	50			A

(1) Pulsed: Pulse duration= 300 μs , duty cycle 1.5%

Table 7: Switching On

Symbol	Parameter	Test Conditions	Min.	Typ.	Max.	Unit
$t_{d(on)}$ t_r $(di/dt)_{on}$	Turn-on Delay Time Current Rise Time Turn-on Current Slope	$V_{CC} = 390\text{ V}$, $I_C = 7\text{ A}$ $R_G = 10\ \Omega$, $V_{GE} = 15\text{ V}$, $T_j = 25^\circ\text{C}$ (see Figure 19)		18.5 8.5 1060		ns ns A/ μs
$t_{d(on)}$ t_r $(di/dt)_{on}$	Turn-on Delay Time Current Rise Time Turn-on Current Slope	$V_{CC} = 390\text{ V}$, $I_C = 7\text{ A}$ $R_G = 10\ \Omega$, $V_{GE} = 15\text{ V}$, $T_j = 125^\circ\text{C}$ (see Figure 20)		18.5 7 1000		ns ns A/ μs

Table 8: Switching Off

Symbol	Parameter	Test Conditions	Min.	Typ.	Max.	Unit	
$t_r(V_{off})$ $t_{d(off)}$ t_f	Off Voltage Rise Time Turn-off Delay Time Current Fall Time	$V_{CC} = 390\text{ V}$, $I_C = 7\text{ A}$, $R_G = 10\ \Omega$, $V_{GE} = 15\text{ V}$ $T_j = 25^\circ\text{C}$ (see Figure 20)		27 72 60		ns ns ns	
$t_r(V_{off})$ $t_{d(off)}$ t_f	Off Voltage Rise Time Turn-off Delay Time Current Fall Time		$V_{CC} = 390\text{ V}$, $I_C = 7\text{ A}$, $R_G = 10\ \Omega$, $V_{GE} = 15\text{ V}$ $T_j = 125^\circ\text{C}$ (see Figure 20)		56 116 105		ns ns ns

Table 9: Switching Energy

Symbol	Parameter	Test Conditions	Min.	Typ.	Max.	Unit	
E_{on} (2) E_{off} (3) E_{ts}	Turn-on Switching Losses Turn-off Switching Loss Total Switching Loss	$V_{CC} = 390\text{ V}$, $I_C = 7\text{ A}$ $R_G = 10\ \Omega$, $V_{GE} = 15\text{ V}$, $T_j = 25^\circ\text{C}$ (see Figure 19)		95 115 210	125 150 275	μJ μJ μJ	
E_{on} (2) E_{off} (3) E_{ts}	Turn-on Switching Losses Turn-off Switching Loss Total Switching Loss		$V_{CC} = 390\text{ V}$, $I_C = 7\text{ A}$ $R_G = 10\ \Omega$, $V_{GE} = 15\text{ V}$, $T_j = 125^\circ\text{C}$ (see Figure 20)		140 215 355		μJ μJ μJ

(2) E_{on} is the turn-on losses when a typical diode is used in the test circuit in figure 2. If the IGBT is offered in a package with a co-pack diode, the co-pack diode is used as external diode. IGBTs & DIODE are at the same temperature (25°C and 125°C)

(3) Turn-off losses include also the tail of the collector current.

Table 10: Collector-Emitter Diode

Symbol	Parameter	Test Condition	Min.	Typ.	Max.	Unit	
V_f	Forward On-Voltage	$I_f = 3.5 \text{ A}$		1.3	1.9	V	
		$I_f = 3.5 \text{ A}, T_j = 125 \text{ }^\circ\text{C}$		1.1		V	
t_{rr}	Reverse Recovery Time	$I_f = 7 \text{ A}, V_R = 40 \text{ V},$ $T_j = 25 \text{ }^\circ\text{C}, di/dt = 100 \text{ A}/\mu\text{s}$		37		ns	
t_a	Reverse Recovery Charge			22		ns	
Q_{rr}				40		nC	
I_{rrm}			Reverse Recovery Current		2.1		A
S			Softness factor of the diode		0.68		
t_{rr}	Reverse Recovery Time	$I_f = 7 \text{ A}, V_R = 40 \text{ V},$ $T_j = 125 \text{ }^\circ\text{C}, di/dt = 100 \text{ A}/\mu\text{s}$		61		ns	
t_a	Reverse Recovery Charge			34		ns	
Q_{rr}				98		nC	
I_{rrm}			Reverse Recovery Current		3.2		A
S			Softness factor of the diode		0.79		

Figure 3: Output Characteristics

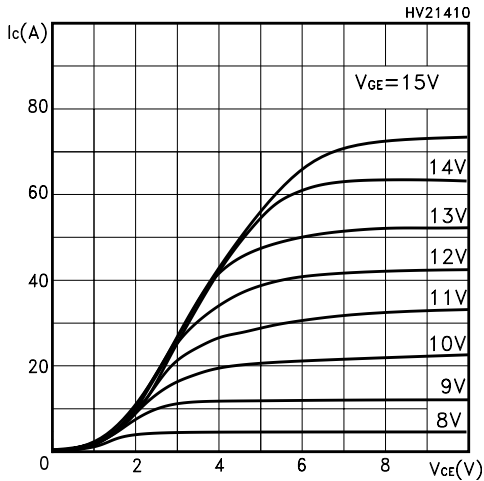

Figure 4: Transconductance

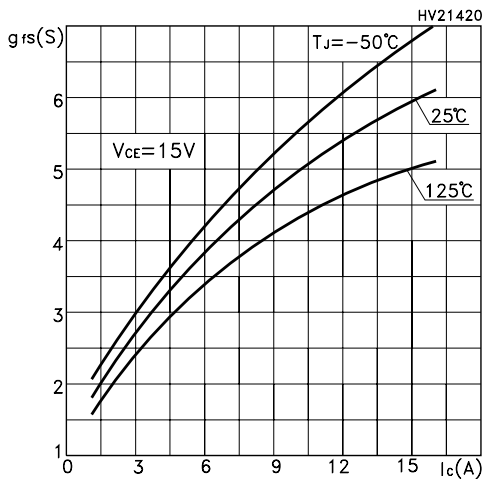

Figure 5: Collector-Emitter On Voltage vs Collector Current

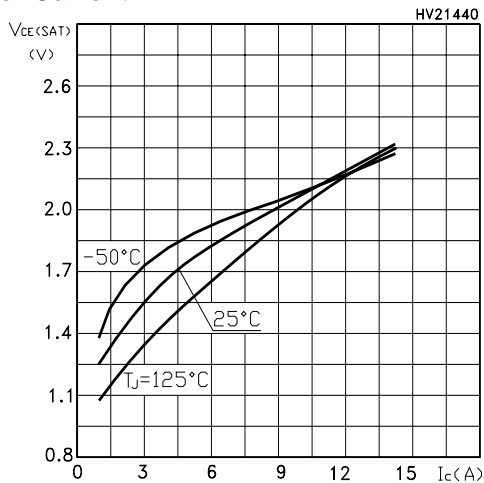

Figure 6: Transfer Characteristics

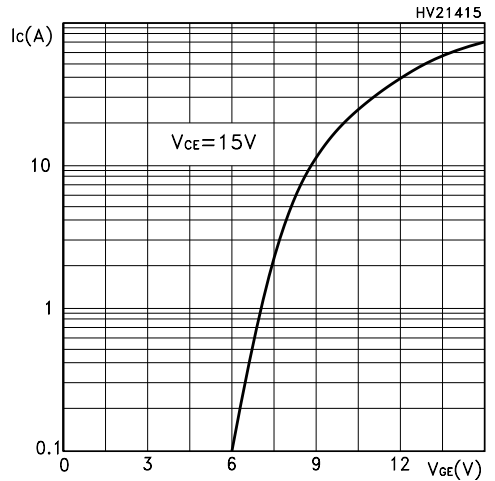

Figure 7: Collector-Emitter On Voltage vs Temperature

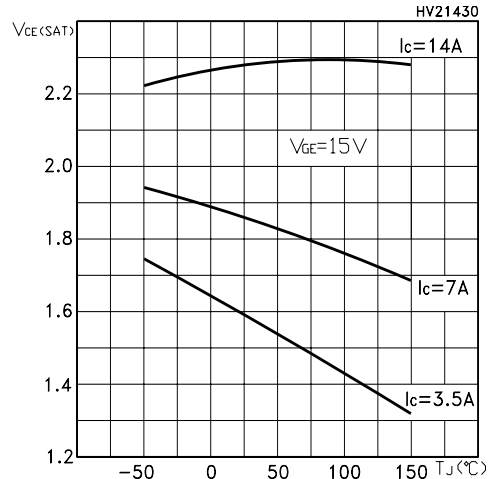

Figure 8: Normalized Gate Threshold vs Temperature

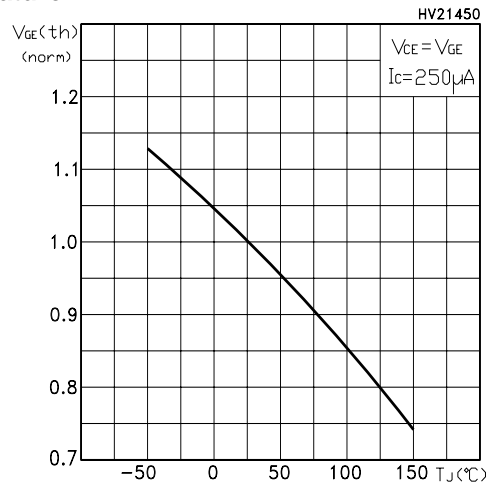

Figure 9: Normalized Breakdown Voltage vs Temperature

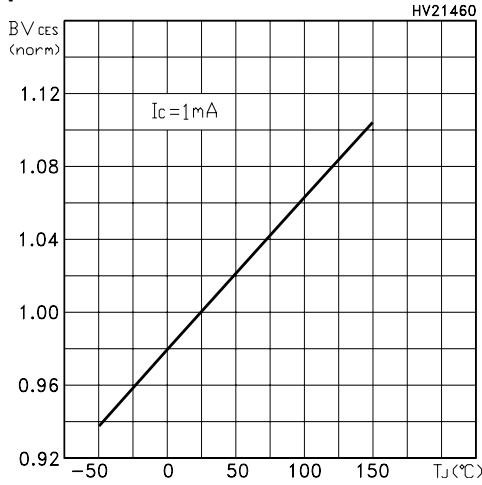

Figure 10: Capacitance Variations

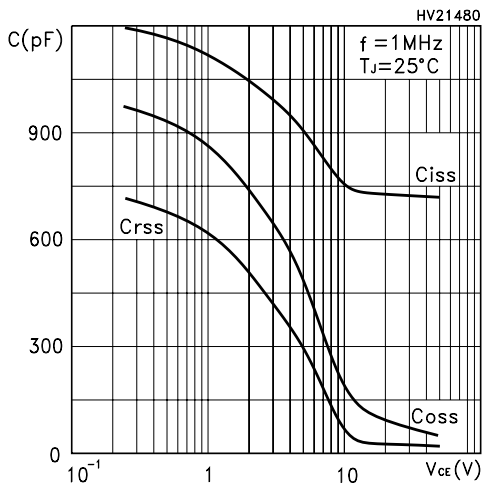

Figure 11: Total Switching Losses vs Gate Resistance

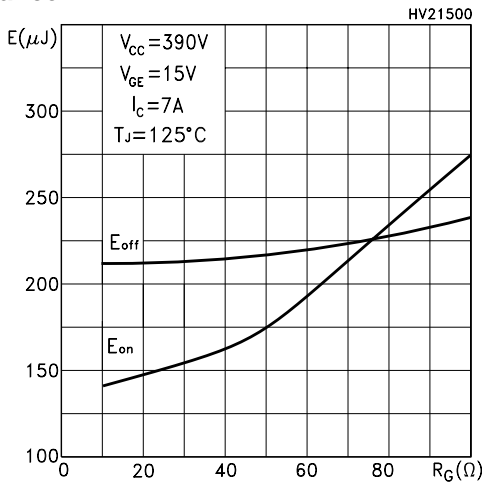

Figure 12: Gate Charge vs Gate-Emitter Voltage

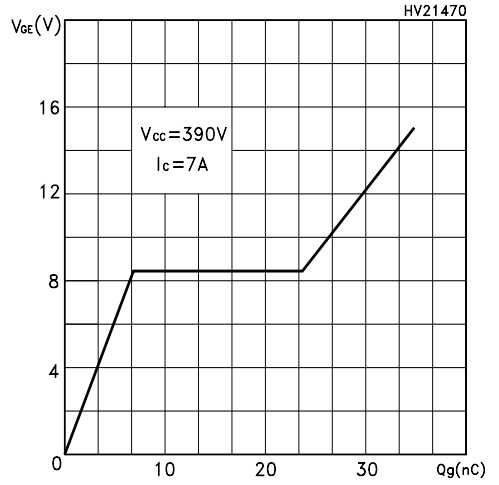

Figure 13: Total Switching Losses vs Temperature

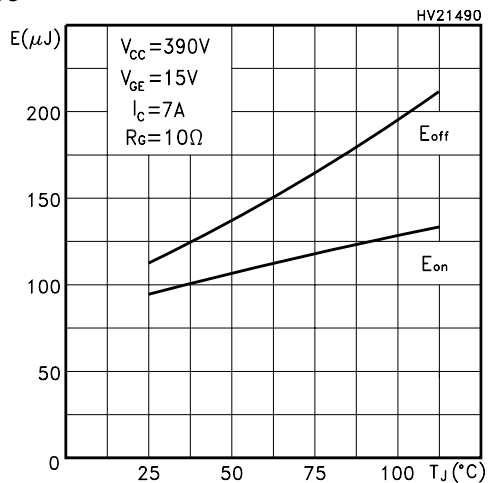

Figure 14: Total Switching Losses vs Collector Current

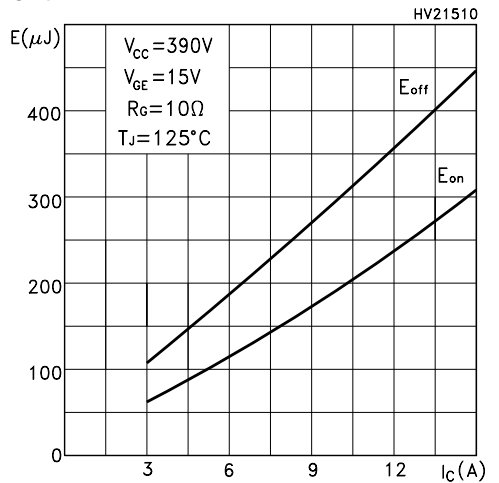

Figure 15: Thermal Impedance For TO-220/ D²PAK

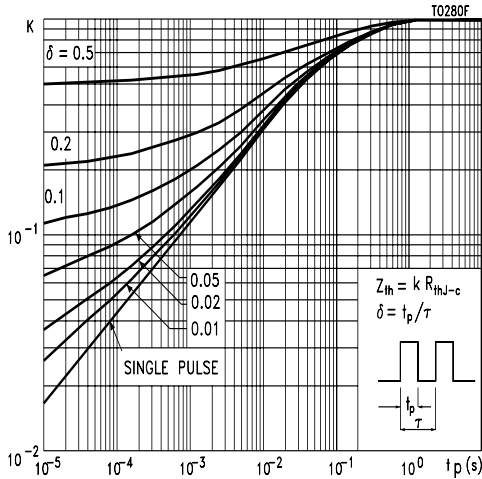

Figure 16: Thermal Impedance For TO-220FP

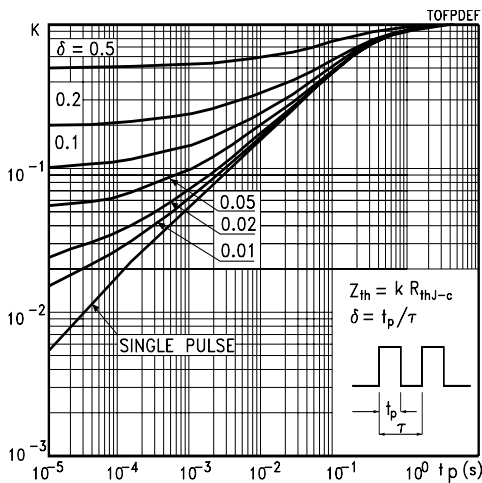

Figure 17: Turn-Off SOA

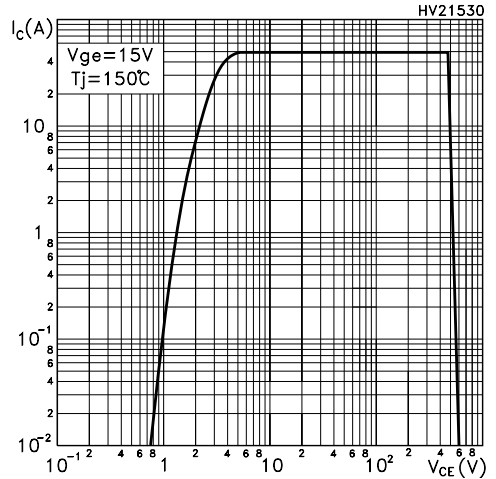

Figure 18: Emitter-Collector Diode Characteristics

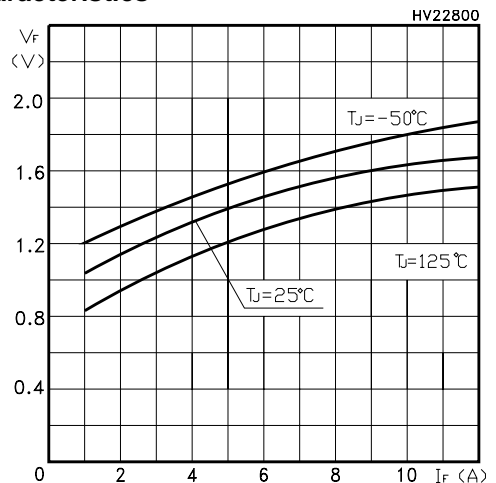
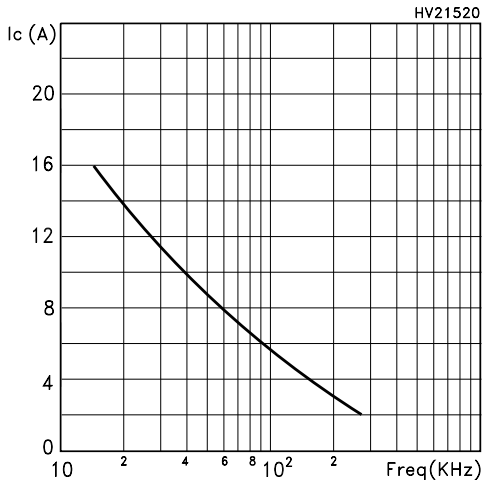

Figure 19: Ic vs Frequency



For a fast IGBT suitable for high frequency applications, the typical collector current vs. maximum operating frequency curve is reported. That frequency is defined as follows:

$$f_{MAX} = (P_D - P_C) / (E_{ON} + E_{OFF})$$

1) The maximum power dissipation is limited by maximum junction to case thermal resistance:

$$P_D = \Delta T / R_{THJ-C}$$

considering $\Delta T = T_J - T_C = 125\text{ }^\circ\text{C} - 75\text{ }^\circ\text{C} = 50\text{ }^\circ\text{C}$

2) The conduction losses are:

$$P_C = I_C * V_{CE(SAT)} * \delta$$

with 50% of duty cycle, V_{CESAT} typical value @ 125°C.

3) Power dissipation during ON & OFF commutations is due to the switching frequency:

$$P_{SW} = (E_{ON} + E_{OFF}) * \text{freq.}$$

4) Typical values @ 125°C for switching losses are used (test conditions: $V_{CE} = 390\text{V}$, $V_{GE} = 15\text{V}$, $R_G = 3.3\text{ Ohm}$). Furthermore, diode recovery energy is included in the E_{ON} (see note 2), while the tail of the collector current is included in the E_{OFF} measurements (see note 3).

Figure 20: Test Circuit for Inductive Load Switching

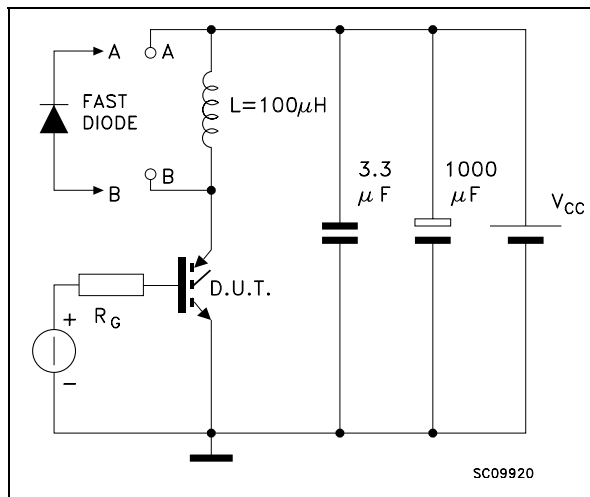

Figure 21: Switching Waveforms

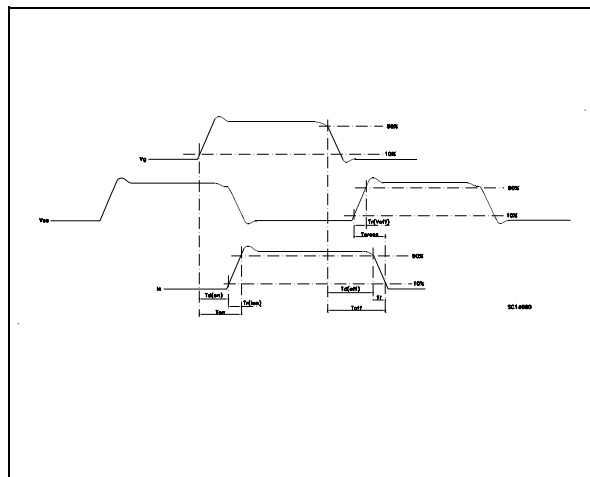

Figure 22: Gate Charge Test Circuit

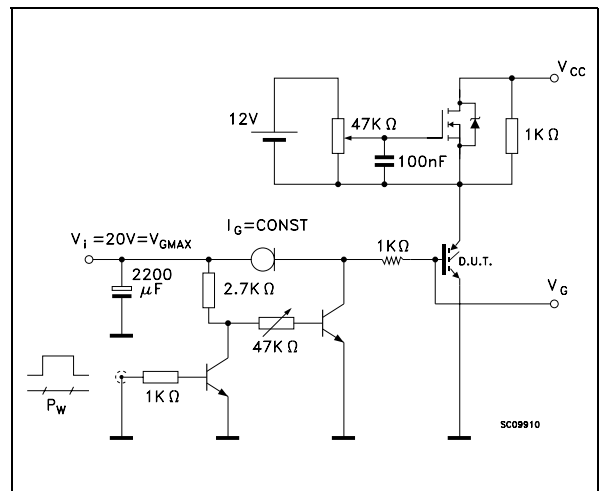
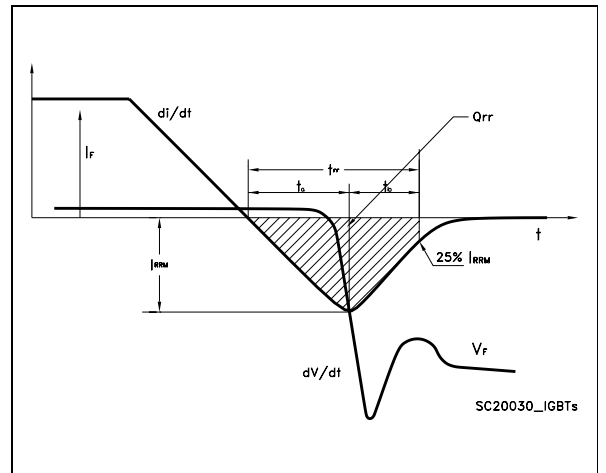
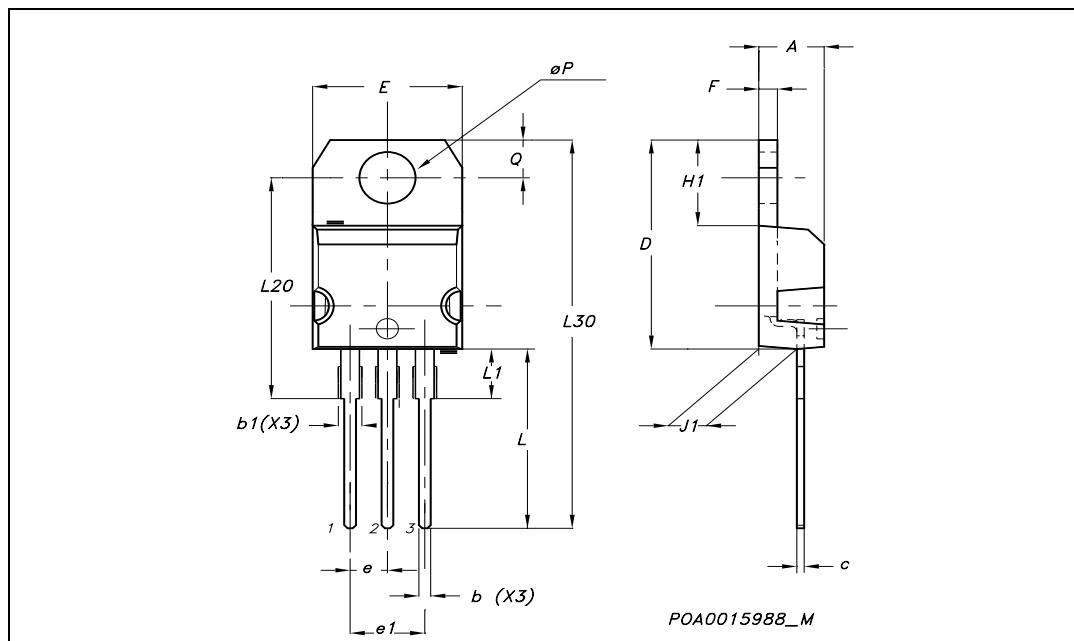

Figure 23: Diode Recovery Time Waveforms



TO-220 MECHANICAL DATA

DIM.	mm.			inch		
	MIN.	TYP	MAX.	MIN.	TYP.	MAX.
A	4.40		4.60	0.173		0.181
b	0.61		0.88	0.024		0.034
b1	1.15		1.70	0.045		0.066
c	0.49		0.70	0.019		0.027
D	15.25		15.75	0.60		0.620
E	10		10.40	0.393		0.409
e	2.40		2.70	0.094		0.106
e1	4.95		5.15	0.194		0.202
F	1.23		1.32	0.048		0.052
H1	6.20		6.60	0.244		0.256
J1	2.40		2.72	0.094		0.107
L	13		14	0.511		0.551
L1	3.50		3.93	0.137		0.154
L20		16.40			0.645	
L30		28.90			1.137	
øP	3.75		3.85	0.147		0.151
Q	2.65		2.95	0.104		0.116



TO-220FP MECHANICAL DATA

DIM.	mm.			inch		
	MIN.	TYP	MAX.	MIN.	TYP.	MAX.
A	4.4		4.6	0.173		0.181
B	2.5		2.7	0.098		0.106
D	2.5		2.75	0.098		0.108
E	0.45		0.7	0.017		0.027
F	0.75		1	0.030		0.039
F1	1.15		1.7	0.045		0.067
F2	1.15		1.7	0.045		0.067
G	4.95		5.2	0.195		0.204
G1	2.4		2.7	0.094		0.106
H	10		10.4	0.393		0.409
L2		16			0.630	
L3	28.6		30.6	1.126		1.204
L4	9.8		10.6	.0385		0.417
L5	2.9		3.6	0.114		0.141
L6	15.9		16.4	0.626		0.645
L7	9		9.3	0.354		0.366
∅	3		3.2	0.118		0.126

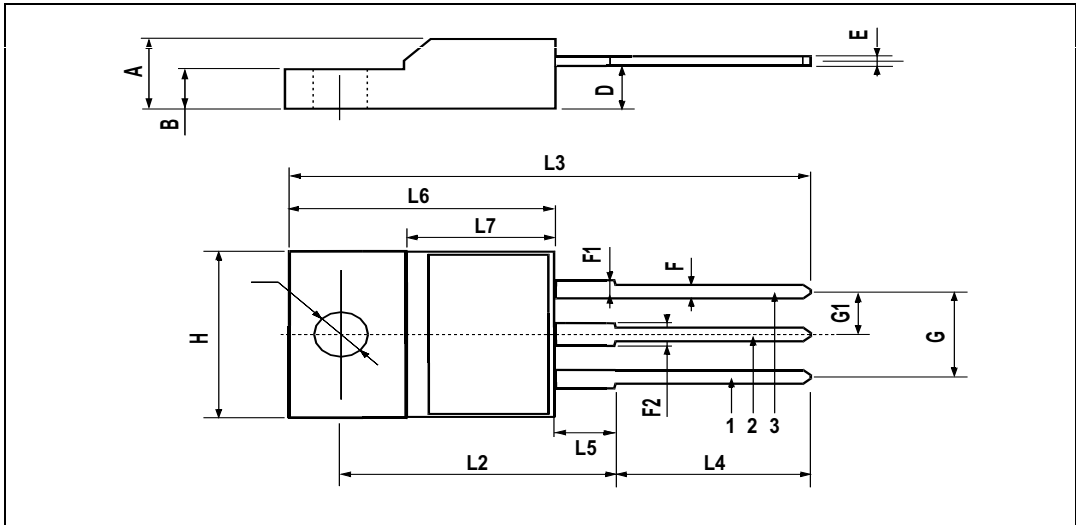

TO-263 (D²PAK) MECHANICAL DATA

DIM.	mm.			inch		
	MIN.	TYP	MAX.	MIN.	TYP.	MAX.
A	4.32		4.57	0.178		0.180
A1	0.00		0.25	0.00		0.009
b	0.71		0.91	0.028		0.350
b2	1.15		1.40	0.045		0.055
c	0.46		0.61	0.018		0.024
c2	1.22		1.40	0.048		0.055
D	8.89	9.02	9.40	0.350	0.355	0.370
D1	8.01			0.315		
E	10.04		10.28	0.395		0.404
e		2.54			0.010	
H	13.10		13.70	0.515		0.540
L	1.30		1.70	0.051		0.067
L1	1.15		1.39	0.045		0.054
L2	1.27		1.77	0.050		0.069
L4	2.70		3.10	0.106		0.122
V2	0°		8°	0°		8°

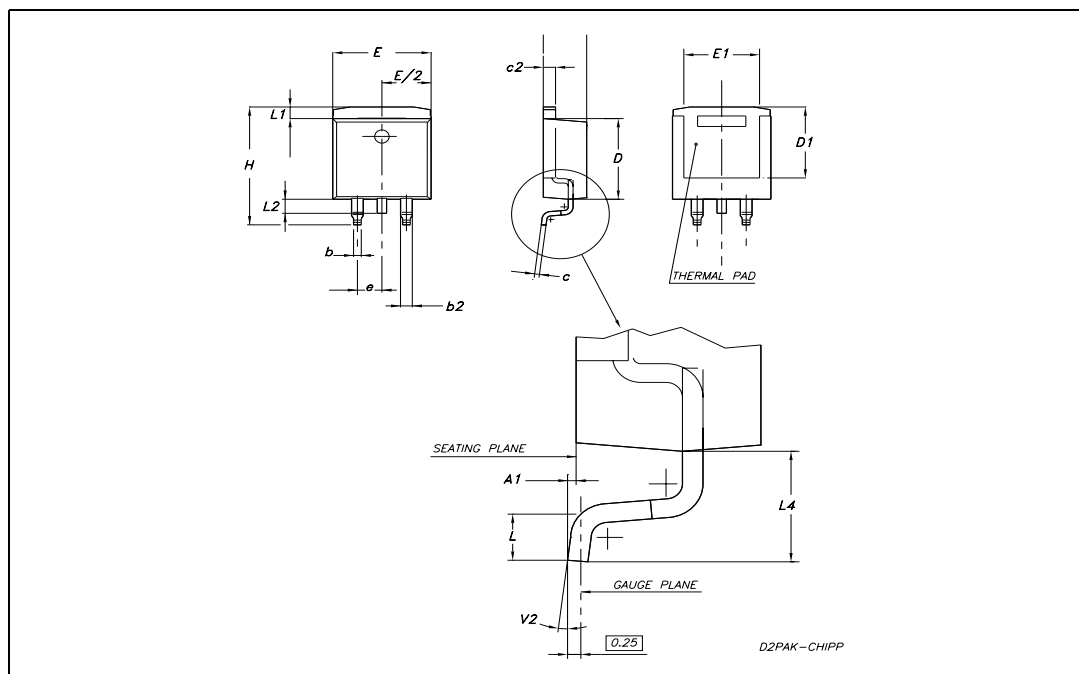

D²PAK FOOTPRINT

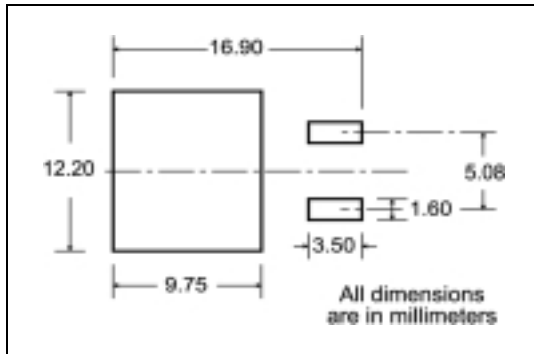

TAPE AND REEL SHIPMENT

TAPE MECHANICAL DATA

DIM.	mm		inch	
	MIN.	MAX.	MIN.	MAX.
A0	10.5	10.7	0.413	0.421
B0	15.7	15.9	0.618	0.626
D	1.5	1.6	0.059	0.063
D1	1.59	1.61	0.062	0.063
E	1.65	1.85	0.065	0.073
F	11.4	11.6	0.449	0.456
K0	4.8	5.0	0.189	0.197
P0	3.9	4.1	0.153	0.161
P1	11.9	12.1	0.468	0.476
P2	1.9	2.1	0.075	0.082
R	50		1.574	
T	0.25	0.35	0.0098	0.0137
W	23.7	24.3	0.933	0.956

REEL MECHANICAL DATA

DIM.	mm		inch	
	MIN.	MAX.	MIN.	MAX.
A		330		12.992
B	1.5		0.059	
C	12.8	13.2	0.504	0.520
D	20.2		0.795	
G	24.4	26.4	0.960	1.039
N	100		3.937	
T		30.4		1.197

BASE QTY	BULK QTY
1000	1000

* on sales type

Table 11: Revision History 9

Date	Revision	Description of Changes
07-Jun-2004	4	Stylesheet update. No content change
19-Aug-2004	5	Complete Version
17-Sep-2004	6	Figure 18 has been added
09-Nov-2004	7	Final datasheet
19-Jan-2005	8	Datasheet updated
09-Jun-2005	9	Modified title

Information furnished is believed to be accurate and reliable. However, STMicroelectronics assumes no responsibility for the consequences of use of such information nor for any infringement of patents or other rights of third parties which may result from its use. No license is granted by implication or otherwise under any patent or patent rights of STMicroelectronics. Specifications mentioned in this publication are subject to change without notice. This publication supersedes and replaces all information previously supplied. STMicroelectronics products are not authorized for use as critical components in life support devices or systems without express written approval of STMicroelectronics.

The ST logo is a registered trademark of STMicroelectronics

All other names are the property of their respective owners

© 2005 STMicroelectronics - All Rights Reserved

STMicroelectronics group of companies

Australia - Belgium - Brazil - Canada - China - Czech Republic - Finland - France - Germany - Hong Kong - India - Israel - Italy - Japan - Malaysia - Malta - Morocco - Singapore - Spain - Sweden - Switzerland - United Kingdom - United States of America