

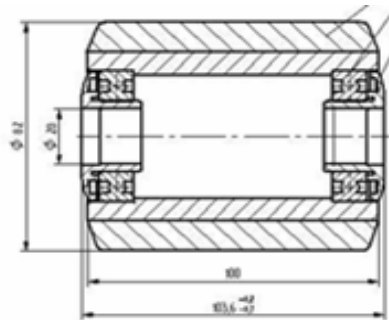

Data-sheet ETX Type F

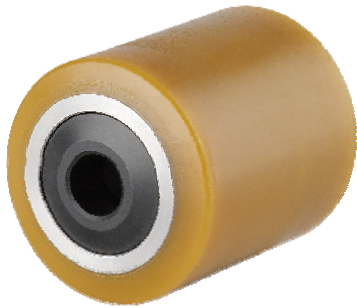

ETX085x95-Ø20 NL100-Type F

EAN4031582339598

Wheel centre made of steel, tread made of Polyurethane, casted, precision ball bearing, sealed

Wheel diameter: 85 mm

Width of Tread: 95 mm

Axle Hole Ø: 20 mm

Hub length: 100 mm

Temperature: - 20 / + 60 °C

Hardness of tread: Shore A 92

Dynamic Load capacity: 900 kg