

Datasheet

6.35 x 31.75mm F Cartridge Fuse, 4A, 250 V

RS Stock 611-9059



Dimensions: (mm)

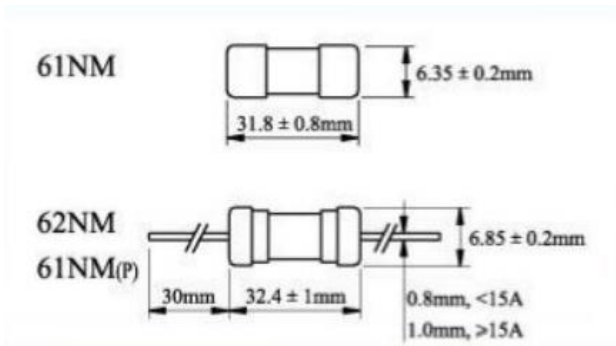

Specifications:

Interrupting Rating

- 10,000 amperes at 125V AC (32mA-10A)
- 35 amperes at 250V AC (32mA-1A)
- 100 amperes at 250V AC (1.2-3.5a)
- 200 amperes 250V AC (4A-10A)
- 500 amperes 125V AC (1A-15A) PSE
- 100 amperes at 250 V AC (100mA-15A) PSE,KTL

Electrical Characteristics

Rating	Blowing Time
100%	4 hours Min
135%	1 hour Max
200%	5 sec Max

61NM/62NM RoHS I-T CHARACTERISTICS CURVE

