



ENGLISH

Datasheet

RS Pro Prominent Indicator Panel Mount, 14mm Mounting Hole Size, Red LED, Solder Tab Termination, 10 mm Lamp Size, 24 V dc

RS Stock No: **210-866**





ENGLISH

TECHNICAL SPECIFICATIONS		
Voltage	Operating Voltage (Min to Max)	Operating Current (Typical All Types)
02 (No Resistor)	1.8 to 3.3VDC	20mA max*
6VDC	5.4 to 6.6VDC	20mA
12VDC	10.8 to 13.2VDC	20mA
24VDC	21.6 to 26.4VDC	20mA
28VDC	25.2 to 30.8VDC	20mA
110VAC	99 to 121VAC	6mA
220VAC	207 to 253VAC	3mA

Max Reverse Voltage: 5V
Viewing Angle: 30–100° (dependant on model)
Life Expectancy: 100,000 hours
Temperature Range: –40 to +85°C (operating & storage)
Torque: 75cNm

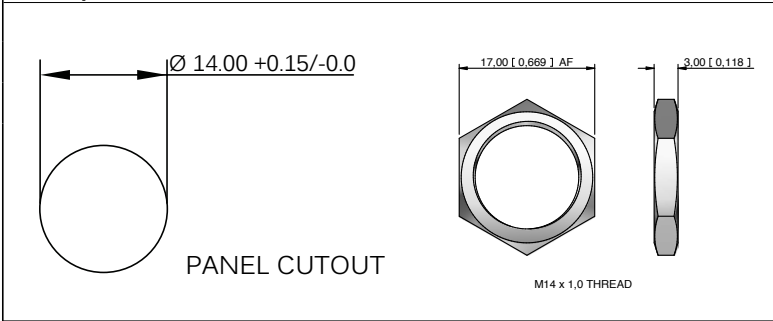

Standard LED Intensity	Prominent and Recessed	Flush	Forward Voltage
HE Red	80mcd	10mcd	2.0V
Green	60mcd	5mcd	2.2V
Yellow	50mcd	4mcd	2.1V
Blue	540mcd	100mcd	3.3V
White	1000mcd	150mcd	3.3V
Orange	80mcd	200mcd	2.0V
Bi-color (Typical) (Red/Green)	15/15mcd	14/10mcd	2.0V/2.2V
Tri-color (Typical) (Red/Green/Yellow)	60/50/50mcd	15/10/30mcd	2.0V/2.2V/2.1V

Bi-color - The color is changed by reversing the polarity of the supply voltage.
 Tri-color - The indicator has red and green LEDs, when both connected yellow is produced.

Super Bright LED	Prominent and Recessed	Flush	Forward Voltage
HE Red	17,000mcd	2,000mcd	2.2V
Green	11,000mcd	680mcd	3.5V
Yellow	4,000mcd	350mcd	2.3V
Blue	2,500mcd	250mcd	3.3V
White	4,400mcd	250mcd	3.3V
Orange	2800mcd	300mcd	2.1V

Hyper Bright LED	Prominent and Recessed	Flush	Forward Voltage
HE Red	2,800mcd	800mcd	2.1V
Green	2,200mcd	250mcd	3.2V
Yellow	1,300mcd	250mcd	2.0V
Orange	850mcd	200mcd	2.1V

Luminous intensity will be reduced with lower operating current.

Note: The operating voltage must not be exceeded by more than 10% as this will result in reduced life expectancy.
 The company reserves the right to change specifications without notice.
 * Customer to supply resistor for desired operating current.
 Luminous intensity is measured at 20mA on a discrete LED unless otherwise stated.
 Luminous intensities and color shades of white LEDs may vary within a batch.
 LED characteristics are dependent upon environmental conditions. Therefore published data should be considered nominal.

Technical Drawings

PROMINENT BEZEL

