

**Ordering number C12480_MIRELLA-50-S-PIN**

Family	Mirella	FWHM	11 degrees
Type	Reflector	Efficiency	92 %
LED	NS9x383	cd/lm	11.800
Color	Metal	Gerber File	Available
Diameter	49.9 mm		
Height	23.9 mm		
Style	Round		
Optic Material	PC		
Holder Material	-		
Fastening	Pin		
Status	Ready		

Please note that the position pin holes come very close to the L

**Ordering number CN12486_MIRELLA-50-S-PIN-DL**

Family	Mirella	FWHM	14 degrees
Type	Pack	Efficiency	85 %
LED	NS9x383	cd/lm	6.100
Color	Metal	Gerber File	Available
Diameter	49.9 mm		
Height	23.9 mm		
Style	Round		
Optic Material	PC		
Holder Material	-		
Fastening	Pin		
Status	Ready		

Please note that the position pin holes come very close to the L

**Ordering number C12481_MIRELLA-50-M-PIN**

Family	Mirella	FWHM	24 degrees
Type	Reflector	Efficiency	88 %
LED	NS9x383	cd/lm	2.450
Color	Metal	Gerber File	Available
Diameter	49.9 mm		
Height	23.9 mm		
Style	Round		
Optic Material	PC		
Holder Material	-		
Fastening	Pin		
Status	Ready		

Please note that the position pin holes come very close to the L

**Ordering number CN12487_MIRELLA-50-M-PIN-DL**

Family	Mirella	FWHM	32 degrees
Type	Pack	Efficiency	83 %
LED	NS9x383	cd/lm	1.700
Color	Metal	Gerber File	Available
Diameter	49.9 mm		
Height	23.9 mm		
Style	Round		
Optic Material	PC		
Holder Material	-		
Fastening	Pin		
Status	Ready		

Please note that the position pin holes come very close to the L

**Ordering number C12482_MIRELLA-50-W-PIN**

Family	Mirella	FWHM	39 degrees
Type	Reflector	Efficiency	89 %
LED	NS9x383	cd/lm	1.500
Color	Metal	Gerber File	Available
Diameter	49.9 mm		
Height	23.9 mm		
Style	Round		
Optic Material	PC		
Holder Material	-		
Fastening	Pin		
Status	Ready		

Please note that the position pin holes come very close to the L

**Ordering number CN12488_MIRELLA-50-W-PIN-DL**

Family	Mirella	FWHM	46 degrees
Type	Pack	Efficiency	83 %
LED	NS9x383	cd/lm	1.150
Color	Metal	Gerber File	Available
Diameter	49.9 mm		
Height	23.9 mm		
Style	Round		
Optic Material	PC		
Holder Material	-		
Fastening	Pin		
Status	Ready		

Please note that the position pin holes come very close to the L

NOTE: The typical divergence will be changed by different color, chip size and chip position tolerance. The typical total divergence is the full angle measured where the luminous intensity is half of the peak value.



PRODUCT DATASHEET

Mirella series

last update 27/3/2013



GENERAL INFORMATION

- Product series especially designed & optimized for NS9x383 series of LEDs.
- Special care taken to make light distribution as uniform as possible.
- Reflector is made of aluminium coated PC (120 degrees of Celcius / 248 degrees of Fahrenheit) with protective lacquer (110 degrees of Celcius / 230 degrees of Fahrenheit).

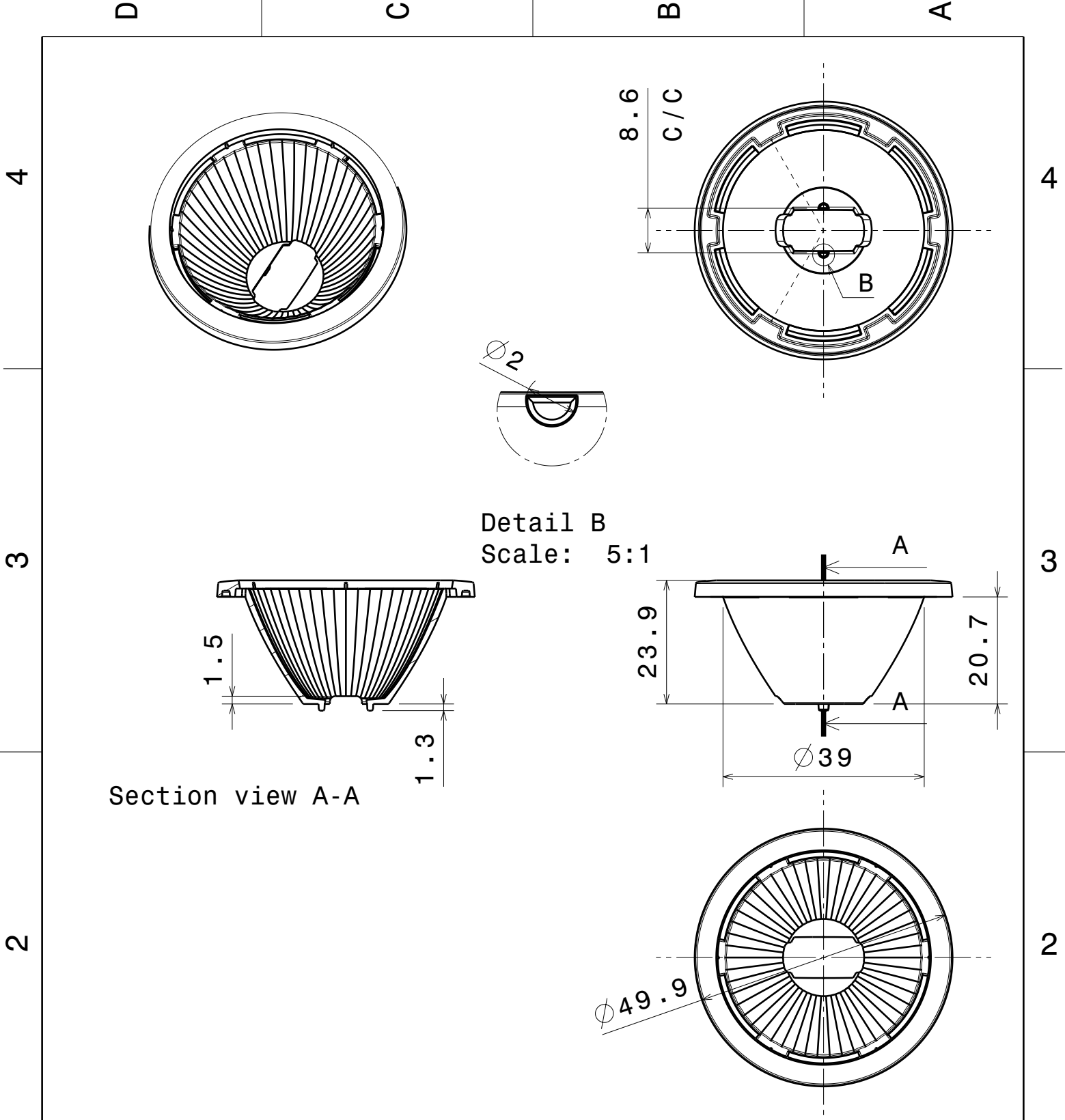

Section view A-A

Detail B
Scale: 5:1

Material: PC, metal plated

This drawing is our property.
It can't be reproduced
or communicated without
our written agreement.



Ledil Oy
Salorankatu 10
FIN-24240 SALO
Finland

DRAWING TITLE

Datasheet Mirella pin reflector

DRAWN BY pl		DATE 25.11.2011		SIZE A4		DRAWING NUMBER		REV 1	
CHECKED BY		DATE		SCALE 1:1		WEIGHT (g)		SHEET 1/1	
DESIGNED BY pl		DATE 25.11.2011							

D

A

Luminaire: LEDiL Oy C12480_MIRELLA-50-S-PIN_(NS9x383) Eff 91,7%
Lamps: 1 x Nichia NS9x383 (105lm@250mA)

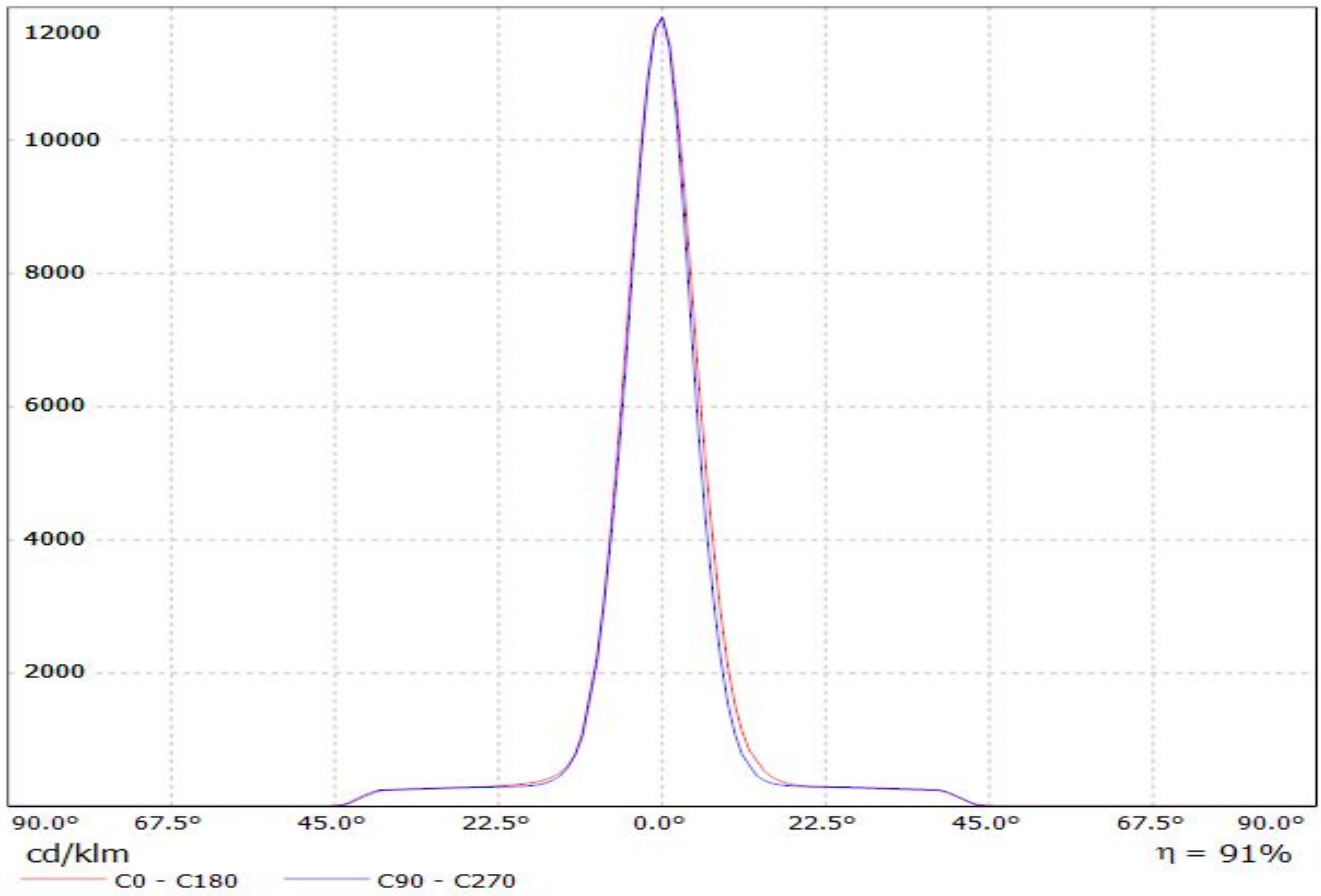

Luminaire: LEDiL Oy CN12486_MIRELLA-50-S-PIN-DL Eff. 85,1%
Lamps: 1 x Nichia NS9x383 (105lm@250mA)

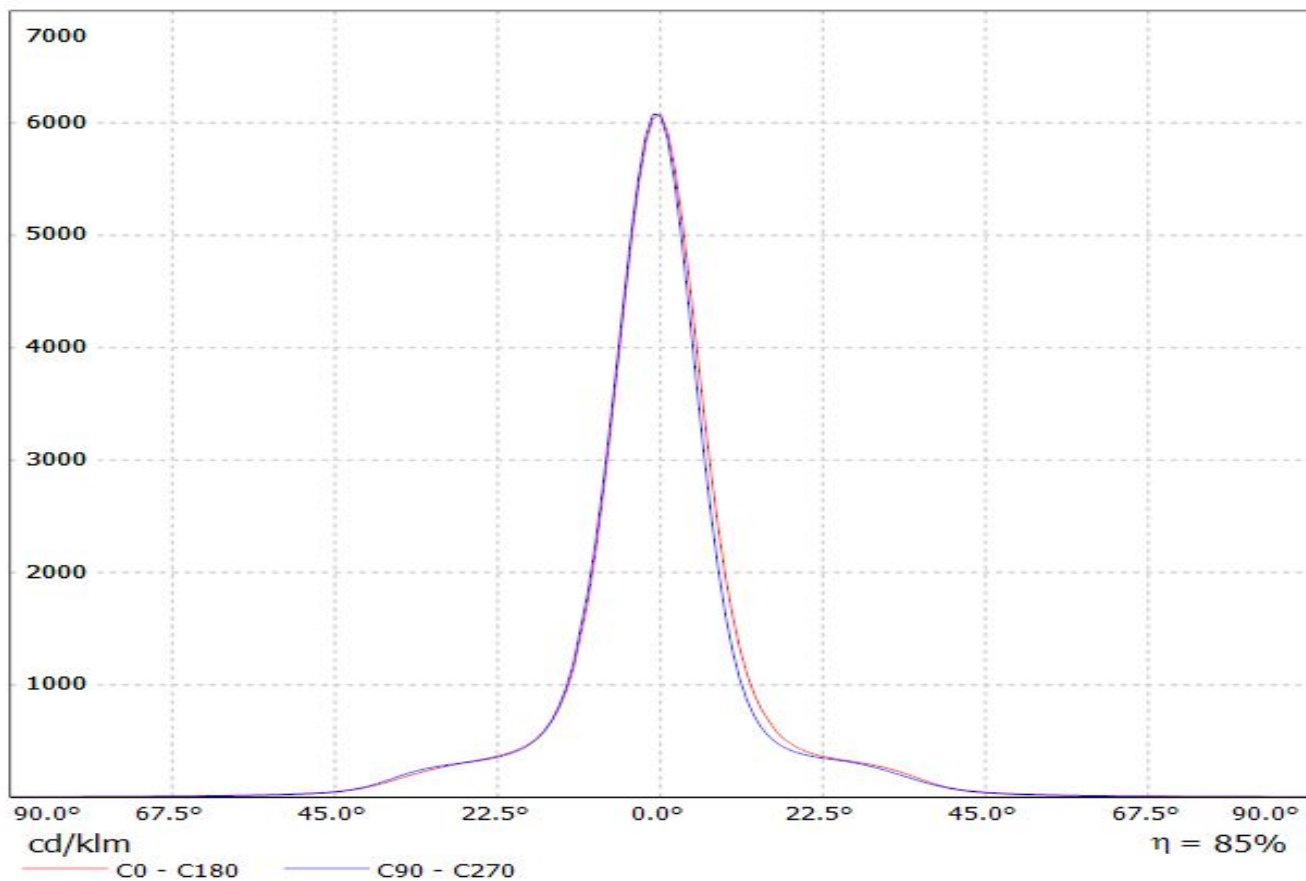

Luminaire: LEDiL Oy C12481_MIRELLA-50-M-PIN_(NS9x383) Eff. 88,3%
Lamps: 1 x Nichia NS9x383 (105lm@250mA)

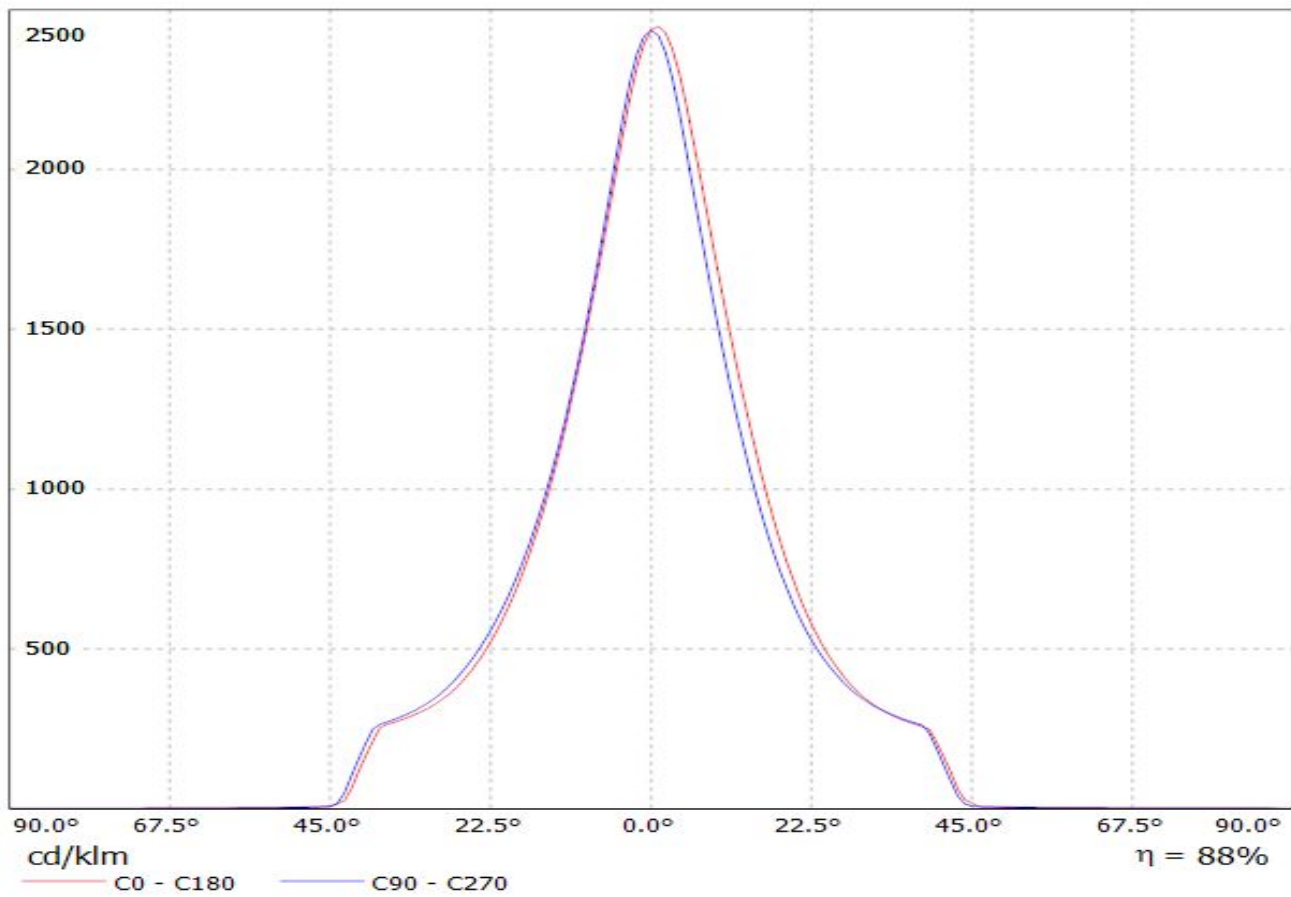

Luminaire: LEDiL Oy CN12487_MIRELLA-50-M-PIN-DL_(NS9x383) Eff. 82,5%
Lamps: 1 x Nichia NS9x383 (105lm@250mA)

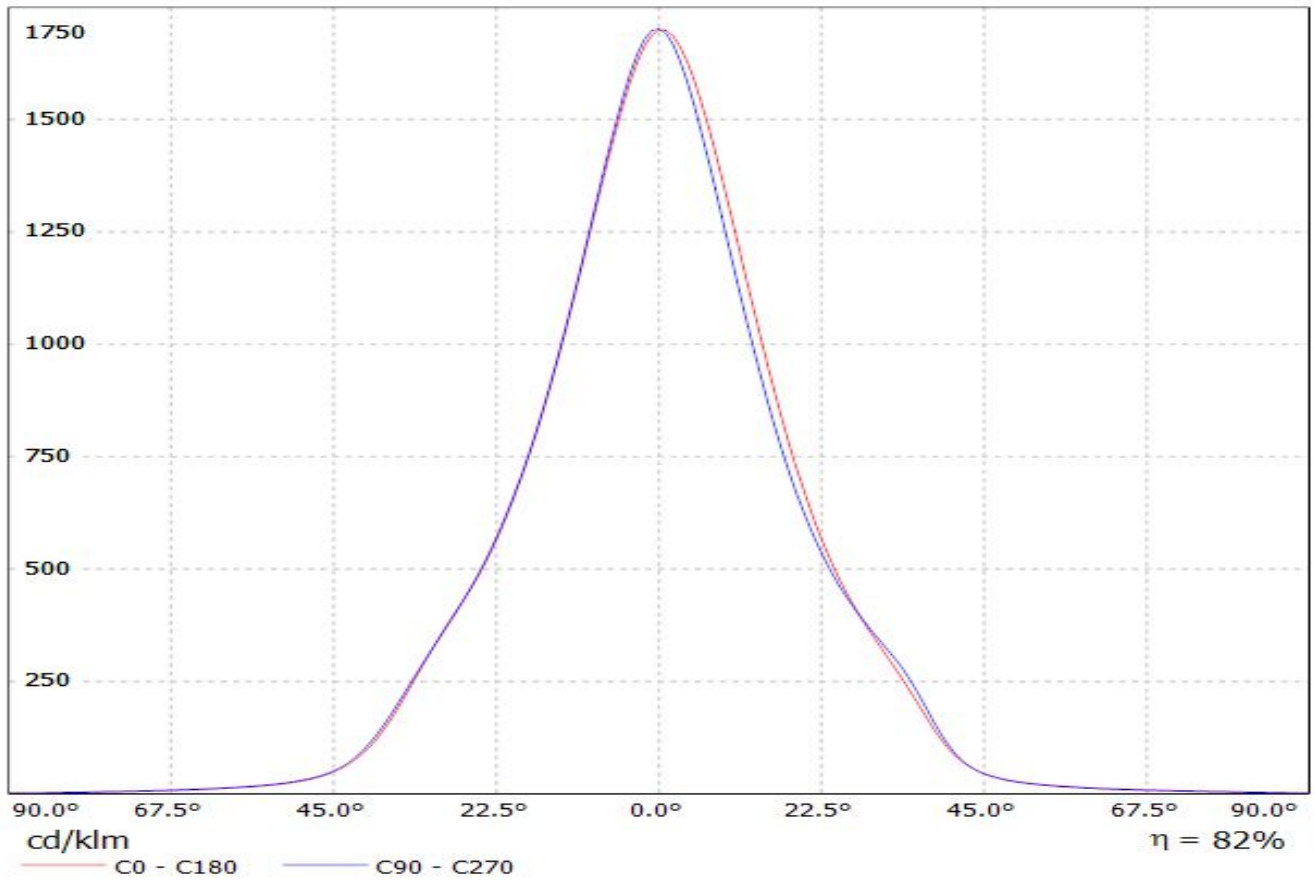

Luminaire: LEDiL Oy C12482_MIRELLA-50-W-PIN_(NS9x383) Eff. 88,5%
Lamps: 1 x Nichia NS9x383 (105lm@250mA)

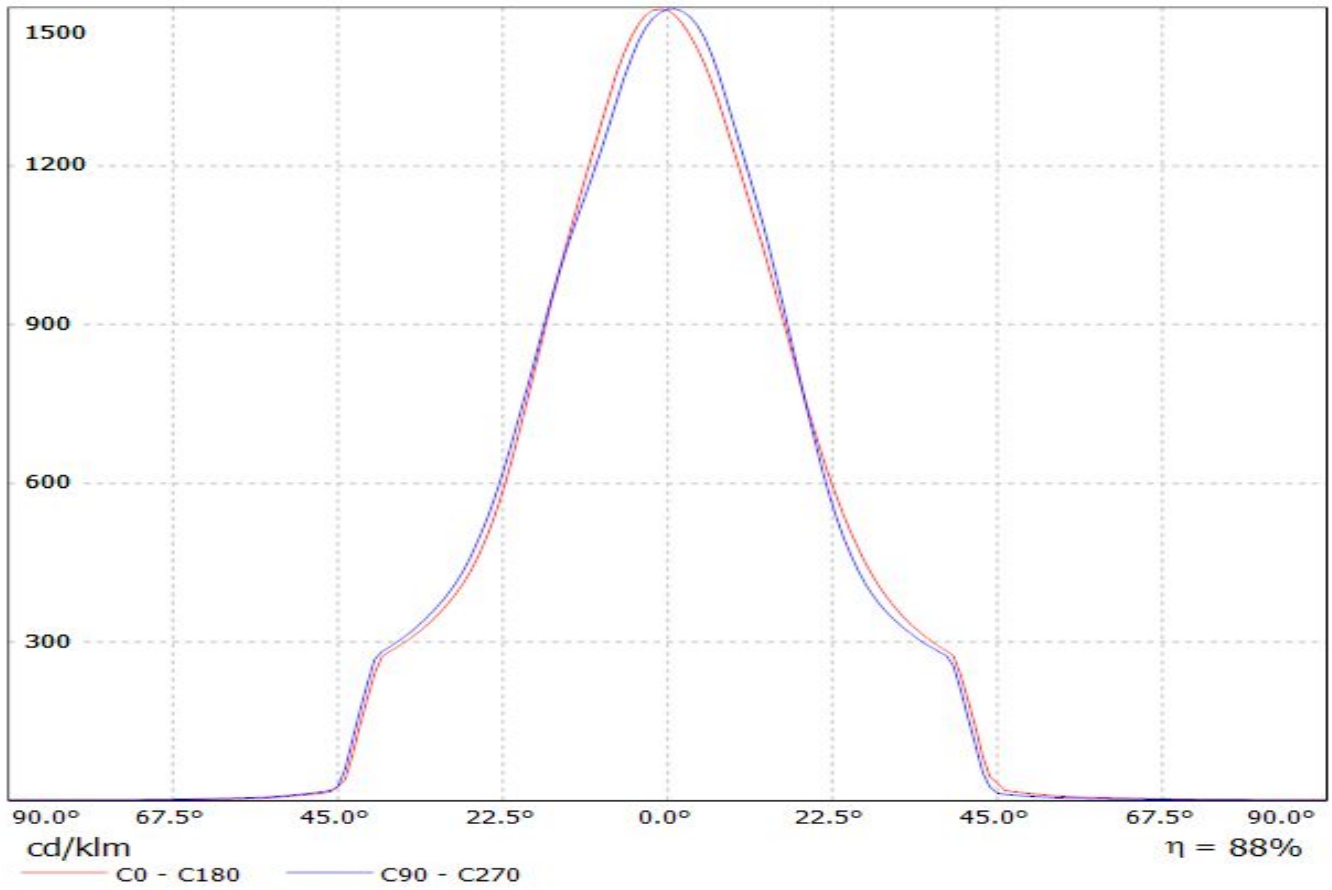

Luminaire: LEDiL Oy CN12488_MIRELLA-50-W-PIN-DL_(NS9x383) Eff. 82,5%
Lamps: 1 x Nichia NS9x383 (105lm@250mA)

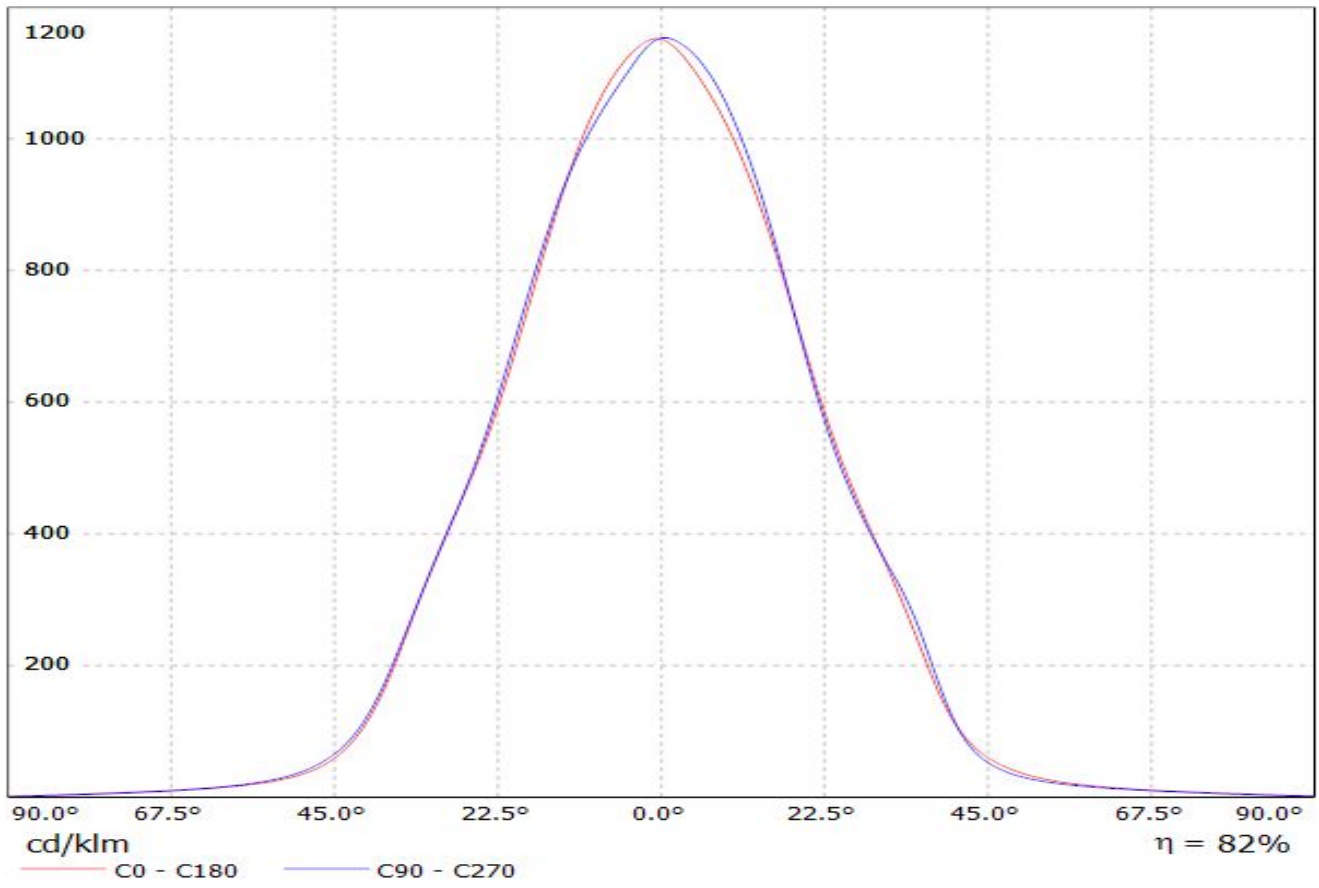

Luminaire: LEDiL Oy C12480_MIRELLA-50-S-PIN_(NS9x383) Eff 91,7%
Lamps: 1 x Nichia NS9x383 (105lm@250mA)

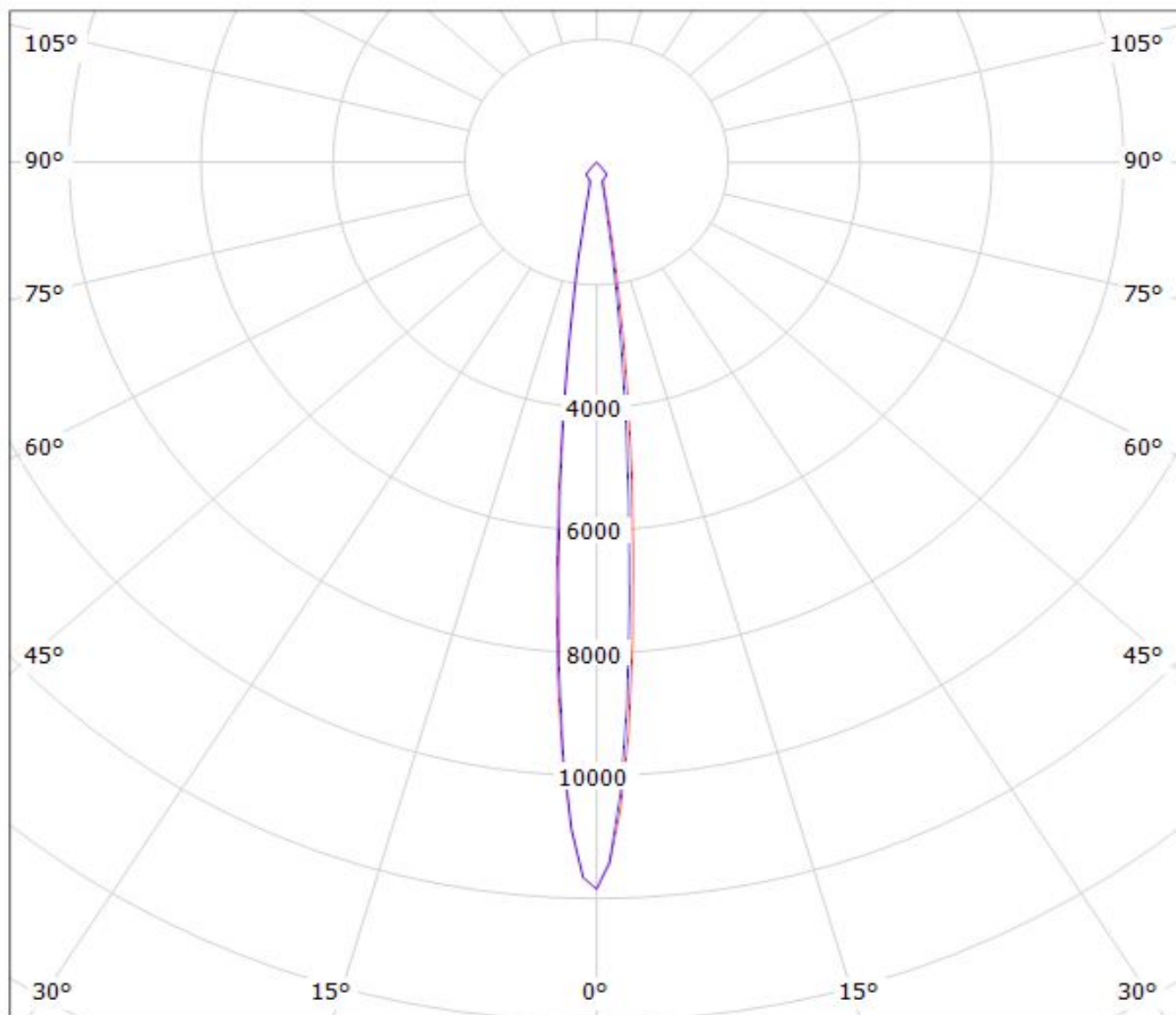

cd/klm

$\eta = 91\%$

— C0 - C180 — C90 - C270

Luminaire: LEDiL Oy CN12486_MIRELLA-50-S-PIN-DL Eff. 85,1%
Lamps: 1 x Nichia NS9x383 (105lm@250mA)

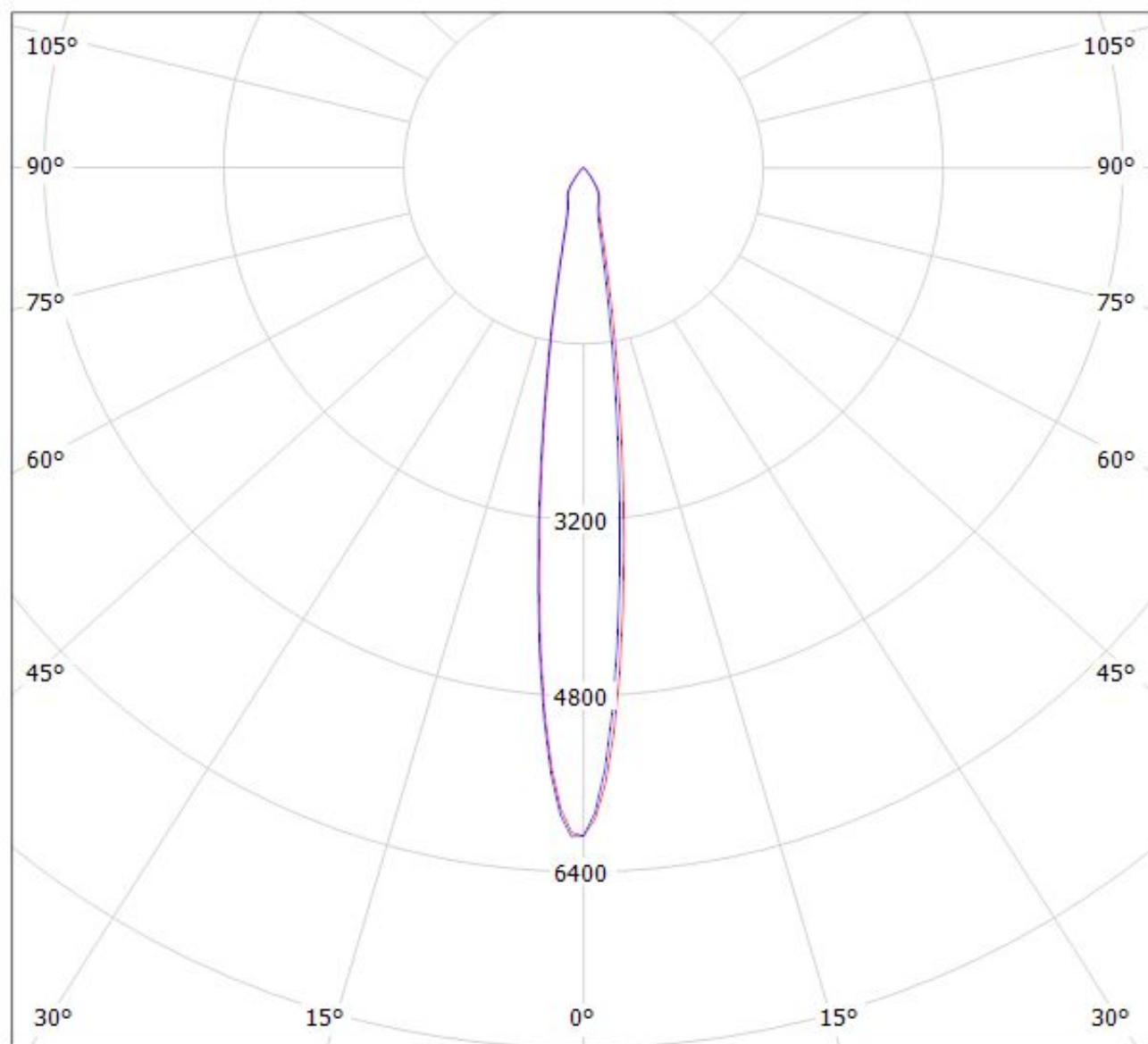

cd/klm

$\eta = 85\%$

— C0 - C180 — C90 - C270

Luminaire: LEDiL Oy C12481_MIRELLA-50-M-PIN_(NS9x383) Eff. 88,3%
Lamps: 1 x Nichia NS9x383 (105lm@250mA)

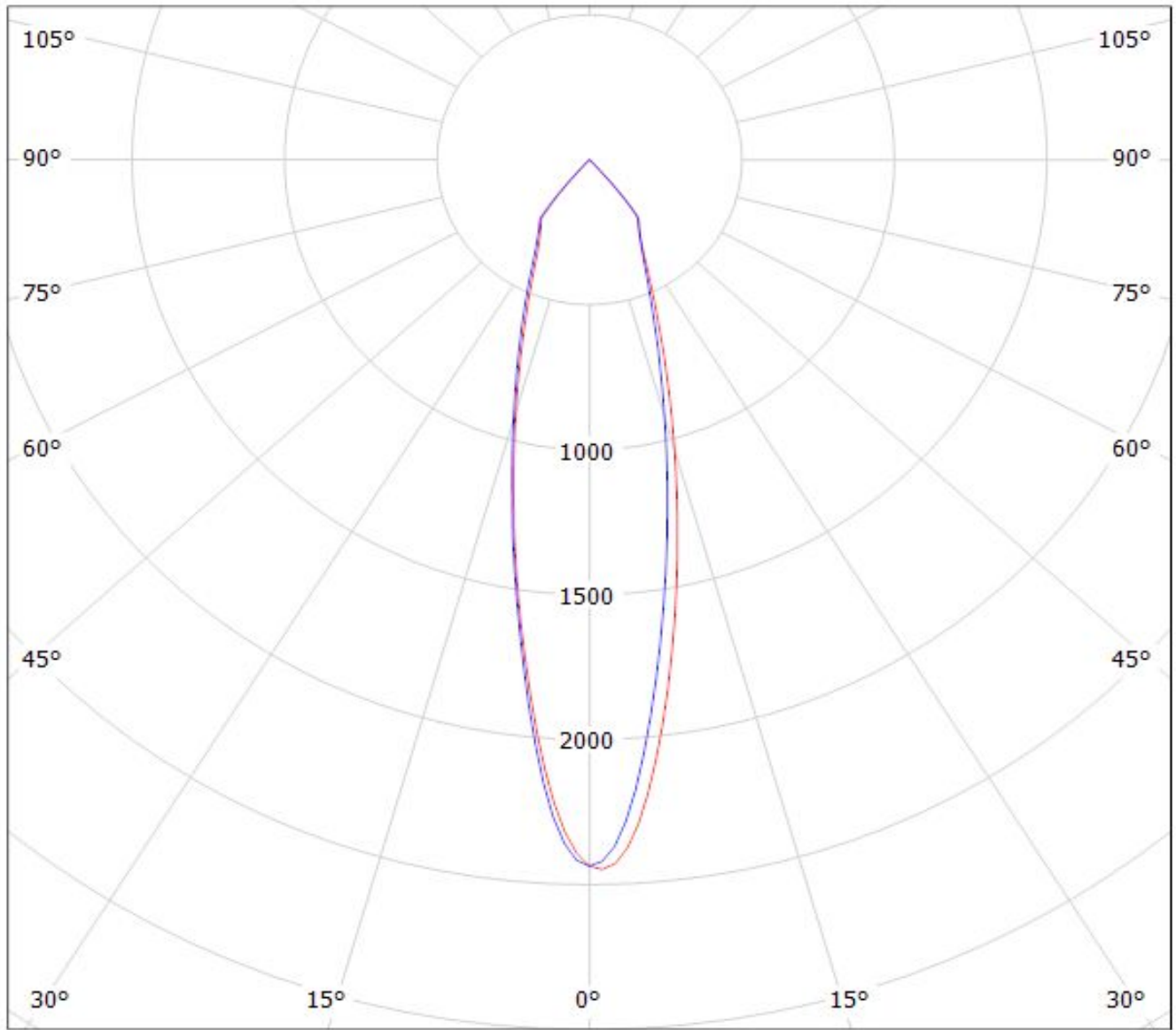

cd/klm

— C0 - C180 — C90 - C270

$\eta = 88\%$

Luminaire: LEDiL Oy CN12487_MIRELLA-50-M-PIN-DL_(NS9x383) Eff. 82,5%

Lamps: 1 x Nichia NS9x383 (105lm@250mA)

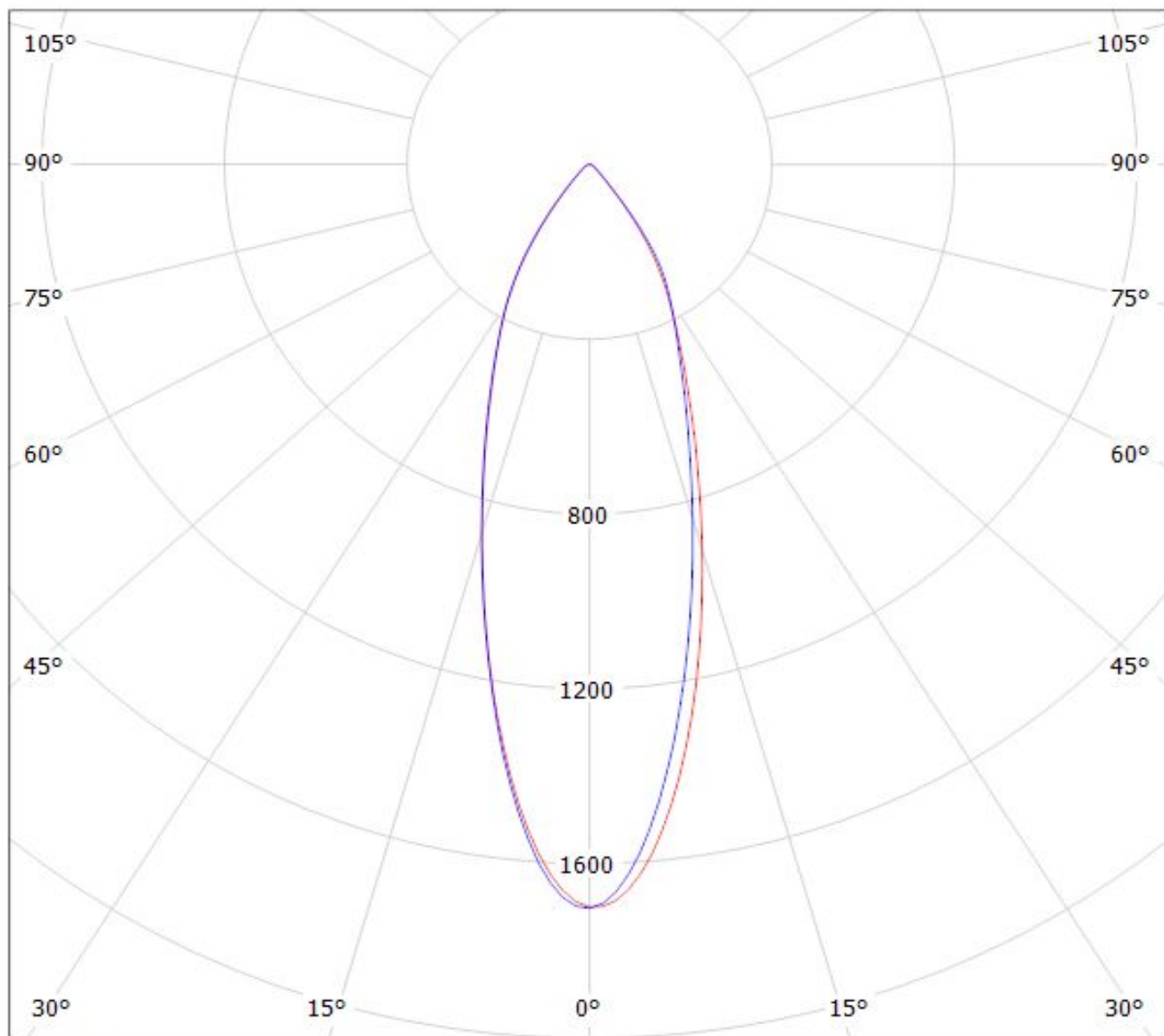

cd/klm

— C0 - C180

— C90 - C270

$\eta = 82\%$

Luminaire: LEDiL Oy C12482_MIRELLA-50-W-PIN_(NS9x383) Eff. 88,5%

Lamps: 1 x Nichia NS9x383 (105lm@250mA)

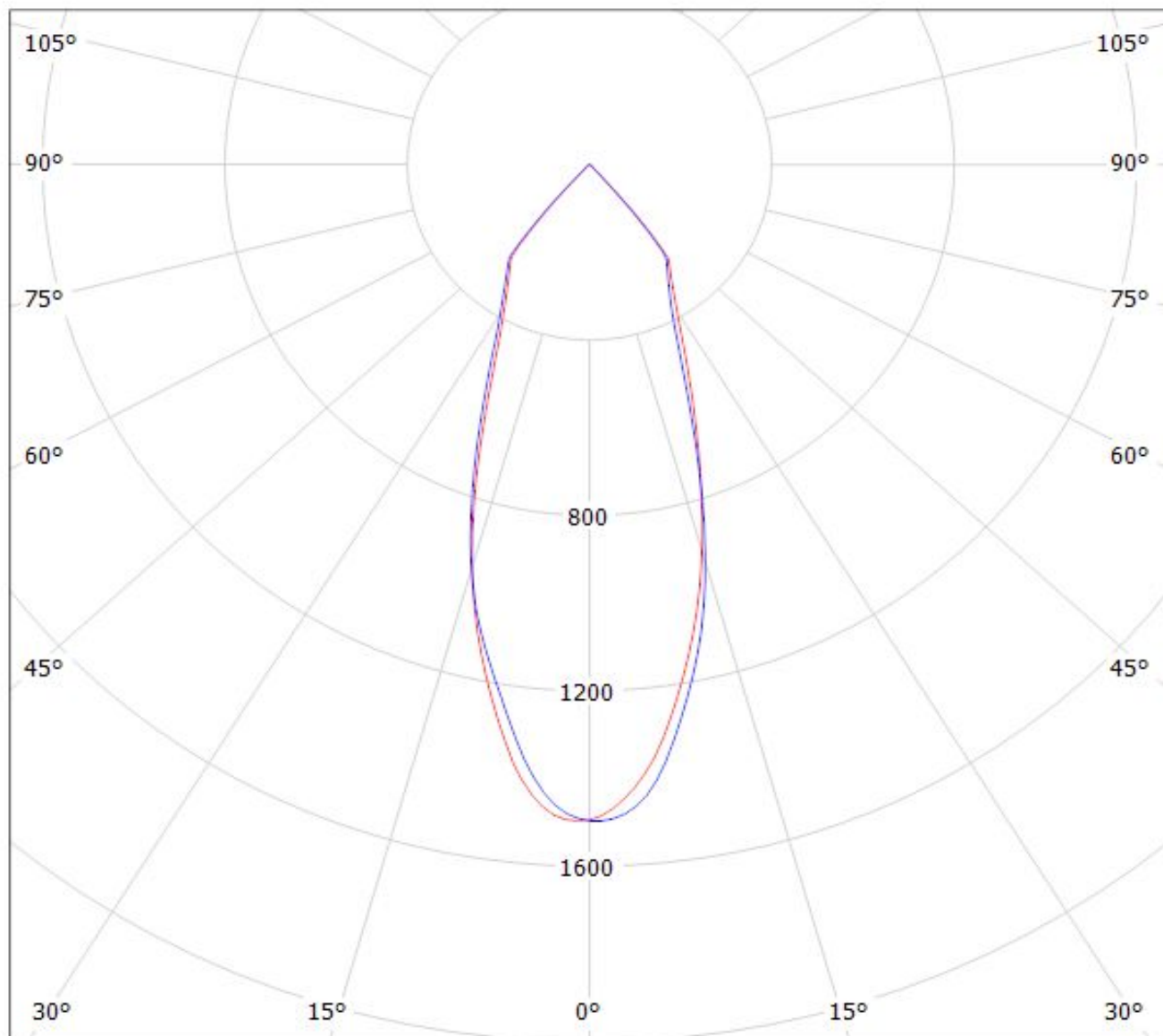

cd/klm

— C0 - C180

— C90 - C270

$\eta = 88\%$

Luminaire: LEDiL Oy CN12488_MIRELLA-50-W-PIN-DL_(NS9x383) Eff. 82,5%
Lamps: 1 x Nichia NS9x383 (105lm@250mA)

