



FNP1500/1800 front-ends have front-mounted AC input receptacles.

### Applications

- Telecommunications
- Data communications
- Servers
- Distributed power

### Features

- RoHS compliant for all six substances
- High density front-ends 15.2 to 18.3 W/in<sup>3</sup>
- Wide input voltage range 85 to 264 VAC
- 12 V standby voltage, 1A per front-end
- Highly efficient topology reduces operating costs
- I<sup>2</sup>C interface status and control
- I<sup>2</sup>C voltage and current limit setting
- Analog output voltage setting
- Overtemperature, output overvoltage, and output overcurrent protection
- ORing circuits for true redundant operation: V<sub>o1</sub>: ORing FETs; V<sub>o2</sub>: ORing Diodes
- Status LEDs: AC OK, DC OK, and Fan Fail/Overtemperature Fail

FNR-3  
Power Shelf



FNR-3 shelves provide up to 5400 watts in a 19" rack.  
(See the Rack section for power shelf details.)



### Description

The FNP1500/1800 front-ends are power-factor-corrected (PFC) which (depending on model type) provide a 12 VDC or 48 VDC (1500 or 1800 watt) output, and can be used in hot-swap redundant systems. Their very small dimensions allow configuration of up to three units in a 1U rack. The FNP front-ends have a front-mounted AC receptacle. The highly efficient thermal design with internal-fan cooling permits their use over wide temperature ranges and provides very high reliability.

Status information is provided with front panel LEDs, logic signals, and via an I<sup>2</sup>C management interface. In addition, the I<sup>2</sup>C bus can enable the power supply, set high fan speed, adjust the output voltage, and set the output current limit. The FNP1500/1800's meet international safety standards and display the CE-Mark for the European Low Voltage Directive (LVD).

FNR-3-12G and FNR-3-48G power-shelf solutions provide rectification, system management, and power distribution, while maintaining high reliability and offering flexibility for future expansion. The power shelves can be configured with up to three hot-swappable 1500 or 1800-watt AC-DC front-ends.

## Model Selection

Model	Input voltage VAC auto selected <sup>1</sup>	Output 1		Output 2		Rated power W	Compatible Shelf <sup>2</sup>
		V <sub>o1 nom</sub> VDC	I <sub>o1 max</sub> ADC	V <sub>o2 nom</sub> VDC	I <sub>o2 max</sub> ADC		
FNP1500-12G	108 – 264	12	129 @ 11.64V	12	1	1512	FNR-3-12G
	85 – 105	12	101.8 @ 11.78A	12	1	1212	
FNP1500-48G	105 – 264	48	32.2	12	1	1512	FNR-3-48G
	85 – 105	48	25.4	12	1	1212	
FNP1800-12G	180 – 264	12	150 @ 11.52V	12	1	1740	FNR-3-12G
	105 – 180	12	129 @ 11.64V	12	1	1512	
	85 – 105	12	101.8A @ 11.78V	12	1	1212	
FNP1800-48G	180 – 264	48	39.2	12	1	1812	FNR-3-48G
	105 – 180	48	32.2	12	1	1512	
	85 – 105	48	25.4	12	1	1212	

<sup>1</sup> The available output power is automatically adjusted depending on the input voltage.

<sup>2</sup> 1U standard racks are available from Power-One. See the Rack (Power Shelf) section of this data sheet for configurations and details.

## Absolute Maximum Ratings

Stress in excess of the absolute maximum ratings may cause performance degradation, adversely effect long-term reliability, or cause permanent damage to the converter.

Parameter	Conditions/Description	Min	Max	Unit
Input voltage	Continuous		264	VAC
	Transient, 60 ms max.		300	VAC
Operating ambient temperature	V <sub>i min</sub> -V <sub>i max</sub> , I <sub>o nom</sub> , cooling by internal fan			
	@ 100 % load	0	50	°C
	@ 50 % load	0	70	°C
Storage temperature	Non-Operating	-40	85	°C

## Environmental, Mechanical, & Reliability Specifications

Parameter	Conditions/Description	Min	Nom	Max	Unit
Altitude	Operating			10 k	ASL Ft.
	Non-Operating			40 k	ASL Ft.
Relative humidity, non-condensing	Operating	10		90	% RH
	Storage	5		95	% RH
Temperature coefficient	0 °C to 70 °C (after 15 min warm-up)			0.02	%/K
Shock	IEC/EN 60068-2-27, 11 ms			40	g <sub>pk</sub>
Sinusoidal vibration	IEC/EN 60068-2-6 2-8 Hz 8-200 Hz 200-500 Hz		7.5		mil
			2		g <sub>pk</sub>
			4		g <sub>pk</sub>
					g <sub>rms</sub>
Random vibration	10-2000 Hz		6.15		g <sub>rms</sub>
MTBF	Calculated per Bellcore (SR-332, Issue 1):				
	GB 25 °C	230			kh
	GB 25 °C (FNP1500-12G) Demonstrated	TBD 250			kh kh

## Safety Specifications

Maximum electric strength testing is performed in the factory according to EN 550116, IEC/EN 60950, and UL 60950. Input-to-output electric strength tests should not be repeated in the field. Power-One will not honor any warranty claims resulting from electric strength field tests.

Parameter	Conditions/description	Min	Nom	Max	Unit
Agency approvals	UL60950, (UL) CSA 60950 (cUL), EN 60950(TÜV), CE Mark for LVD				
Insulation safety rating	Input to case Input to output Output to case		Basic Reinforced Functional		
Electric strength test voltage	Input to case Input to output Output to case Output 1 to output 2	2.12 4.2 <sup>1</sup> 0.5 0.1			kVDC kVDC kVDC kVDC

<sup>1</sup> Subassemblies are pre-tested with 4.2 kVDC in accordance with EN50116 and IEC/EN60950.

## EMC Specifications

Parameter	Description	Criterion
Electrostatic discharge	IEC/EN 61000-4-2, level 4	Performance criterion B
Electromagnetic field	IEC/EN 61000-4-3, level 3	Performance criterion A
Electrical fast transients/burst	IEC/EN 61000-4-4, level 3	Performance criterion B
Surge	IEC/EN 61000-4-5, level 3	Performance criterion B
Voltage dips and interruptions	IEC/EN 61000-4-11	Performance criterion B or better
RF conducted immunity	IEC/EN 61000-4-6	10 VAC, AM 80 %, 1 kHz Performance criterion A
Emissions conducted	CISPR 22/EN 55022/EN 61204	Class B
Emissions radiated	CISPR 22/EN 55022/EN 61204	Class A
Harmonics	IEC/EN 61000-3-2	Class B
Voltage fluctuation and flicker	IEC/EN 61000-3-3	Pass
Voltage sag	SEMI F47-0200 (High Line 230V)	Pass

## Input Specifications

Specification is valid for input voltage, load, and temperature ranges, unless otherwise stated.

Parameter	Conditions/description	Min	Nom	Max	Unit
Input voltage		85	230	264	VAC
Input frequency		47	50/60	63	Hz
Turn-on input voltage	Ramping up	79		85	VAC
Turn-off input voltage	Ramping down	70		78	VAC
Inrush current limitation	115/230 VAC acc. ETS 300 132-1 < 100 ms			50	A <sub>pk</sub>
Hold-up time	After last AC line peak, V <sub>i</sub> = 230 VAC, P <sub>o nom</sub>	20			ms
Power factor	V <sub>i nom</sub> , I <sub>o nom</sub>	0.95			W/VA
Efficiency	V <sub>i</sub> = 230 VAC, I <sub>o nom</sub> , T <sub>C</sub> = 25 °C	89 <sup>1</sup>	90		%
Max input current				20	A <sub>rms</sub>
Input connector	16A – 20 A / 250 VAC; according to IEC320 C19				

<sup>1</sup> 87% for FNP1500-12

**Output Specifications, 12Vout Models**

Specification is valid for input voltage, load, and temperature ranges, unless otherwise stated.

Parameter		Conditions/Description	Min	Nom	Max	Units
Nominal output voltage		$I_o = 64.5 \text{ A}$		12		VDC
Output voltage set point accuracy		$V_i = 230 \text{ VAC}$ , $I_{o1} = 65.5 \text{ A}$ , $T_c = 25 \text{ }^\circ\text{C}$ (Factory setting)	11.93 -0.42	12	12.05 +0.42	VDC % $V_{o1 \text{ nom}}$
Output voltage trimming		Adjustable via I <sup>2</sup> C ( $V_{o1 \text{ set}}$ ) Adjustable via Margin pin (R input)	7 6.2	12	13 <sup>1</sup> $V_{o1 \text{ set}}$	VDC VDC
Nominal current output 1	FNP1500-12G	$I_{o1 \text{ nom}}$ @ $V_i = 108 \text{ VAC} - 264 \text{ VAC}$ , $P_o 1.5 \text{ kW}$ $I_{o1 \text{ nom}}$ @ $V_i = 85 \text{ VAC} - 105 \text{ VAC}$ , $P_o 1.2 \text{ kW}$		129.0 101.8	129.0	ADC ADC
	FNP1800-12G	$I_{o1 \text{ nom}}$ @ $V_i = 108 \text{ VAC} - 264 \text{ VAC}$ , $P_o 1.75 \text{ kW}$ $I_{o1 \text{ nom}}$ @ $V_i = 108 \text{ VAC} - 180 \text{ VAC}$ , $P_o 1.5 \text{ kW}$ $I_{o1 \text{ nom}}$ @ $V_i = 85 \text{ VAC} - 105 \text{ VAC}$ , $P_o 1.2 \text{ kW}$		150.0 129.0 101.8	150.0	ADC ADC ADC
Current limit output 1	FNP1500-12G	$I_{o1 \text{ max}}$ @ $V_i = 108 \text{ VAC} - 264 \text{ VAC}$ droop hiccup $I_{o1 \text{ max}}$ @ $V_i = 85 \text{ VAC} - 105 \text{ VAC}$ droop hiccup		147.4 120.2		ADC ADC
	FNP1800-12G	$I_{o1 \text{ max}}$ @ $V_i = 180 \text{ VAC} - 264 \text{ VAC}$ high droop $I_{o1 \text{ lim}}$ @ $V_i = 180 \text{ VAC} - 264 \text{ VAC}$ hiccup $I_{o1 \text{ max}}$ @ $V_i = 108 \text{ VAC} - 180 \text{ VAC}$ high droop $I_{o1 \text{ lim}}$ @ $V_i = 108 \text{ VAC} - 180 \text{ VAC}$ hiccup $I_{o1 \text{ max}}$ @ $V_i = 85 \text{ VAC} - 105 \text{ VAC}$ high droop $I_{o1 \text{ lim}}$ @ $V_i = 85 \text{ VAC} - 105 \text{ VAC}$ hiccup		156.4 168.4 135.4 147.4 108.2 120.2		ADC ADC ADC ADC ADC ADC
Nominal current output 2		$I_{o2 \text{ nom}}$ @ $V_i = 85 \text{ VAC} - 265 \text{ VAC}$ , $P_o 12 \text{ W}$		1.0	1.0	ADC
Current limit output 2		$I_{o2 \text{ max}}$ @ $V_i = 85 \text{ VAC} - 265 \text{ VAC}$		1.5		ADC
Static line regulation output 1		$V_{i \text{ min}} - V_{i \text{ max}}$ , 50 % $I_{o \text{ nom}}$ , $T_a = 25 \text{ }^\circ\text{C}$	-0.5		0.5	% $V_{o \text{ nom}}$
Static load regulation output 1 (droop characteristic)	FNP1500-12G	$V_i = 230 \text{ V}$ , 5 - 100 % $I_{o \text{ nom}}$ Full load to no load [0..129 A] at $V_o \text{ set} = 12 \text{ V}$ $dV_{o1}$ over the setting range [7 to 13V]	11.64 -0.36	- 5.58 12	12.36 +0.36	mV/A VDC VDC
	FNP1800-12G	$V_i = 230 \text{ V}$ , 5 - 100 % $I_{o \text{ nom}}$ Full load to no load [0..150 A] at $V_o \text{ set} = 12 \text{ V}$ $dV_{o1}$ over the setting range [7 to 13V]	11.52 -0.48	- 5.58 12	12.36 +0.36	mV/A VDC VDC
Static load regulation output 2 (droop characteristic)		Full load to no load @ $V_i = 85 \text{ VAC} - 265 \text{ VAC}$		0.4		VDC
Dynamic load regulation		Load change 50% $\leftrightarrow$ 100% $I_{o \text{ nom}}$ , $dI_o/dt = 1 \text{ A}/\mu\text{s}$ Voltage deviation (droop + over- or undershoot)				
	FNP1500-12G & FNP1800-12G		-2		2	% $V_{o \text{ nom}}$
	FNP1500-12G & FNP1800-12G	Max. recovery time to within 1% of $V_{o1 \text{ nom}}$			400	$\mu\text{s}$
Current Share		Difference in current between two units for $V_{o1}$ above 10 % load.				
	FNP1500-12G			12.9		ADC
	FNP1800-12G			15		ADC
Start-up time		Time required for output within regulation after initial application of AC-input ( $V_{i \text{ nom}}$ , $I_{o \text{ nom}}$ ) after removal of inhibit ( $V_{i \text{ nom}}$ , $I_{o \text{ nom}}$ )		100	1.5	s ms
Output voltage ripple and noise (Filter 10nF/10 $\mu\text{F}$ )		$V_{i \text{ nom}}$ , $I_{o \text{ nom}}$ , 20 MHz bandwidth $V_{o1}$ $V_{o2}$			120 120	mV <sub>pp</sub> mV <sub>pp</sub>
Remote sense		Total compensation for cable losses			500	mV

<sup>1</sup> FNP1800-12G max is 12V.

## Output Specifications, 48Vout Models

Specification is valid for input voltage, load, and temperature ranges, unless otherwise stated.

Parameter		Conditions/Description	Min	Nom	Max	Units
Nominal output voltage Vo1		$I_o = 16.1 \text{ A}$		48		VDC
Nominal output voltage Vo2		$I_o = 0.5 \text{ A}$		12		VDC
Output voltage set point accuracy		$V_i = 230 \text{ VAC}$ , $I_{o1} = 16.1 \text{ A}$ , $T_c = 25 \text{ }^\circ\text{C}$ (47.8 - 48.2 VDC)	-0.5		+0.5	% $V_{o1 \text{ nom}}$
Output voltage trimming (via I <sup>2</sup> C or with external resistor)		Adjustable (44.16 to 51.84 VDC)	-8		+8	% $V_{o1 \text{ nom}}$
Nominal current output 1	FNP1500-48G	$I_{o1 \text{ nom}}$ @ $V_i = 105 \text{ VAC} - 264 \text{ VAC}$ , $P_o 1.5 \text{ kW}$		32.2		ADC
		$I_{o1 \text{ nom}}$ @ $V_i = 85 \text{ VAC} - 105 \text{ VAC}$ , $P_o 1.2 \text{ kW}$		25.4		ADC
	FNP1800-48G	$I_{o1 \text{ nom}}$ @ $V_i = 180 \text{ VAC} - 264 \text{ VAC}$ , $P_o 1.8 \text{ kW}$		39.2	39.2	ADC
		$I_{o1 \text{ nom}}$ @ $V_i = 105 \text{ VAC} - 180 \text{ VAC}$ , $P_o 1.5 \text{ kW}$		32.2		ADC
		$I_{o1 \text{ nom}}$ @ $V_i = 85 \text{ VAC} - 105 \text{ VAC}$ , $P_o 1.2 \text{ kW}$		25.4		ADC
Current limit output 1	FNP1500-48G	$I_{o1 \text{ max}}$ @ $V_i = 105 \text{ VAC} - 264 \text{ VAC}$ droop hiccup		36.8		ADC
		$I_{o1 \text{ max}}$ @ $V_i = 85 \text{ VAC} - 105 \text{ VAC}$ droop hiccup		30		ADC
	FNP1800-48G	$I_{o1 \text{ max}}$ @ $V_i = 180 \text{ VAC} - 264 \text{ VAC}$ droop hiccup		43.8		ADC
		$I_{o1 \text{ max}}$ @ $V_i = 105 \text{ VAC} - 180 \text{ VAC}$ droop hiccup		36.8		ADC
		$I_{o1 \text{ max}}$ @ $V_i = 85 \text{ VAC} - 105 \text{ VAC}$ droop hiccup		30		ADC
Nominal current output 2		$I_{o2 \text{ nom}}$ @ $V_i = 85 \text{ VAC} - 264 \text{ VAC}$ , $P_o 12 \text{ W}$		1.0	1.0	ADC
Current limit output 2		$I_{o2 \text{ max}}$ @ $V_i = 85 \text{ VAC} - 264 \text{ VAC}$		1.5		ADC
Static line regulation output 1		$V_{i \text{ min}} - V_{i \text{ max}}$ , 50 % $I_{o \text{ nom}}$	-0.5		0.5	% $V_{o \text{ nom}}$
Static load regulation output 1 (droop characteristic)	FNP1500-48G	$V_i = 230 \text{ V}$ , 5-100 % $I_{o \text{ nom}}$ $V_o$ : full load (32.2 ADC) to no load	46.54	90.1 48	49.44	mV/A VDC
	FNP1800-48G	$V_i = 230 \text{ V}$ , 5-100 % $I_{o \text{ nom}}$ $V_o$ : full load (32.2 ADC) to no load	45.91	90.1 48	49.44	mV/A VDC
Static load regulation output 2 (droop characteristic)		$V_i = 230 \text{ V}$ , 5-100 % $I_{o \text{ nom}}$ $V_o$ : full load (32.2 ADC) to no load		0.4		VDC
Dynamic load regulation	Load change 50% ↔ 100% $I_{o \text{ nom}}$ , $di_o/dt = 1 \text{ A}/\mu\text{s}$ Voltage deviation (droop + over- or undershoot)					% $V_{o \text{ nom}}$
	FNP1500-48G		-5		5	% $V_{o \text{ nom}}$
	FNP1800-48G		-5.7		5.7	% $V_{o \text{ nom}}$
	All models	Max. recovery time to within 1 % of $V_{o1 \text{ nom}}$			400	μs
Current Share	Difference in current between two units for $V_{o1}$ above 10 % load.					
	FNP1500-48G				3.2	ADC
	FNP1800-48G				3.9	ADC
Start-up time		Time required for output within regulation after initial application of AC-input ( $V_{i \text{ nom}}$ , $I_{o \text{ nom}}$ ) after removal of inhibit ( $V_{i \text{ nom}}$ , $I_{o \text{ nom}}$ )		100	1.5	s ms
Output voltage ripple and noise (Filter 10 nF/10 μF)		$V_{i \text{ nom}}$ , $I_{o \text{ nom}}$ , 20 MHz bandwidth $V_{o1}$ $V_{o2}$			480 120	mV <sub>pp</sub> mV <sub>pp</sub>
Remote sense		Total compensation for cable losses			500	mV

## Protection

Parameter	Conditions/Description	Min	Nom	Max	Unit
Input fuse	Not user accessible	25A, fast blow			
Inrush current limitation		With NTCs			
Output		No-load -, short circuit - and overload proof			
Overvoltage protection latching <sup>1</sup>	Tracking Absolute for 48V models Absolute for 12V models	115		122 59.5 16.85	% $V_{o\ nom}$ V V
Overtemperature protection	Automatic power shutdown at $T_C$		95		°C

<sup>1</sup> Remove input voltage to reset.

## Control

Specification is valid for input voltage, load, and temperature ranges, unless otherwise stated.

Parameter	Conditions/Description
Status Indication	LEDs: DC OK (green), AC OK (green); fan fail and overtemperature (amber)
I <sup>2</sup> C digital bus	Monitors alarm functions and sets parameters
PS present pin	Contact closure to logic ground ( internal pull-down resistor of 1 kΩ)
PS remote shutdown / Inhibit pin	TTL compatible signal, inhibited when open contact, high or at TTL logic "1". Signal referenced to logic return (LRTN)
Power supply OK (I <sup>2</sup> C) <sup>1</sup>	AC OK & DC OK & no overcurrent & no overtemperature & fans working
DC current fail (I <sup>2</sup> C) <sup>1</sup>	Overcurrent on $I_{o1}$
AC fail / Power down warning (I <sup>2</sup> C & OC) <sup>2</sup>	Provides a warning that the input power has failed at least 5 ms before the output falls out of regulation (<90% $V_{o1\ set}$ ). Open collector signal with 20 mA pull-down capability, referenced to logic return (LRTN). AC fail will go high or open during power fail condition and will go low when input is within the operating range. A Power Fail warning will turn off the green AC OK LED.
DC fail / Output voltage fault (I <sup>2</sup> C & OC) <sup>2</sup>	Internal undervoltage and overvoltage supervision of $V_{o1}$ . Open collector signal with 20 mA pull-down capability, referenced to logic return (LRTN). DC fail will go high or open if $V_{o1}$ is < 90% or > 110% of $V_{o1\ set}$ , measured in front of the ORing FETs. A green LED on the front panel indicates normal operation. The LED will flash if in parallel operation $V_{o1}$ is OK, but the unit is disabled.
Temperature warning (I <sup>2</sup> C & OC) <sup>2</sup>	I <sup>2</sup> C critical temperature warning: Indicates that the operating temperature has reached $[T_{shut-down} - 10K]$ I <sup>2</sup> C & OC overtemperature warning: Indicates if the unit is in overtemperature shutdown. Open collector signal with 20 mA pull-down capability, referenced to logic return (LRTN). The OC-output will go low 100 ms before an overtemperature condition shuts down the unit. An amber LED on the front panel indicates overtemperature or fan fail.
DC voltage monitoring (I <sup>2</sup> C) <sup>1</sup>	Monitors the voltage $V_{o1}$ at the output connector. Accuracy $\pm 0.45$ V over setting range, temperature and load.
DC current monitoring (I <sup>2</sup> C) <sup>1</sup>	Monitors the output current $I_{o1}$ : Accuracy $\pm 0.4A$ over the load range.
DC voltage trimming (I <sup>2</sup> C or external resistor) <sup>1</sup>	Output voltage trimming $V_{o1}$ : $\pm 8$ % of $V_{o\ set}$ Setting accuracy over I <sup>2</sup> C: $\pm 50mV$ at $V_o\ nom$ , $\pm 150$ mV over setting range
Fan speed control (I <sup>2</sup> C) <sup>1</sup>	Two fan speed levels automatically set depending on the internal temperature. The fan speed can be set to full speed or automatic control.
Fan OK (I <sup>2</sup> C & OC) <sup>2</sup>	Indicates if the fans are operating or have failed.
Synch. startup pin	Overcurrent signal which can be used for synchronous startup of units in parallel or to recover from an overload condition. (See application note).

<sup>1</sup> Detailed I<sup>2</sup>C information is available from the model's I<sup>2</sup>C Manual found on the Power-One web site.

<sup>2</sup> Provided over the I<sup>2</sup>C interface and as an open collector signal on the output connector (OC).

**Output Connector Pinning and Signal Specification**

Output Connector Description	Pin Location	Type	Low level High level	V max I max
Overtemperature / Fan Fail	U1	OC-output, protected by 16 V Zener diode and a 10 $\Omega$ resistor in series, referenced to logic GND	< 0.4 V @ 20 mA Pull up	15 V 20 mA
AC Fail / Power down warning	U2	OC-output, protected by 16 V Zener diode and a 10 $\Omega$ resistor in series, referenced to logic GND	< 0.4 V @ 20 mA Pull up	15 V 20 mA
Power Supply Present	U3	Resistor (1 k $\Omega$ ) connected to logic GND	Open Pull up	10 V 10 mA
DC Fail / Output voltage fault	U4	OC-output, protected by 16 V Zener diode and a 10 $\Omega$ resistor in series, referenced to logic GND	< 0.4 V @ 20 mA Pull up	15 V 20 mA
Internal ground	U5	Internal ground ( $V_{o1-}$ line before the output filter). Do not connect the internal grounds in systems with several units.		
ADDR0, I <sup>2</sup> C address bus	T1	DIP switch or wire to internal ground, Internally pull up to 5V (10 k $\Omega$ ).	Switch closed Switch open	5V
ADDR1, I <sup>2</sup> C address bus	T2	DIP switch or wire to internal ground, Internally pull up to 5V (10 k $\Omega$ ).	Switch closed Switch open	5V
ADDR2, I <sup>2</sup> C address bus	T3	DIP switch or wire to internal ground, Internally pull up to 5V (10 k $\Omega$ ).	Switch closed Switch open	5V
ADDR3, I <sup>2</sup> C address bus	T4	DIP switch or wire to internal ground, Internally pull up to 5V (10 k $\Omega$ ).	Switch closed Switch open	5V
ADDR4, I <sup>2</sup> C address bus	T5	DIP switch or wire to internal ground, Internally pull up to 5V (10 k $\Omega$ ).	Switch closed Switch open	5V
DATA, I <sup>2</sup> C data line	S1	I <sup>2</sup> C compatible signal referenced to logic GND	5 V or 3.3 V logic	
CLOCK, I <sup>2</sup> C clock line	S2	I <sup>2</sup> C compatible signal referenced to logic GND	5 V or 3.3 V logic	
$V_{o2+}$ output	S3	Auxiliary power pin, insulated from main output		
$V_{o2-}$ output	S4	Auxiliary ground pin, insulated from main output		
Logic ground	S5	Internally connected over 10 $\Omega$ to Auxiliary GND. Wire separately from Auxiliary - and main output GND to minimize noise on signals and I <sup>2</sup> C. Leave open if not used.		
Output inhibit	R1	PS active when pulled low (DC-DC stage off when left open) Referenced to logic GND	< 0.8 V > 2.0 V	10 V 3.5 mA
V sense +	R2	Open or connected to $V_{o1+}$ at the load (Internally connected to $V_{o1+}$ over 100 $\Omega$ )		$dU < 3 V_{pp}$ 30 mA
V sense -	R3	Open or connected to $V_{o1-}$ at the load (Internally connected to $V_{o1-}$ over 100 $\Omega$ )		$dU < 3 V_{pp}$ 30 mA
12V models Output margin	R4	Open or connected over resistor to internal ground. Do not connect the margin pins in systems with several units.		3 VDC
48V models	R4	Open or connected to internal ground (+8 % $V_{o1}$ ) or $V_{sense+}$ (-8 % $V_{o1}$ ) Do not connect the margin pins in systems with several units.		60 VDC
12V models Synch. startup	R5	Open or connected to synch startup circuit, referenced to $V_{o1-}$ at the output connector		12V 3mA
48V models	R5	Open or connected to synch startup circuit, referenced to $V_{o1-}$ at the output connector		12V 2mA
$V_{o1+}$ output 12V models	P2, P4, P6, P8, P10, P12	Main output + pins		
$V_{o1-}$ output 12V models	P1, P3, P5, P7, P9, P11	Main output - pins		
$V_{o1+}$ output 48V models	P2, P4, P6	Main output + pins		
$V_{o1-}$ output 48V models	P1, P3, P5	Main output - pins		

**Mechanical Data (FNP1500/1800 12V Models)**

Mechanical Data (H, W, D)	5.6" (141.2mm) x 1.6" (40.5mm) x 11" (279.4mm)
---------------------------	--

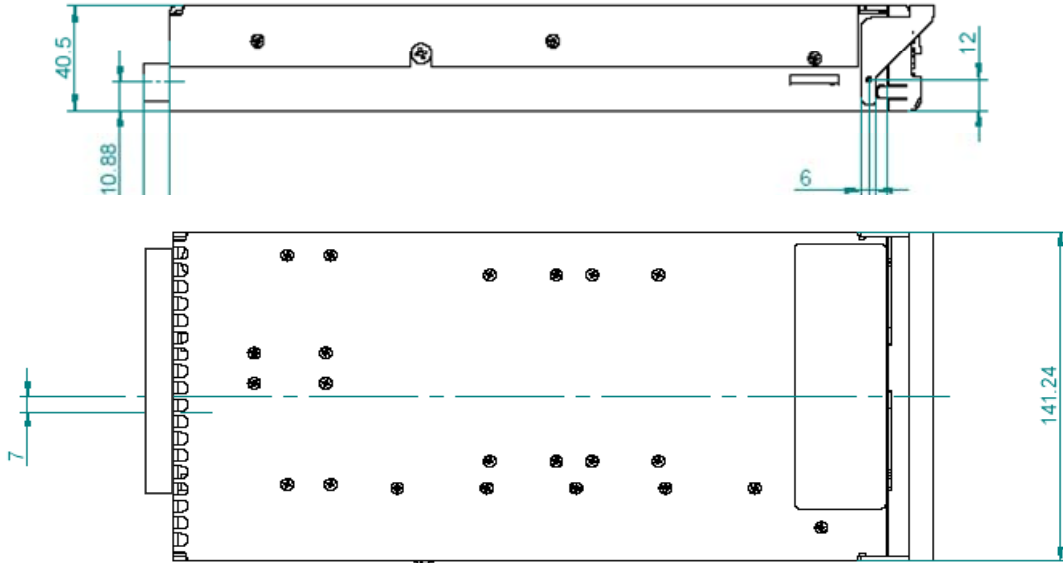

**FNP1500/1800 12V Model Output Connector Descriptions**

Rear View

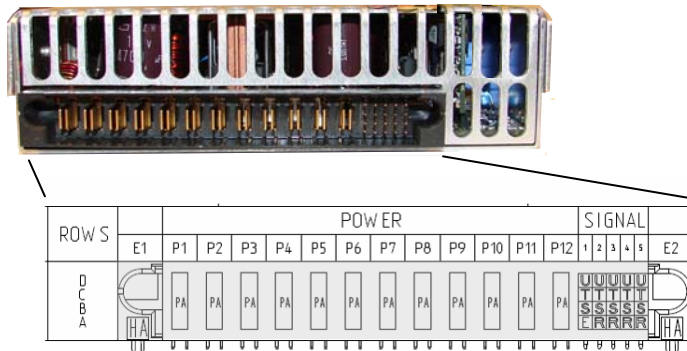

**Female Connector: FCI (51732-026 LF)**

**Mates with:**

90° output connector type:  Part No. FCI (manufacturer): 51762-11202000AA LF

180° output connector type:  Part No. FCI (manufacturer): 51742-11202000AA LF

IEC AC power cord with C19 connector VDE 16A: Interpower Components Ltd. 70009110250; Power-One Part No.: ZLA001-G  
IEC AC power cord with C19 connector UL 20A: Interpower Components Ltd. 70025110250

**Mechanical Data (FNP1500/1800 48V Models)**

Mechanical Data (H, W, D)	5.6" (141.2mm) x 1.6" (40.5mm) x 11" (279.4mm)
---------------------------	--

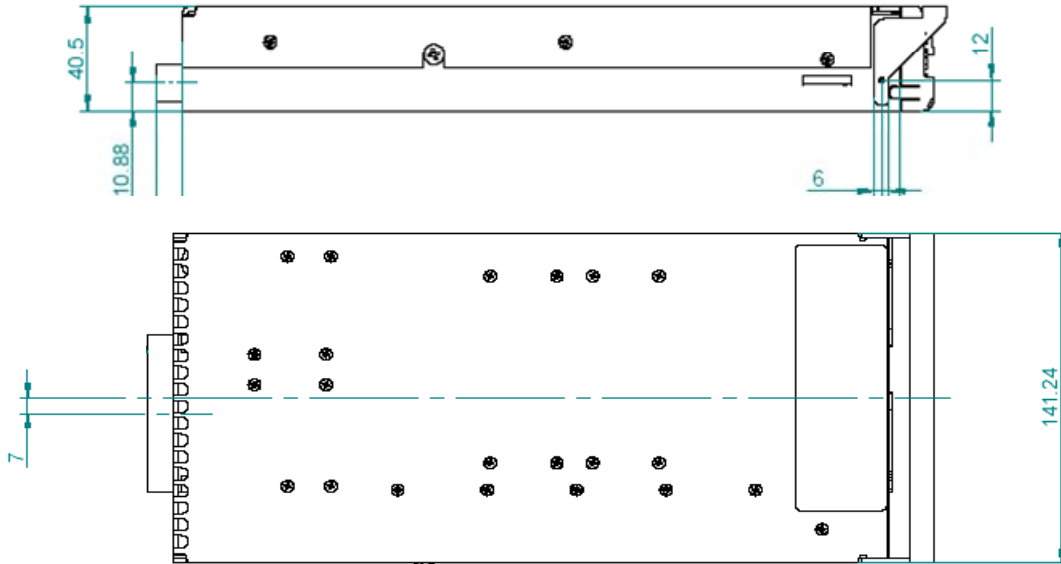

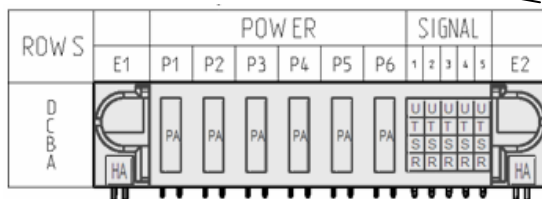

**FNP1500/1800 48V Model Output Connector Descriptions**

Rear View



Female Connector: FCI (51732-020 LF)

**Mates with:**

- 90° output connector type:  Part No. FCI (manufacturer): 51762-10602000AA LF; Power-One Part No.: ZES258-G
- 180° output connector type:  Part No. FCI (manufacturer): 51742-10602000AA LF

IEC AC power cord with C19 connector VDE 16A: Interpower Components Ltd. 70009110250; Power-One Part No.: ZLA001-G  
IEC AC power cord with C19 connector UL 20A: Interpower Components Ltd. 70025110250

**Paralleling Front-Ends:**

For parallel use in minimal configuration systems, only the inhibit pins must be shorted to logic GND. All other pins can be left open. The power supplies will share the output current automatically (droop current share).

For parallel applications without I<sup>2</sup>C bus, but the use of all other features, it is recommended to connect all logic GND's on a backplane together, to connect all V<sub>o2</sub> -, all V<sub>o2</sub> + and to leave the internal GND's open.

The sense wires can be left open or connected to a common load point, the synch-start pin can be left open or connected to a synch-start circuit, the inhibit pins can be connected together or used individually. All I<sup>2</sup>C signals (T1-T5, S1, and S2) can be left open.

Use of a small foil capacitor > 3µF directly at the power outputs of each unit is recommended in order to prevent voltage drops at the hot plug. For additional information on paralleling see the following Rack (Power Shelf) section.

**Racks**

**(FNR-3-12G and FNR-3-48G Power Shelves)**



Each rack (power shelf) is 1U high with backplane and designed for up to three front-end models in parallel or in n+1 operation. Each power shelf has:

- Massive copper bus bars for low-loss current distribution.
- Output terminals with two M4-screws on each power tab.
- Two fast-on contacts for system earthing.
- Address coding over five pole DIP switch on each unit, 37-pin D-Sub connector with I<sup>2</sup>C-lines, monitoring signals and support functions.
- Provides a start-up synchronization circuit and EMV filters.



**FNR-3-12G and FNR-3-48G Power Shelf Front View**

**Overall Mechanical Dimensions (FNR-3-12G and FNR-3-48G Power Shelves)**

FNR-3 Mechanical Data (W, H, D)	17.7" (449.6 mm) x 1.7" (43.1 mm) x 13" (330.2 mm)
---------------------------------	--