



ENGLISH

Datasheet

Stock No: 499-1944

RS Pro Manual Ball Valve Stainless Steel 1/2 in BSPP



Product Details

Stainless Steel Quarter-turn L- and T-Port Ball Valves

RS Pro Stainless Steel L and T Port Ball Valves used for controlling flow and are excellent choice for shut-off applications. These ball valves are durable and perform well even after long periods of time. Available in a variety of sizes.

Operating Temperature Range: -15 to +232 C

Pressure Rating WOG: 68 bar

Ball and Stem - AISI 316 Stainless Steel

Gland Nut, Handle, Stop-bolt and Lock Plate - AISI 304 Stainless Steel

Body Seal, Seal, Thrust Washer and Stem Pack Material - PTFE

Handle Washer-Bolt Material - ASTM A36

For "L" port valves see [RS 4991865](#), [RS 499-1871](#), [RS 499-1887](#), [RS 499-1893](#)

For "T" port valves see [RS 499-1938](#), [RS 499-1944](#), [RS 499-1950](#), [RS 499-1966](#)

Operating Temperature Range	to +232°C
Pressure Rating WOG	68 bar
Ball and Stem	AISI 316 Stainless Steel
Gland Nut, Handle, Stop-bolt and Lock Plate	AISI 304 Stainless Steel
Body Seal, Seal, Thrust Washer and Stem Pack Material	PTFE
Handle Washer-Bolt Material	ASTM A36

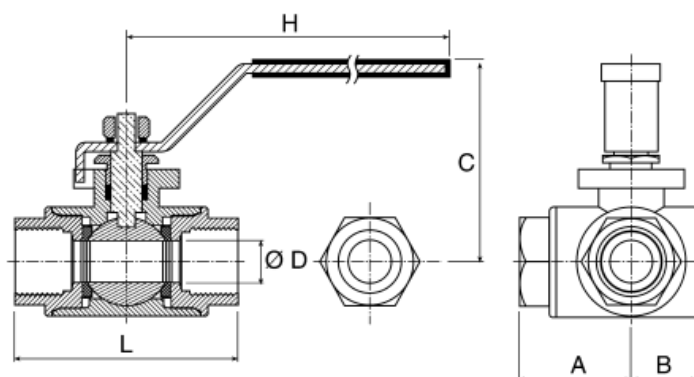

Port Type	1	2	3	4
L				
T				

Specifications:

Threaded Connection	1/2 in BSPP
Attachment Type	Threaded
Body Material	Stainless Steel
Thread Size	1/2in
Maximum Working Pressure	68 bar
Ball Material	Stainless Steel
Thread Standard	BSPP
Handle Material	Stainless Steel