



# VL18-4P2240V

V18V

PHOTOELECTRIC SENSORS

**SICK**  
Sensor Intelligence.



### Ordering information

Type	Part no.
VL18-4P2240V	6035497

Other models and accessories → [www.sick.com/V18V](http://www.sick.com/V18V)

Illustration may differ



### Detailed technical data

#### Features

<b>Sensor/ detection principle</b>	Photoelectric retro-reflective sensor, Dual lens
<b>Housing design (light emission)</b>	Cylindrical
<b>Housing length</b>	83 mm
<b>Thread diameter (housing)</b>	M18 x 1
<b>Optical axis</b>	Axial
<b>Sensing range max.</b>	0.035 m ... 4.5 m <sup>1)</sup>
<b>Sensing range</b>	0.035 m ... 4 m <sup>1)</sup>
<b>Type of light</b>	Visible red light
<b>Light source</b>	LED <sup>2)</sup>
<b>Light spot size (distance)</b>	Ø 60 mm (1 m)
<b>Angle of dispersion</b>	3°
<b>Wave length</b>	660 nm
<b>Adjustment</b>	Single teach-in button (Sensing range)Manual, via Touch-Teach-in
<b>Special applications</b>	Hygienic and washdown zones, Detecting transparent objects

<sup>1)</sup> Reflector PL80A.

<sup>2)</sup> Average service life: 100,000 h at T<sub>J</sub> = +25 °C.

## Mechanics/electronics

<b>Supply voltage</b>	10 V DC ... 30 V DC <sup>1)</sup>
<b>Ripple</b>	≤ 10 % <sup>2)</sup>
<b>Power consumption</b>	≤ 35 mA <sup>3)</sup>
<b>Switching output</b>	PNP
<b>Switching mode</b>	Light/dark switching
<b>Switching mode selector</b>	Selectable via L/D control cable
<b>Signal voltage PNP HIGH/LOW</b>	Approx. VS – 2.0 V / 0 V
<b>Output current I<sub>max.</sub></b>	≤ 100 mA
<b>Response time</b>	≤ 1 ms <sup>4)</sup>
<b>Switching frequency</b>	500 Hz <sup>5)</sup>
<b>Attenuation along light beam</b>	≥ 20 %
<b>Connection type</b>	Male connector M12, 4-pin <sup>6)</sup>
<b>Circuit protection</b>	A <sup>7)</sup> B <sup>8)</sup> C <sup>9)</sup> D <sup>10)</sup>
<b>Protection class</b>	III
<b>Weight</b>	120 g
<b>Housing material</b>	Stainless steel, Stainless steel V4A (1.4404, 316L)
<b>Optics material</b>	Plastic, Plan, PPS (Grilamid)
<b>Enclosure rating</b>	IP67, IP68, IP69K <sup>11)</sup>
<b>Special feature</b>	Detecting transparent objects
<b>Ambient operating temperature</b>	–25 °C ... +80 °C <sup>12)</sup>
<b>Ambient storage temperature</b>	–40 °C ... +80 °C
<b>UL File No.</b>	FDA, UL No. NRKH.E181493 & cUL No. NRKH7.E181493

<sup>1)</sup> Limit values.

<sup>2)</sup> May not exceed or fall below U<sub>v</sub> tolerances.

<sup>3)</sup> Without load, at VS 30 V DC.

<sup>4)</sup> Signal transit time with resistive load.

<sup>5)</sup> With light/dark ratio 1:1.

<sup>6)</sup> With gold plated contact pins, PPS with FDA certificate.

<sup>7)</sup> A = V<sub>S</sub> connections reverse-polarity protected.

<sup>8)</sup> B = interference suppression.

<sup>9)</sup> D = outputs overcurrent and short-circuit protected.

<sup>10)</sup> D = inputs and output reverse-polarity protected.

<sup>11)</sup> With correct mounted IP69K connector.

<sup>12)</sup> +100 °C at max 15 minutes.

## Classifications

<b>ECl@ss 5.0</b>	27270902
<b>ECl@ss 5.1.4</b>	27270902
<b>ECl@ss 6.0</b>	27270902
<b>ECl@ss 6.2</b>	27270902
<b>ECl@ss 7.0</b>	27270902

<b>ECl@ss 8.0</b>	27270902
<b>ECl@ss 8.1</b>	27270902
<b>ECl@ss 9.0</b>	27270902
<b>ETIM 5.0</b>	EC002717
<b>ETIM 6.0</b>	EC002717
<b>UNSPSC 16.0901</b>	39121528

### Adjustments possible

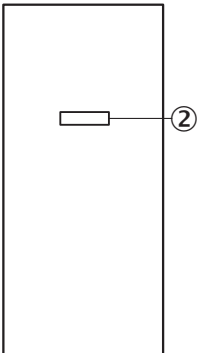

② Sensing range adjustment: Touch-Teach-In

### Connection diagram

cd-087

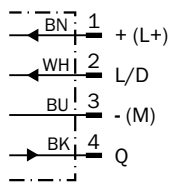

### Characteristic curve

VL18V, clear material detection

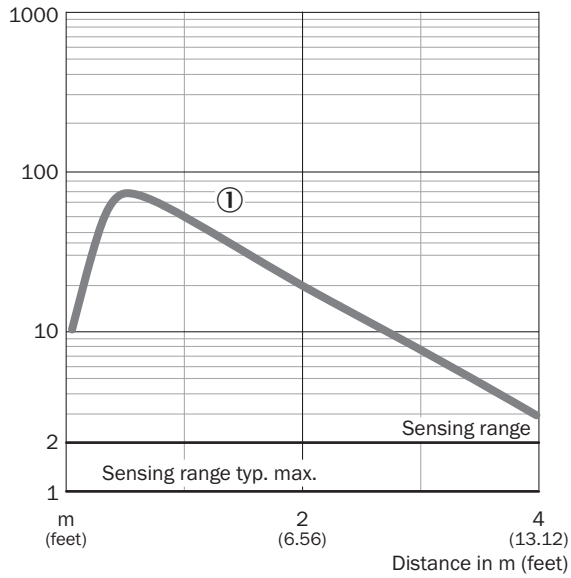

① Reflector PL80A

### Sensing range diagram

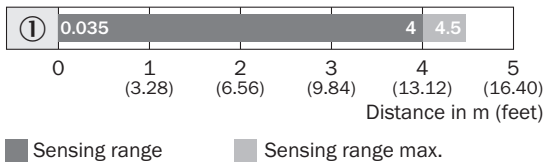

| 1 | PL80A

**Dimensional drawing** (Dimensions in mm (inch))

VTF18V, VTE18V

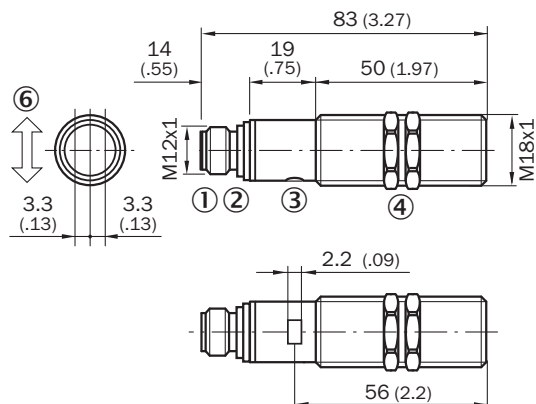





- ① M12 male device connector, 4-pin
- ② Sensing range adjustment: Touch-Teach-In
- ③ Status indicator LED, green: signaling Touch-Teach-in
- ④ Yellow LED indicator: lights continuously: Reception signal > reserve factor 2- blinks: Reception signal < reserve factor 2 but > switching threshold 1
- ⑤ Fastening nuts (2 x); width across 24, stainless steel

**Recommended accessories**

Other models and accessories → [www.sick.com/V18V](http://www.sick.com/V18V)

	Brief description	Type	Part no.
<b>Universal bar clamp systems</b>			
	Plate N06N for universal clamp bracket, M18, Stainless steel 1.4571 (sheet), Stainless steel 1.4408 (clamp), Universal clamp (5322627), mounting hardware	BEF-KHS-N06N	2051622
<b>Mounting brackets and plates</b>			
	Mounting plate for M18 sensors, stainless steel, without mounting hardware	BEF-WG-M18N	5320948
	Mounting bracket for M18 sensors, stainless steel, without mounting hardware	BEF-WN-M18N	5320947
<b>Terminal and alignment brackets</b>			
	Mounting bracket with ball-and-socket, Plastic, mounting hardware included	BEF-WN-M18-ST02	5312973
	Clamping block for round sensors M18, without fixed stop, plastic (PA12), glass-fiber reinforced, mounting hardware included	BEF-KH-M18	2051481
	Clamping block for round sensors M18, with fixed stop, plastic (PA12), glass-fiber reinforced, mounting hardware included	BEF-KHF-M18	2051482
	Mounting ring, stainless steel, without mounting hardware	BEF-WN-MH15-2V	4053358

	Brief description	Type	Part no.
<b>Reflectors</b>			
	Rectangular, screw connection, 80 mm x 80 mm, PMMA/ABS, Screw-on, 2 hole mounting	PL80A	1003865
	Self-adhesive	REF-IRF-56	5314244
	Chemically resistant, screw connection, 47 mm x 47 mm, Plastic, Screw-on, 2 hole mounting	P250 CHEM	5321097
	Fine triple reflector, chemically resistant, screw connection, 18 mm x 18 mm, Plastic, Screw-on, 2 hole mounting	PL10F CHEM	5321636
	Chemically resistant, screw connection, suitable for laser sensors, 16 mm x 38 mm, Plastic, Screw-on, 2 hole mounting	PL20F-CHEM	5326089
	Anti-fog to prevent moisture condensation on the reflective surface, screw connection, 56 mm x 37 mm, PMMA/ABS, Screw-on, 2 hole mounting	PL40A Antifog	5322011
	Rectangular, M3 screw connection, countersunk screw head, chemically resistant, 56 mm x 37 mm, Plastic, Screw-on, 2 hole mounting	PL40B-CHEM	5326088
	Stainless steel reflector, hygienic design, chemically resistant, enclosure rating IP69K, D12 adapter shaft, PMMA front screens, 25 mm x 25 mm, Stainless steel V4A (1.4404, 316L), D12-adapter shaft	PLH25-D12	2063404
	Stainless steel reflector, hygienic design, chemically resistant, Enclosure rating IP 69K, M12-adapter thread, PMMA front screens, 25 mm x 25 mm, Stainless steel V4A (1.4404, 316L), M12-adapter thread	PLH25-M12	2063403
	Stainless steel reflector, washdown design, chemically resistant, IP 69K enclosure rating, screw connection, PMMA front screens, 14 mm x 14 mm, Stainless steel V4A (1.4404, 316L), Screw-on, 2 hole mounting	PLV14-A	2063405

## SICK AT A GLANCE

SICK is one of the leading manufacturers of intelligent sensors and sensor solutions for industrial applications. A unique range of products and services creates the perfect basis for controlling processes securely and efficiently, protecting individuals from accidents and preventing damage to the environment.

We have extensive experience in a wide range of industries and understand their processes and requirements. With intelligent sensors, we can deliver exactly what our customers need. In application centers in Europe, Asia and North America, system solutions are tested and optimized in accordance with customer specifications. All this makes us a reliable supplier and development partner.

Comprehensive services complete our offering: SICK LifeTime Services provide support throughout the machine life cycle and ensure safety and productivity.

For us, that is “Sensor Intelligence.”

## WORLDWIDE PRESENCE:

Contacts and other locations –[www.sick.com](http://www.sick.com)