



ENGLISH

Datasheet

DC Axial Fan, 40 x 40 x 20mm, 15.3m/h, 2.2W, 24 V dc (OD4020 Series)

RS Stock number [541-5160](#)



RS Part Number	Orion Part Number	Speed (RPM)	Airflow (CFM)	Noise (db)	Volts (DC)	Voltage Range	Current (Amps)	Lead Type
5414915	OD4020-12HB	7800	9	32	12	7~14	0.10	Wire
5414909	OD4020-12MB	6900	7.8	28.5	12	7~15	0.08	Wire
5414892	OD4020-12LB	6200	7	25	12	7~16	0.07	Wire
5415160	OD4020-24HB	7800	9	32	24	10~27	0.09	Wire
5415154	OD4020-24MB	6900	7.8	28.5	24	10~27	0.07	Wire
5415148	OD4020-24LB	6200	7	25	24	10~27	0.06	Wire

Frame and Impeller

PBT, UL94V-0 Thermoplastic

Available Options

Tachometer

Locked Rotor Alarm

Finger Guard: G40-2

Plastic Guard: G40P

Filter Kit: GRM40-30, GRM40-45

Drawing(mm):

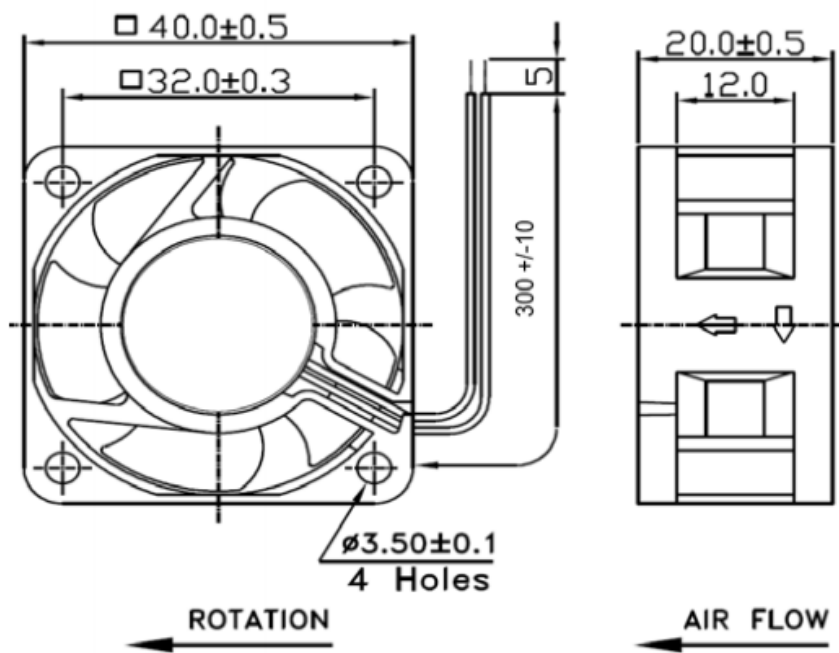

*Drawing for Dimensional Reference Only

MOTOR

Brushless DC, polarity protected, locked rotor protected (current limited), auto restart

INSULATION RESISTANCE

Min. 10 M ohms at 500VDC

LIFE EXPECTANCY (L10)

Ball Bearing 60,000 Hours

Operating Temperature

-10C ~ +70C

Safety Approvals

UL/CUL, TUV, CE