



ENGLISH

Datasheet

DC Axial Fan, 120 x 120 x 25mm, 144.5m/h, 5.8W, 24 V dc (OD1225 Series)

RS Stock number [668-8858](#)



RS Order Number	6688849	6688858
Model Number	OD1225-12HSS	OD1225-24HSS
Part Number	122143001	122243001
Nominal Voltage	12 VDC	24 VDC
Nominal Current	0.44	0.24A
Rated Power	5.3 W	5.8 W
Rated Speed (RPM)	2200	2200
Airflow (CFM)	85	85
Noise Level (dB)	39	39
Max. Static Pressure	0.14" H2O	0.14" H2O

Drawing(mm):

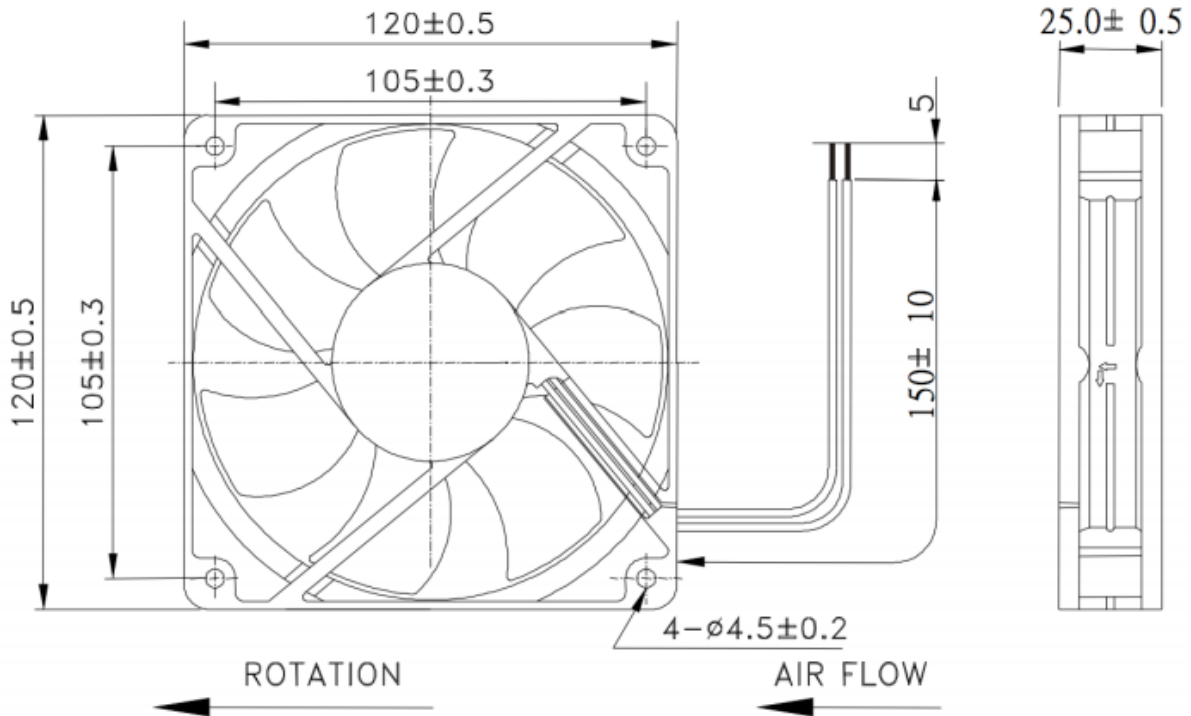

Specifications:

Frame & Impeller:	PBT, UL94V-O plastic
Connection:	2x Lead wires 24AWG
Motor:	Brushless DC, auto restart, polarity protected
Bearing System:	Sealed sleeve
Insulation Resistance:	10M ohm between leadwire and frame (500VDC)
Dielectric Strength:	1 second at 500 VAC, max leakage – 500 microAmp
Operating Temp:	-10°C ~ 70°C
Life Expectancy:	50,000 hours