

Datasheet

RS 107 Series 2.77mm Pitch 37 Way Right Angle PCB D-sub Connector, Socket, Solder Termination, with 4-40 UNC Screwlocks

RS Stock number 811-7137

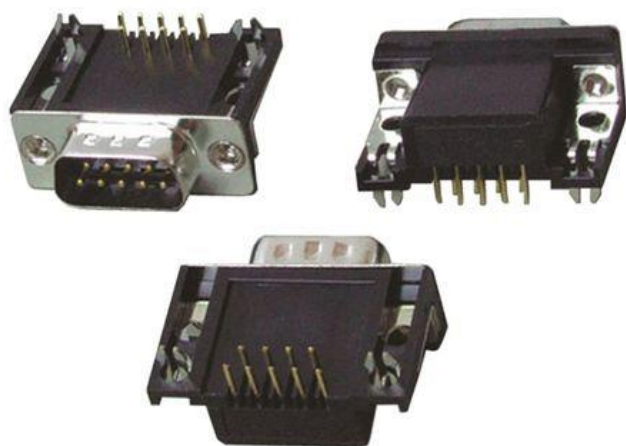

Dimensions: (mm)

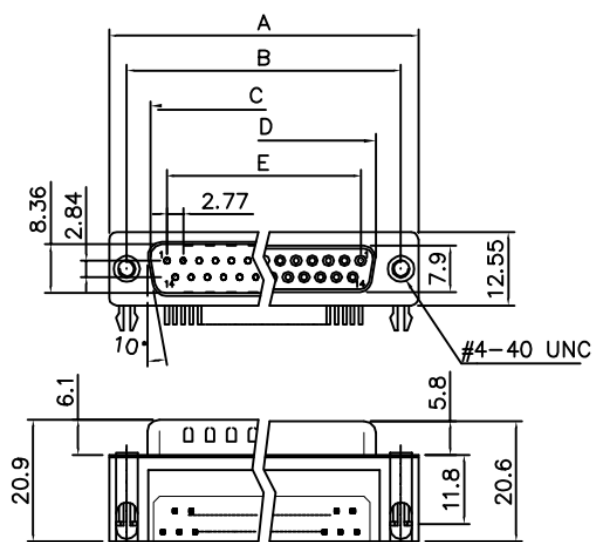

RoHS COMPLIANT

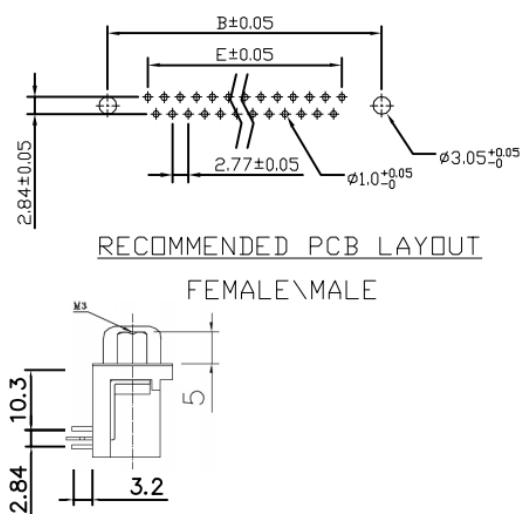



Product Specification

Material

Insulator : Glass-Filled Thermoplastic PBT, UL94V-0

Contact : Brass

Shell : Steel, 100u" Tin Over 50u" min Copper

Clinch Nut : Brass, Nickel Plated.

Boardlock : Brass, Tin Plated.

Screwlock : Brass, Nickel Plated.

Electrical

Contact Resistance : 20 milliohms
Max at 1 AMP DC.

Insulation Resistance : 1000
megohms at 500 VDC

Dielectric Withstanding Voltage :
1000 VAC/rms 60Hz for 1 minute

Current Rating : 3 AMP

Volatge Rating : 250 VAC/rms 60Hz