

## A True 150nA I<sub>Q</sub>, 0.9-3.6V<sub>IN</sub>, Selectable 1.8-5V<sub>OUT</sub> Instant-On™ Boost Converter

### REVISION NOTE

The current revision for the TS3310 Demo Board displays the identifier TS3310-10 on the bottom of the evaluation board as depicted in Figure 2. If the TS3310-10 identifier is not printed on the bottom side of the evaluation board, please contact Silicon Labs for support at:

<https://www.silabs.com/support/pages/contacttechnicalsupport.aspx>

### COMPONENT LIST

DESIGNATION	QTY	DESCRIPTION
L1	1	10μH ±10% Wire-wound (Unshielded, 1210) CBC3225T100KR
C6	1	220pF ±5% capacitor (COG, 50V, 0805) CL21C221JBANFNC
C2, C3	2	10μF ±10% capacitor (X5R, 16V, 0805) EMK212BJ106KG-T
C4, C5	2	0.1μF ±10% capacitor (X7R, 16V, 0402) EMK105B7104KV-F
C1	1	0.1μF ±10% capacitor (X7R, 50V, 0805) 08055C104KAT2A
R1	1	3.3MΩ ± 1% (0805) CRCW08053M30FKEA
U1	1	TS3310
IN, STORE, OUT, PG, GND (4)	8	Test points
S0, S1, S2, OUT_ON	4	Jumper

### FEATURES

- Input Voltage Range: 0.9V- 3.6V
- Jumper Selectable Output Voltages: 1.8V, 2.1V, 2.5V, 2.85V, 3V, 3.3V, 4.1V, and 5V
- OUT Enable/Disable Jumper
- 10μH Inductor, 900mA I<sub>SAT</sub> (Taiyo Yuden: CBC3225T100KR)

### DESCRIPTION

The TS3310 is a low power boost converter with an industry leading low quiescent current of 150nA, enabling ultra long battery life in systems running from a variety of battery sources. The TS3310 steps up input voltages from 0.9V to 3.6V to eight selectable output voltages ranging from 1.8V to 5.0V. The TS3310 includes two output options, one being an always-on storage output while the additional output is an output load switch that is designed to burst-on loads in a low duty cycle manner.

The TS3310 output voltage can be set via jumpers S0, S1, and S2. Both the STORE and OUT output can be monitored along with the power good output VGOOD. Jumper OUT\_ON is available to disable or enable the OUT output.

Product data sheet and additional documentation can be found at [www.silabs.com](http://www.silabs.com).

### ORDERING INFORMATION

Order Number	Description
TS3310DB	TS3310 Demo Board 10μH Operation



Figure 1. TS3310DB Top View

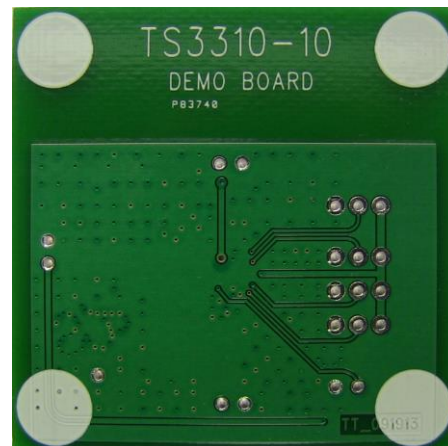

Figure 2. TS3310DB Bottom View

## DESCRIPTION

The TS3310DB is configured for 10µH inductor operation and includes a 220pF C<sub>LSW</sub> capacitor which is connected from the LSW pin to PCB ground, otherwise labeled C6 on the demo board.

The maximum available output current for the TS3310 is a function of the inductor value and the average input current. The average input current will vary according to the load. When the output current is at its maximum, the averaged input current is at a maximum. The maximum averaged input current is defined by Equation 1.

$$I_{IN(AVG,MAX)} = \frac{I_{pk}}{2} = \frac{1\mu s \cdot V}{L}$$

**Equation 1.** Maximum Average Input Current Calculation

The expected maximum STORE output current is defined by Equation 2.

$$I_{STORE(MAX)} = \frac{V_{IN}}{V_{OUT}} \times I_{IN(AVG,MAX)} \times \text{Efficiency}$$

**Equation 2.** Expected Maximum STORE Output Current Calculation

Table 1 lists some example inductor values and the corresponding expected maximum output load current available for the TS3310, assuming an 85% efficiency.

L	C <sub>LSW</sub>	I <sub>STORE(MAX)</sub>
10µH	220pF	35mA
22µH	100pF	15mA
33µH	---	10mA
100µH	---	3mA

**Table 1.** Expected Maximum STORE Output Current per Inductor Value

The TS3310 demo board is configured for 3V output by default. With a 1.2V input voltage, the TS3310DB which is configured for 10µH operation can supply a maximum STORE output current of approximately 35mA.

The TS3310 demo board provides test points to monitor the output voltage STORE and OUT. The power good pin, VGOOD, is pulled to the STORE output by a 3.3MΩ pull-up resistor R1 and can be monitored via test point PG. To enable or disable the OUT output voltage, a jumper for the OUT\_ON pin is available. The STORE and OUT output voltage can be set via jumpers S2, S1, and S0.

Table 2 displays the S2, S1, and S0 combinations along with the corresponding output voltage. For 5V output operation, a minimum input voltage of 2V is required. The TS3310 demo board circuit in its default configuration, with a 3V output voltage, is displayed in Figure 3.

S2	S1	S0	STORE (V)	OUT_ON	OUT (V)
0	0	0	1.8	HIGH	Equal to STORE (V)
0	0	1	2.5		
0	1	0	3.3		
0	1	1	5		
1	0	0	2.1		
1	0	1	2.85		
1	1	0	3		
1	1	1	4.1		
Same as Above			Same as Above	LOW	0V

**Table 2.** STORE and OUT Voltage Settings

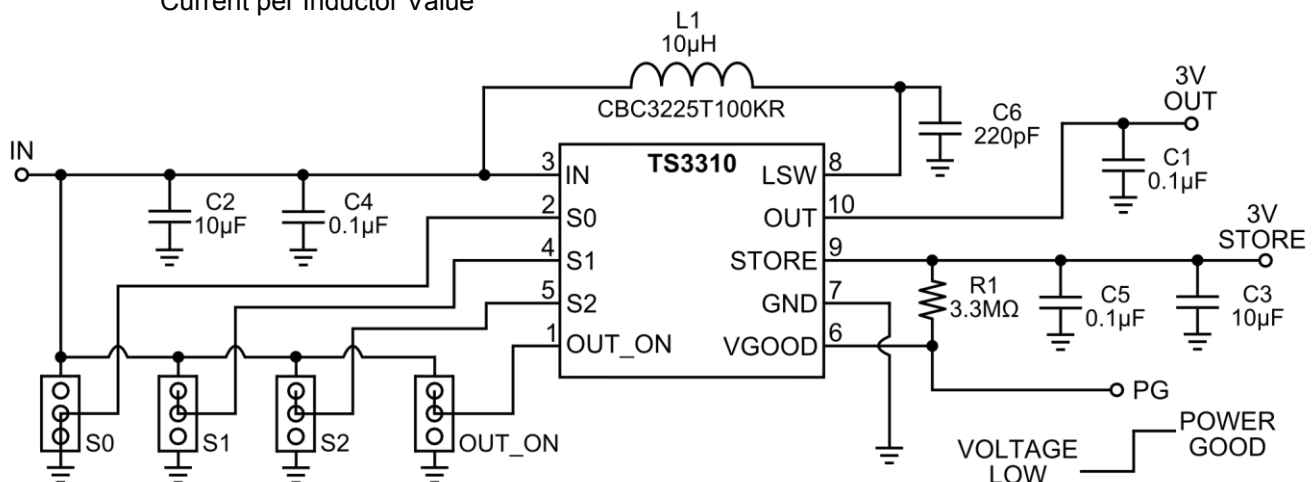

**Figure 3.** TS3310DB Circuit Schematic

## TS3310DB QUICK START PROCEDURE

### Required Equipment

- TS3310DB
- 1.2V Battery or 1.2V Power Supply
- Three Digital Multimeters
- One Oscilloscope

To evaluate the TS3310 the following steps are to be performed:

- 1) Connect the battery or power supply's positive terminal to the test point labeled IN. Connect the negative terminal of the battery or power supply to the test point labeled GND.
- 2) To monitor the STORE output voltage, connect the positive terminal of the voltmeter to the test point labeled STORE. Connect the negative terminal of the voltmeter to the test point labeled GND. The output voltage should be approximately 3V.
- 3) To monitor the STORE output voltage ripple, connect an Oscilloscope probe to the test point labeled STORE.
- 4) To monitor the OUT output voltage, connect the positive terminal of the second voltmeter to the test point labeled OUT. Connect the negative terminal of the voltmeter to the test point labeled GND. The output voltage should be approximately 3V. To disable the OUT output voltage, set jumper OUT\_ON to LOW.
- 5) To monitor the open-drain VGOOD output, connect an Oscilloscope Probe to the test point labeled PG. The VGOOD output signal assumes a high impedance once the STORE output voltage is greater than 90% of the target output voltage, which is 2.7V for the 3V default configuration.
- 6) The maximum STORE output current for the TS3310 programmed for 3V output operation with a 1.2V input voltage can be measured. To evaluate the maximum STORE output current for the TS3310-10DB, configured for 10 $\mu$ H operation, connect a 75 $\Omega$  resistor from STORE to GND.
- 7) To measure the STORE output current, connect an Ammeter in series between the 75 $\Omega$  Resistor and GND.
- 8) To evaluate the TS3310 with a different output voltage setting, reconfigure the provided jumpers S0-S2. Please refer to Table 2 for the available output voltages and their corresponding S0-S2 jumper configuration. Note that the input voltage range is 0.9V to 3.6V. For 5V output operation, a minimum input voltage of 2V is required.

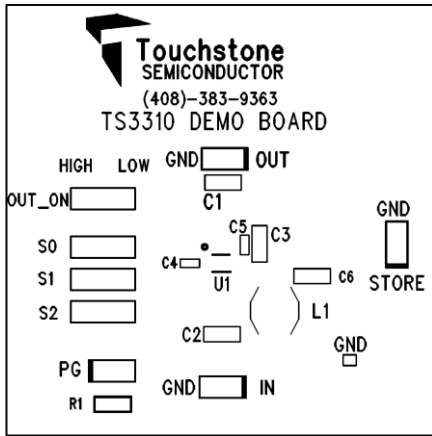

Figure 4. TS3310DB Top Layer #1

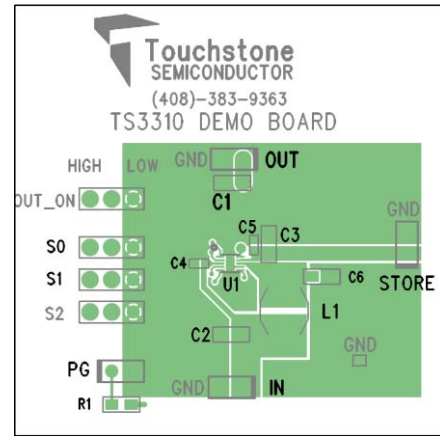

Figure 5. TS3310DB Top Layer #2

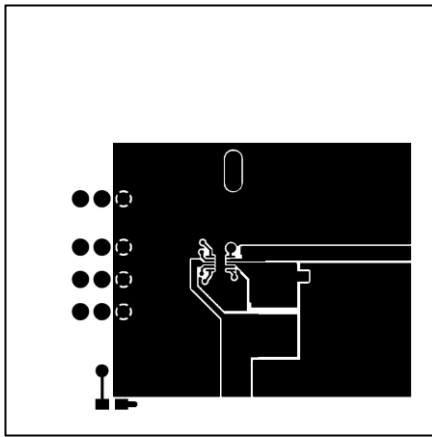

Figure 6. TS3310DB Top Layer #3

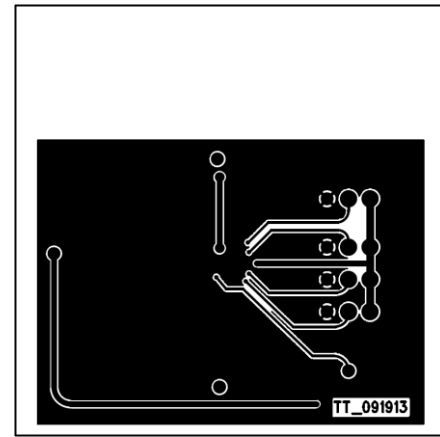

Figure 7. TS3310DB Bottom Layer #1

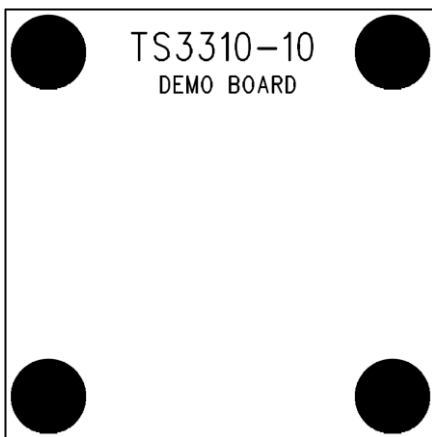

Figure 8. TS3310DB Bottom Layer #2

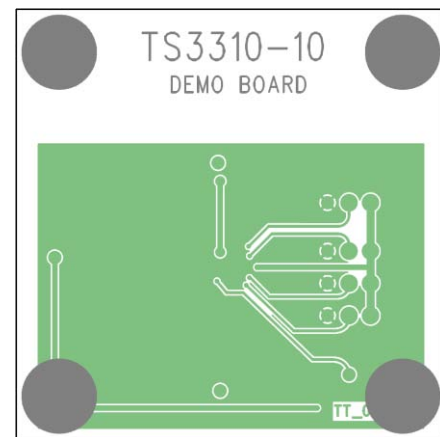

Figure 9. TS3310DB Bottom Layer #3