



ZENITH P Series

Increased Safety Enclosures
and Terminal Boxes
for Applications in Hazardous Environments



ZENITH P Series

Increased Safety Ex e - Enclosures / Terminal Boxes

> SCAME PARRE S.p.A.



Established in 1963, today SCAME employs 700 people to run 7 production sites covering a total area of 62,500m². Modern equipment, robotized assembly work and meticulous quality control guarantee a product that is both reliable and technologically advanced.

SCAME produces over 10,000 products. These include a wide range of components and systems for electrical installations, suitable for industrial and domestic applications (switchgears, enclosures, plugs and sockets, distribution assemblies and industrial adaptors). A strong confidence in human resources and inclination for creativity guide the company to pursue innovation and to propose new products to the market, always featuring beautiful design and full performance reliability.

The success of the company has been built on the dedication to total quality control, market leading design, rigorous testing and approvals from certifying authorities. The new challenge is to become a leading supplier of high quality electrical enclosures and junction boxes suitable for hazardous area markets.

The ZENITH enclosures and terminal boxes by Scame are sold in the international market, mainly for the chemical and petrochemical industries and for the food industries.

Extensive services such as finishing, tooling and testing of the enclosure systems are provided to satisfy the customer requirements.



Isolator Series



Eureka Series



Advance Series



Mbox Series



Domino Series

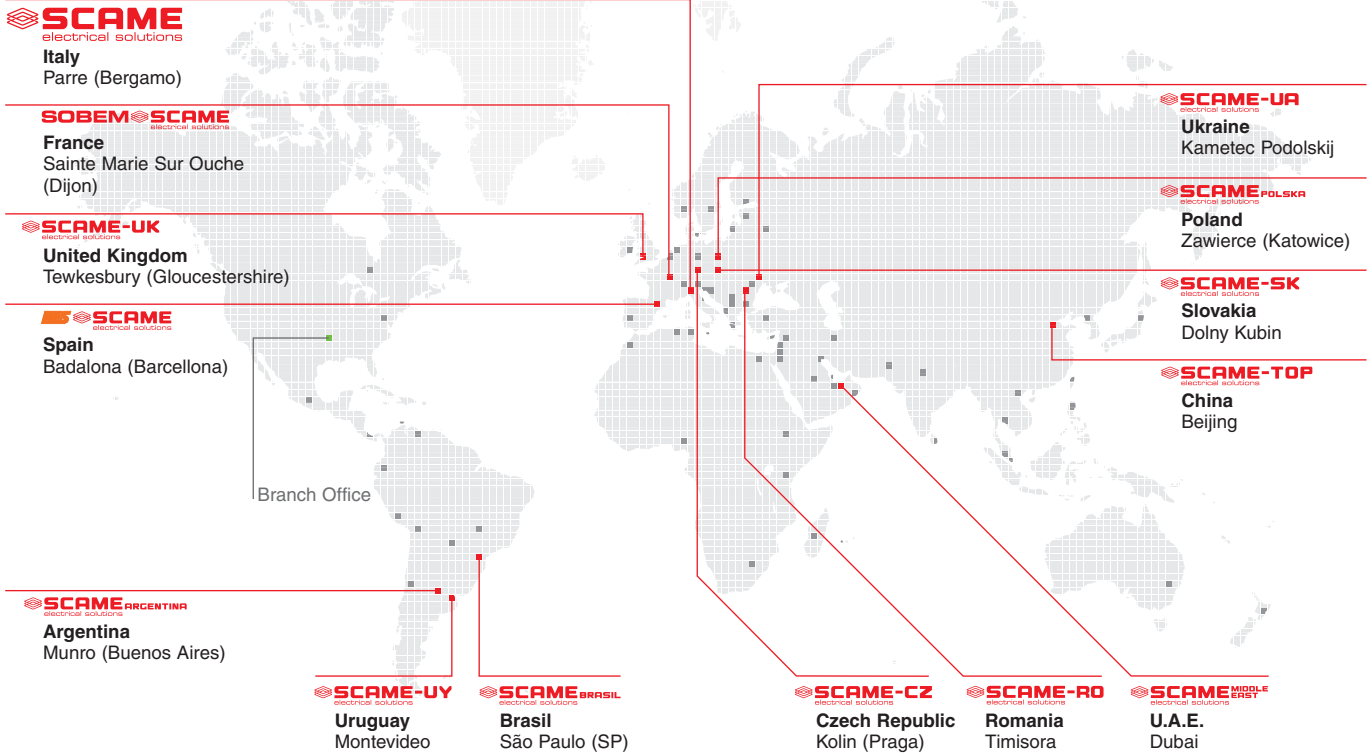

> WORLDWIDE

With a long manufacturing expertise, SCAME exports the Italian know-how worldwide, consolidating business relations with over 100 countries and building global partnerships in five continents.

> AFTER-SALES SERVICE

The sales organisation includes a wide network of agents and dealers which ensures the best service for the final customers. The international sales organisation operates in close contact with the head office, simplifying the flow of business (orders, consignments), and offering a reliable and flexible technical service. The dealers and agents can quickly and effectively meet any market requirements: custom-built articles for specific applications, detailed instructions for the installation and use of the products, efficient and fast problem solving instructions are key factors of our sales activity.

> TOTAL QUALITY CERTIFICATION

Within its "Total Quality" program, SCAME's quality system has long been recognised as fully compliant with ISO 9001 and ISO 14000 standards, certified through the assignment of the CSQ/IQNet mark. This official acknowledgment guarantees the quality of the manufacturing practise, and is granted because the company complies with strict standards in terms of the design, production and marketing of all its products.

In addition, SCAME adopts a certified quality system in conformity with the ATEX directive, where special requirements are indispensable for the manufacturers of electrical equipment to be used in a potentially explosive atmosphere due to the presence of flammable gases, vapours, fumes and combustible dusts.



ZENITH P Series

Group II - Category 2

Ex e Terminal Box

Zone 1-2 Zone 21-22



> GENERAL DESCRIPTION

The ZENITH P range comprises 15 sizes of enclosure manufactured in GRP glass reinforced polyester with 4 mm thickness. Polyester gives excellent mechanical strength and life expectancy: this material is highly resistant to contamination, it is absolutely corrosion-proof and is suitable for LSOH (low smoke zero halogen) applications. The range is carbon loaded which helps to reduce the surface resistance of the material and consequently removes the risk of ignition sources through static induced sparking resistivity. The mounting holes are contained within the profile of the enclosure, but are outside the seal. The wall thickness is sufficient to allow entry holes to be machined in the walls of the enclosure and it provides a very good alternative to aluminium, stainless steel or cast iron.

> APPLICATION

These enclosures may be supplied with terminals fitted or as an empty certified component. If supplied as the latter, then final certification by the customer after fitting additional equipment, must be obtained. The ZENITH P range offers safe protection in various applications including both industrial and hazardous area where extremely unfavourable conditions are present. They are ideal for a wide variety of uses such as OEM applications, fire protection systems, tunnel wiring, lighting, power and instrument junction boxes.

> CERTIFICATIONS

The products have passed laboratory tests and obtained the safety certification by approved ATEX certification bodies. Scame guarantees that the enclosure systems have been correctly manufactured and are compliant with safety standards. The correct use of the enclosure systems for their intended duty is essential for safeguarding the type of protection.

> REFERENCE STANDARDS

IEC 60079-0 / EN 60079-0
Electrical apparatus
for explosive gas atmospheres

IEC 61241-0 / EN 61241-0
Electrical apparatus for use
in the presence of combustible dust

IEC 60079-7/EN 60079-7
Electrical apparatus for explosive gas atmospheres
Part 7: increased safety "e"

The ZENITH P increased safety enclosure range meets the requirements of IEC/EN 60079-0, 60079-7, 60079-11 (Zone 1 and 2) or those of IEC/EN 61241-0, 61241-1 (Zone 21 and 22). They are developed, manufactured and tested in accordance with state-of-the-art engineering practice and ISO 9001 and ISO 14000.

> SPECIFICATIONS

Atex Code:	Ex II 2GD
Ex Protection type:	Ex e II Ex ia IIC Ex tD A21 IP6X T85°C
Certificates:	
- Empty Enclosure	Sira 08ATEX304IU IECEx SIR 08.0013U
- Terminal Box	Sira 08ATEX3042 IECEx SIR 08.0014
Operating Temperature Range:	-60°C to +75°C (limits)
Temperature Class and Ambient	
- Standard	Ambient 40°C and T6 Class
- Optional	Ambient 60°C and T6 Class Ambient 60°C and T5 Class Ambient 75°C and T4 Class
Degree of Protection:	IP66
Material:	<ul style="list-style-type: none"> • Glass Reinforced Polyester (SMC) – 4 mm thickness • Carbon Loaded for Anti-Static protection • UV resistant according to ISO 4892-2 • Halogen Free and formulated RoHs directive • Absolutely corrosion-proof • Seawater-proof
Surface Resistance:	Antistatic properties: < 10⁹ Ω The enclosures do not present a hazard from static electricity
Finish:	Natural Black RAL 9005
Impact Resistance:	The enclosures are designed to withstand an impact of 7 J, and to be used in normal conditions of vibration

> ZENITH P SERIES

Code	Enclosure size	EXTERNAL			INTERNAL			FIXINGS			WEIGHT
		H	W	D	h	w	d	H+	W+	Holes	Weight
644.0100	75x80x55	75	80	55	58	48	46	45	68	Ø 4,5	243
644.0200	75x80x75	75	80	75	58	48	66	45	68	Ø 4,5	297
644.0110	75x110x55	75	110	55	58	78	46	45	98	Ø 4,5	303
644.0210	75x110x75	75	110	75	58	78	66	45	98	Ø 4,5	368
644.0120	75x160x55	75	160	55	58	128	46	45	148	Ø 4,5	400
644.0220	75x160x75	75	160	75	58	128	66	45	148	Ø 4,5	484
644.0130	75x190x55	75	190	55	58	158	46	45	178	Ø 4,5	458
644.0230	75x190x75	75	190	75	58	158	66	45	178	Ø 4,5	552
644.0140	75x230x55	75	230	55	58	198	46	39	218	Ø 4,5	553
644.0240	75x230x75	75	230	75	58	198	66	39	218	Ø 4,5	670
644.0350	120x220x90	120	220	90	102	190	80	82	204	Ø 6,5	1.071
644.0360	160x160x90	160	160	90	142	112	80	110	140	Ø 6,5	1.159
644.0370	160x260x90	160	260	90	142	212	80	110	240	Ø 6,5	1.578
644.0380(*)	160x360x90	160	360	90	142	312	80	110	340	Ø 6,5	1.994
644.0390(*)	160x560x90	160	560	90	142	512	80	110	540	Ø 6,5	2.929

(*) Under development

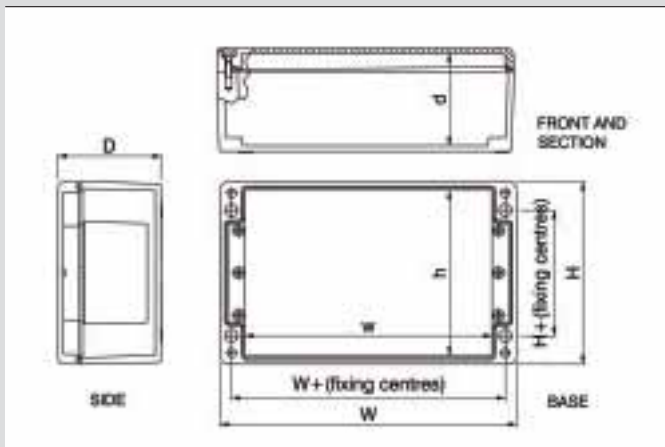

> LID FIXING SCREWS

Corrosion resistant Stainless Steel (complete with retaining washer) for flat blade and PH screw head driver. Mounting holes located outside of the sealed area.



> WEATHERPROOF

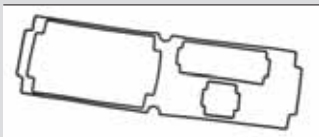

Lid gasket made of silicone rubber, moulded in one piece. Optimum performance at low and high temperature extremes.

> CERTIFICATION LABEL

Certified self adhesive label. Stainless steel bonded plate (on request).

> INCLUDED IN DELIVERY



- Empty Enclosure:
Enclosure with silicone seal and accessories not assembled.
- Terminal Box:
Pre-drilled Enclosure system – depending on version either with DIN rails and accessories and terminals (assembled). Cable glands can be supplied on request.











> TERMINAL MOUNTING



Terminals shall be rail or internal plate mounted. DIN rail (TS 15, TS 35): 1 row. Certified terminal manufacturer and type have cross section 1.5mm² to 35mm². Our assembly service can supply these enclosures pre-assembled with terminals and cable glands according to customer's requirements.

ZENITH P Series

> RANGE AND ACCESSORIES

H	W		ENCLOSURE			EARTH CONTINUITY PLATE		
			55	75	90	55	75	90
75	80		644.0100	644.0200	-	644.A0100	644.A0200	-
	110		644.0110	644.0210	-	644.A0110	644.A0210	-
	160		644.0120	644.0220	-	644.A0120	644.A0220	-
	190		644.0130	644.0230	-	644.A0130	644.A0230	-
	230		644.0140	644.0240	-	644.A0140	644.A0240	-
120	220		-	-	644.0350	-	-	644.A0350
	160		-	-	644.0360	-	-	644.A0360
160	260		-	-	644.0370	-	-	644.A0370
	360		-	-	644.0380	-	-	644.A0380
	560		-	-	644.0390	-	-	644.A0390

> YOU CAN FIND US ON THE INTERNET www.scame.com/atex



> QUALITY AND SERVICE



We will do our best to give complete and continuous up-to-date information about innovations, new products, trade fairs and applications relevant to our products. Also available is a complete library of literature applicable to our product offering: Technical data sheets, certificates and instructions all available on-line.

Scame manufactures enclosure systems and, as a service provider, we can offer much more than just standards out of a catalogue. We are solution oriented and therefore ready to offer individual products or completely assembled systems based on your requirements.







Empty Enclosure



Terminal Box



Pre-drilled Enclosure

INTERNAL MOUNTING PLATE	EXTERNAL MOUNTING BRACKETS	EXTERNAL MOUNTING VERTICAL FEET	EARTH STUD (*)	EXTERNAL HINGES (*)
				
55-75-90	55-75-90	55-75-90	55-75-90	55-75-90
644.B00				
644.B10				
644.B20	644.C075	644.D075		
644.B30				
644.B40				
644.B50	644.C120	644.D120	644.E650	644.F001
644.B60				
644.B70				
644.B80	644.C160	644.D160		
644.B90				

> ACCESSORIES

- A) Earth Continuity Plate (ECP) made of zinc plated steel. Also available in brass or copper
- B) Component Mounting Plate made of zinc plated steel
- C) External Mounting Brackets (4 sets) made of stainless steel AISI 316
- D) External Mounting Vertical Feet (2 sets) made of stainless steel AISI 316
- E) Earth Stud made of brass. Also available in stainless steel AISI 316(*)
- F) External Hinges (2 sets) made of termoplastic material(*)

(*) machining is required.

The enclosure can be machined and drilled on request – gland holes from M16 to M40.



Terminal box with Glands

> FINISHING SERVICE

- Scame can supply these enclosures as empty components or after performing the following operations:
- Drilling entries
 - Tapping holes
 - Fitting terminals
 - Supplying suitable cable glands

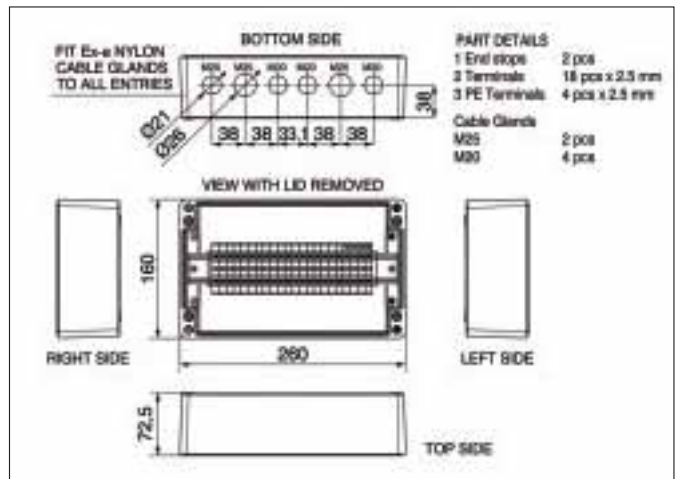

Terminal Box Assembly Drawing



Enclosure + ECP



Enclosure + Internal Plate



Terminal Box without Glands

ZENITH P Series

> MAXIMUM PERMITTED POWER DISSIPATION

Code	Enclosure size	Ambient 40°C T6 class		Ambient 60°C T6 class		Ambient 60°C T5 class		Ambient 75°C T4 class	
		(▲)	(●)	(▲)	(●)	(▲)	(●)	(▲)	(●)
644.0100	75x80x55	2.5	4.5	1.3	1.5	2.5	2.9	2.55	4.9
644.0200	75x80x75	2.6	4.6	1.3	1.5	2.6	3.1	2.9	5.2
644.0110	75x110x75	3.2	5	1.35	1.6	2.85	3.5	3.6	6
644.0210	75x110x75	3.4	5.1	1.35	1.65	3	3.8	4	6.4
644.0120	75x160x55	4.5	6	1.4	1.75	3.55	4.8	5.8	8.2
644.0220	75x160x75	4.7	6.1	1.45	1.8	3.6	4.9	6	8.4
644.0130	75x190x55	5.4	6.6	1.5	2	4	5.6	7	9.4
644.0230	75x190x75	5.5	6.7	1.55	2.05	4.05	5.7	7.2	9.85
644.0140	75x230x55	6.5	7.5	1.55	2.2	4.6	6.7	8.9	11.3
644.0240	75x230x75	6.6	7.6	1.6	2.25	4.7	6.8	9.2	11.6
644.0350	120x220x90	3.75	7	2.3	2	3.8	4.5	8.25	1.6
644.0360	160x160x90	3	6.4	2.5	1.7	3.2	4	6	14.5
644.0370	160x260x90	6.3	8.5	2.8	2.5	5.1	5.6	13.5	19.7
644.0380	160x360x90	UNDER DEVELOPMENT							
644.0390	160x560x90								



Terminal Box



Terminal Box

(▲) = for cage type terminals (●) = for screw type terminals

> MAXIMUM NUMBER OF TERMINALS - PHYSICAL DIMENSIONS

Code	Enclosure size	Term. Block	Mini 2.5mm ²	2.5mm ²	4mm ²	6mm ²	10mm ²	16mm ²	35mm ²
644.0100	75x80x55	6	9						
644.0200	75x80x75	6	9						
644.0110	75x110x75	10	15						
644.0210	75x110x75	10	15						
644.0120	75x160x55	18	25						
644.0220	75x160x75	18	25						
644.0130	75x190x55	24	30						
644.0230	75x190x75	24	30						
644.0140	75x230x55	30	38						
644.0240	75x230x75	30	38						
644.0350	120x220x90			36	30	24	19	15	11
644.0360	160x160x90			22	18	15	11	10	7
644.0370	160x260x90			40	35	27	21	18	13
644.0380	160x360x90			60	60	40	31	26	20
644.0390	160x560x90			100	82	65	51	42	32

The quantity of applicable terminals can be fitted in the enclosure is dependant on the internal width. The number may need to be reduced, depending on the actual current flowing in the conductors. In case the power dissipation of the terminals is superior to the maximum permitted power here stated, a different enclosure must be chosen or the temperature class must be changed.



Enclosure



Terminal Box

> APPROVED ATEX CERTIFIED TERMINALS

Terminals shall be selected from this list of approved manufacturers. Additional manufacturers are available on request after approval of our internal laboratory.

Terminal blocks (internal plate mounted) and mini terminals (DIN rail TS15) are suitable for use with small size enclosures. Standard rail terminals (DIN rail TS35) are suitable for use with large size enclosures.

When the enclosure is supplied as Ex i (low voltage instrumentation application), a suitable set of blue terminals is supplied.

Terminals can be screw type or spring cage. Cross section is from 1.5 mm² to 35 mm².

> WEIDMULLER

Terminal Block BK, MK – Mini Terminal AKZ – Terminal Type: WDU, ZDU, SAK, SAK K.



EX e - Ex i Terminals

> WAGO

Terminal Block 262, 264 – Terminal Type: 280, 281, 282, 283, 284 and 2002, 2004, 2006, 2010, 2016.

> PHOENIX

Terminal Type: UT, ST, DT, UK.

> ABB ENTRELEC

Terminal M ../.. EX.

> CABUR

Terminal Block BPL, TPL - Mini Terminal RN - Terminal CBD.



EX e Terminal Blocks

> DIN METALLIC RAILS

- Steel, cold lamination
- Electrolytic zinc coating
- Thickness of zinc coating: 8 micron min.

- Length of the rail: 2m
- Non drilled rail with drilling points provided
- Drilled rail with slots

> TYPE Ω TS 35 - Reference standard: CEI EN 60715

Dimensions (mm)	Description	Pack. Qty.	Code
35x7,5x1	Plain DIN rail	40m	865.220
	Slotted DIN rail (18x6,3 - 25)	40m	865.221

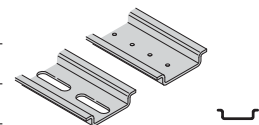

> TYPE Ω TS 15- Reference standard: CEI EN60715

Dimensions (mm)	Description	Pack. Qty.	Code
15x5,5x1	Plain DIN rail	100m	865.240
	Slotted DIN rail (12,2x4,2 - 20)	100m	865.241

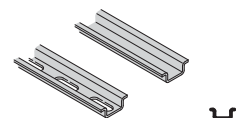

Terminal Box with Glands



Terminal Box

ZENITH P Series

> STANDARD ENTRY ARRANGEMENTS

Code	Enclosure size	Top/Bottom Sides A/C					Left/Right Sides B/D				Rear Side F		
		M16	M20	M25	M32	M40	M16	M20	M25	M32	M16	M20	M25
644.0100	75x80x55	1	1	-	-	-	1	-	-	-	-	-	-
644.0200	75x80x75	2	1	1	-	-	2	-	-	-	-	-	-
644.0110	75x110x55	3	2	-	-	-	1	-	-	-	-	-	-
644.0210	75x110x75	6	3	2	1	-	2	-	-	-	-	-	-
644.0120	75x160x55	5	4	-	-	-	1	-	-	-	-	-	-
644.0220	75x160x75	10	5	3	2	-	2	-	-	-	-	-	-
644.0130	75x190x55	6	5	-	-	-	1	-	-	-	-	-	-
644.0230	75x190x75	12	6	4	3	-	2	-	-	-	-	-	-
644.0140	75x230x55	6	4	-	-	-	1	-	-	-	-	-	-
644.0240	75x230x75	12	6	4	2	-	2	-	-	-	-	-	-
644.0350	120x220x90	14	9	4	3	-	4	2	1	1	-	-	-
644.0360	160x160x90	8	6	3	2	1	6	4	2	1	8	6	4
644.0370	160x260x90	16	12	6	4	3	6	4	2	1	16	12	8
644.0380	160x360x90	22	18	9	6	4	6	4	2	1	24	18	12
644.0390	160x560x90	36	28	14	8	6	6	4	2	1	36	28	20

> DRILLING ENVELOPE

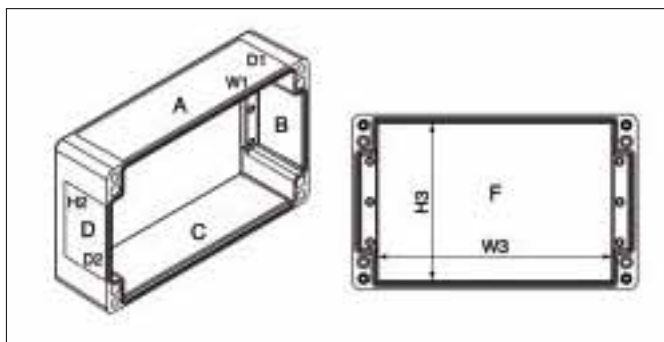

Cable gland size A (mm)	Clearance B (mm)
16	32
20	39
25	46
32	58
40	68

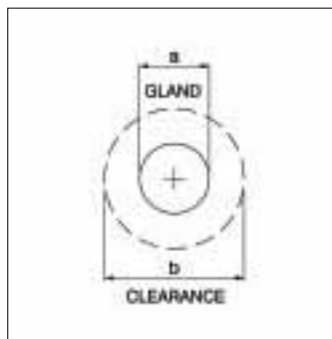

Code	Enclosure size	Top/Bottom sides A/C W1xD1	Left/Right sides B/D H2xD2	Rear side F H3xW3
644.0100	75x80x55	48x34	28x28	60x48
644.0200	75x80x75	48x54	27x48	60x48
644.0110	75x110x55	80x34	28x28	60x80
644.0210	75x110x75	80x54	27x48	60x80
644.0120	75x160x55	130x34	28x28	60x130
644.0220	75x160x75	130x54	27x48	60x130
644.0130	75x190x55	160x34	28x28	60x160
644.0230	75x190x75	160x54	27x48	60x160
644.0140	75x230x55	90x34(x2)	28x28	60x190
644.0240	75x230x75	90x54(x2)	27x48	60x190
644.0350	120x220x90	180x58	60x52	105x180
644.0360	160x160x90	110x65	84x56	140x110
644.0370	160x260x90	210x65	84x56	140x210
644.0380	160x360x90	310x65	84x56	140x310
644.0390	160x560x90	240x65(x2)	84x56	140x240(x2)



Cable Glands



Terminal Box

EUROPEAN DIRECTIVE 94/9/EC - ATEX DIRECTIVE (Europe) INTERNATIONAL STANDARD - IEC Ex SCHEME (Rest of the World)

> INCREASED SAFETY, Ex «e» ELECTRICAL EQUIPMENT - EQUIPMENT CATEGORY 2

The Principle of Protection Ex e

Ex e equipment is capable of being used in zone 1, 2, with any flammable gas or vapour (A,B and C) subject to the temperature class being appropriate. The method of protection can only be used for equipment which does not spark or reach excessive temperatures capable to ignite an explosive atmosphere in normal operation.

Items that should NOT be installed inside are: switches (unless Ex d), fuse terminals, test/disconnect terminals, uncertified terminal blocks.

Ex e enclosures are lighter, cheaper and easier to maintain compared to flameproof Ex d enclosures.

GUIDELINES ON THE APPLICATION OF DIRECTIVE 94/9/EC of 23 March 1994 - Equipment and protective systems intended for use in potentially Explosive Atmospheres



<http://ec.europa.eu/enterprise/atex/guide/index.htm>

IECEx Scheme - Equipment for use in Explosive Atmospheres (IECEx Scheme)



<http://www.iecex.com/rules.htm>

Detailed Installation, Operation and Maintenance Instructions are always included with the ZENITH P range.



Installation, operations & maintenance instructions



ZENITH P range for applications in Hazardous Environments

ZP00673-GB-1
8 001636407814



ScameOnLine
<http://www.scame.com/atex>
e-mail: atex@scame.com



SCAME PARRE S.p.A.
VIA COSTA ERTA, 15
24020 PARRE (BG) ITALY
TEL. +39 035 705000
TELEFAX +39 035 703122

