

Multistage Ejector *Series ZL*



New Models! ZL212 large flow rate type and ZL112 with valve.

Multistage Ejector



Series ZL 112/212

Energy saving, large flow rate, 3 stage diffuser construction

Suction flow rate increased 250% and air consumption reduced 20% with 3 stage diffuser construction
(Versus $\phi 1.3$, one stage model)

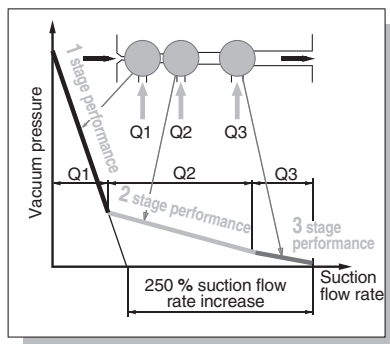

	Maximum suction flow rate ℓ/min (ANR)	Air consumption ℓ/min (ANR)
ZL112	100	63
ZL212	200	126

Series ZL212

Diffusers stacked and integrated
Compact size and large flow rate
(twice the flow rate of the ZL112)

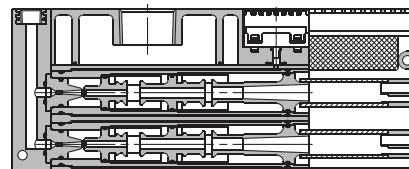

Series ZL112 valve option now available (ZL112 only)

Vacuum pressure sensor

With adaptor for vacuum

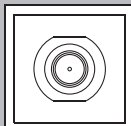

With vacuum pressure gauge

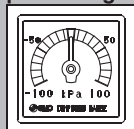

Digital vacuum pressure switch

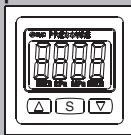

ZSE30A

- Rated pressure range: 0.0 to -101.0 kPa
- 3-step setting



Push

Adjust to set-value with Δ ∇ buttons.

Push

Finish setting

- Power-saving function

Power consumption is reduced by turning off the monitor. (Reduce power consumption by up to 20%.)

* For series ZSE30A, refer to the separate catalogue for details.

Release valve

Supply valve

Release flow rate adjustment needle

One-touch fitting feature

Makes piping work easy (ZL112 only)

Exhaust port options

Built-in silencer



Port exhaust



Series variations

Series	Maximum suction flow rate ℓ/min (ANR)	Air consumption ℓ/min (ANR)	Vacuum pressure sensor options						
			Exhaust port		With valve		Digital vacuum pressure switch ZSE30A	Vacuum pressure gauge	Vacuum adapter
			Built-in silencer	Port exhaust	With supply valve/ release valve	With supply valve			
ZL112	100	63	●	●	●	●	●	●	
ZL212	200	126	●	●			●	●	

Series ZL

Standard



With valve



With vacuum pressure gauge



Adapter



Port exhaust



Ejector Specifications

Model	ZL112
Nozzle diameter	ø1.2mm
Maximum suction flow rate	100ℓ/min (ANR)
Air consumption	63ℓ/min (ANR)
Maximum vacuum pressure	-84kPa
Maximum operating pressure	0.7MPa
Supply pressure range	0.2 to 0.5MPa
Standard supply pressure	0.4MPa
Operating temperature range	5 to 50°C

Supply/Release Valve Specifications

Part Number	SYJ514-□□□□
Type of valve actuation	N.C.
Fluid	Air
Operating pressure range Internal pilot type	0.15 to 0.7MPa
Ambient and fluid temperature	-10 to 50°C (No freezing)
Response time (for 0.5MPa) ^{Note 1)}	25ms or less
Maximum operating frequency	5Hz
Manual operation	Non-locking push type, Slotted locking type
Pilot exhaust type	Pilot valve individual exhaust type, Main valve/Pilot valve common exhaust
Lubrication	Not required
Mounting position	Unrestricted
Impact/Vibration resistance ^{Note 2)}	150/30m/s ²
Enclosure	Dust proof

Note 1) Based on JIS B8374-1981 dynamic performance test. (coil temperature 20°C, at rated voltage, without surge voltage suppressor)

Note 2) Impact resistance: No malfunction when tested with a drop tester in the axial direction and at a right angle to the main valve and armature, one time each in both energized and deenergized states. (initial value)

Vibration resistance: No malfunction when tested with one sweep of 45 to 2000Hz in the axial direction and at a right angle to the main valve and armature, one time each in both energized and deenergized states. (initial value)

Note 3) Refer to SYJ300/500/700 catalogue for details on valves.

Option Specifications

Vacuum pressure gauge specifications

Part number	GZ30S
Fluid	Air
Pressure range	-100 to 100kPa
Scale range (angular)	230
Accuracy	± 3% F.S. (full span)
Class	Class 3
Operating temperature range	0 to 50°C
Material	Housing: Polycarbonate/ABS resin

Symbol
Standard

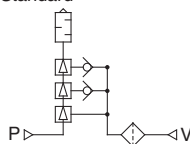

Weight

ZL112 (Basic)	450 g
Port exhaust	+110 g
Digital pressure switch for vacuum (Excluding lead wire)	+43 g
Digital pressure switch for vacuum (Including 3 cores lead wire)	+81 g
Digital pressure switch for vacuum (Including 4 cores lead wire)	+85 g
Valve (per 1 pc.)	+45 g

Multistage Ejector *Series ZL*

With digital vacuum pressure switch (ZSE30A)



Specifications

Rated pressure range	0.0 to -101.0 kPa		
Set pressure range	10.0 to -105.0 kPa		
Withstand pressure	500 kPa		
Minimum unit setting	0.1 kPa		
Applicable fluid	Air, Non-corrosive gas, Non-flammable gas		
Power supply voltage	12 to 24 VDC ±10% (with power supply polarity protection)		
Current consumption	40 mA (at no load)		
Switch output	NPN or PNP open collector 1 output NPN or PNP open collector 2 outputs (selectable)		
Maximum load current	80 mA		
Maximum applied voltage	28 V (at NPN output)		
Residual voltage	1 V or less (with load current of 80 mA)		
Response time	2.5 ms or less (with anti-chattering function: 20, 100, 500, 1000, 2000 ms)		
Short circuit protection	Yes		
Repeatability	±0.2% F.S. ±1 digit		
Hysteresis mode	Variable (0 to variable)		
Window comparator mode			
Analogue output	Voltage output (Note 1)	Output voltage (Rated pressure range)	1 to 5 V ±2.5% F.S.
	Current output (Note 2)	Linearity	±1% F.S. or less
		Output impedance	Approx. 1 kΩ
	Load impedance	Maximum load impedance: Power supply voltage 12 V: 300 Ω, Power supply voltage 24 V: 600 Ω Minimum load impedance: 50 Ω	
Display	4-digit, 7-segment, 2-color LCD (Red/Green) Sampling cycle: 5 times/sec.		
Display accuracy	±2% F.S. ±1 digit (Ambient temperature of 25°C)		
Indicator light	Lights up when switch output is turned ON. (OUT1: Green, OUT2: Red)		
Environment resistance	Enclosure	IP40	
	Operating temperature range	Operating: 0 to 50°C, Stored: -10 to 60°C (No freezing or condensation)	
	Operating humidity range	Operating/Stored: 35 to 85% RH (No condensation)	
	Withstand voltage	1000 VAC for 1 minute between terminals and housing	
Insulation resistance	50 MΩ or more (500 VDC measured via megohmmeter) between terminals and housing		
Temperature characteristics	±2% F.S. (Based on 25°C)		
Lead wire	Oilproof heavy-duty vinyl cable, 3 cores φ3.5, 2 m 4 cores Conductor area: 0.15 mm ² (AWG26) Insulator O.D.: 1.0 mm		
Standards	CE Marking, UL/CSA, RoHS compliance		

Note 1) When analogue voltage output is selected, analogue current output cannot be used together.
Note 2) When analogue current output is selected, analogue voltage output cannot be used together.

* The vacuum pressure switch mounted on this product is equivalent to our SMC product, the ZSE30A series compact digital pressure switch.

For details about vacuum pressure switch functions, refer to the Operation Manual for Series ZSE30A that can be downloaded from our website (<http://www.smceu.com>).

●Pressure switch correspondence table

Digital pressure switch
Series ZSE30A

ZSE30A-00-□-□

Multistage ejector
Series ZL

ZL * 12** -***** -D □ -□

Multistage ejector
suction cover assembly

ZL * 12-SC-D □ -□

Output specifications

Lead wire specifications

How to Order Suction Filter Assembly

It is impossible to replace only the vacuum pressure switch. Please replace the suction filter assembly.

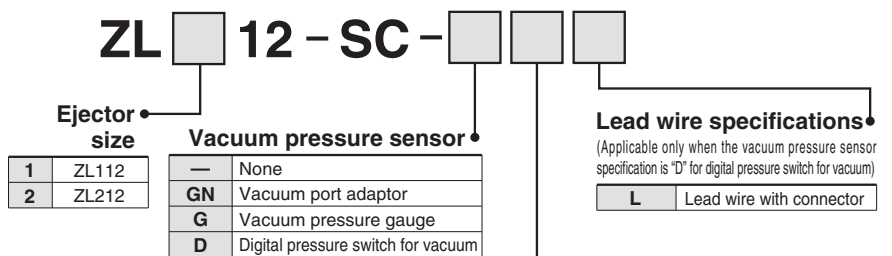

Output specifications

(Applicable only when the vacuum pressure sensor specification is "D" for digital pressure switch for vacuum)

N	NPN open collector 1 output
P	PNP open collector 1 output
A	NPN open collector 2 outputs
B	PNP open collector 2 outputs
C	NPN open collector 1 output+Analogue voltage output
D	NPN open collector 1 output+Analogue current output
E	PNP open collector 1 output+Analogue voltage output
F	PNP open collector 1 output+Analogue current output

Series ZL

Construction

Without valve

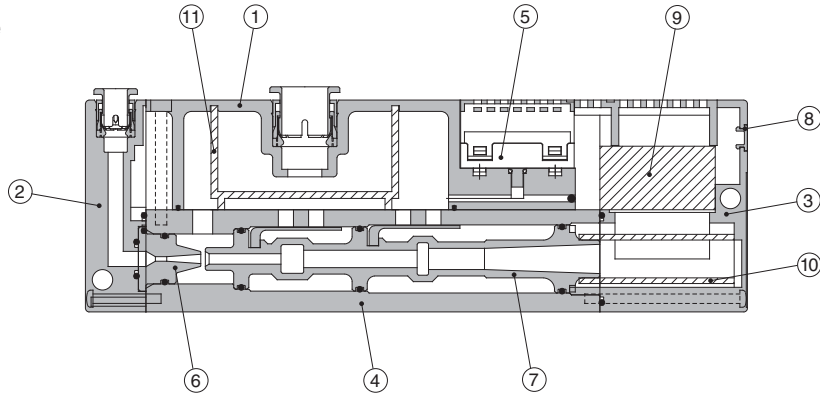

With valve

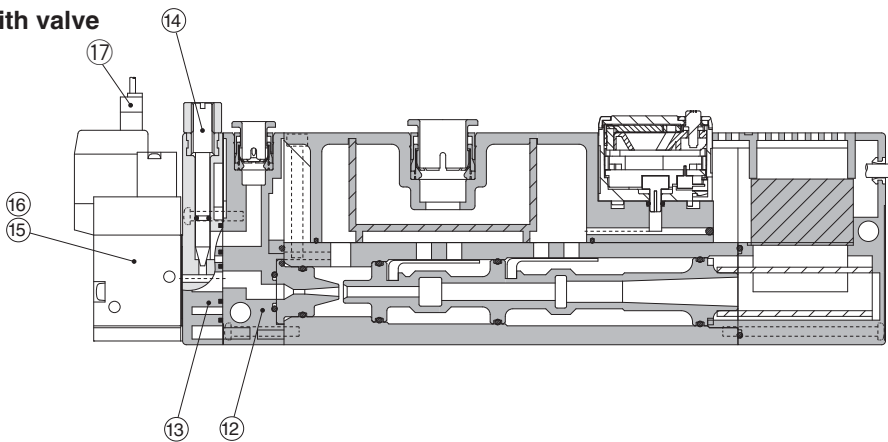

Component Parts

No.	Description	Part no.	Note
1	Suction cover		
2	Front cover		Without valve
3	End cover		
4	Body		
5	Vacuum sensor unit		
6	Nozzle		
7	Diffuser		
8	Detent plug		Other than vacuum switch
	Lead wire cover		Vacuum switch specifications
12	Front cover B		With valve
13	Valve plate		With valve
14	Needle		With valve
15	Supply valve (N.C.)	SYJ514-□□□	With valve
16	Release valve (N.C.)	SYJ514-□□□	With valve
17	Connector assembly	SYJ100-30-□A-□	With valve (Table1.)

Replacement Parts

No.	Description	Material	Part no.
9	Sound absorbing material B	PVF	ZL112-SP01 (Set no. for 9, 10 & 11)
10	Sound absorbing material A	PVF	
11	Suction filter	PE	

Table1. How to order connector assembly

For DC

SY100-30-4A-□

For 100 VAC

SY100-30-1A-□

For other AC

SY100-30-3A-□

Lead wire length ●

Nil	300mm(Standard)
6	600mm
10	1000mm
15	1500mm
20	2000mm
25	2500mm
30	3000mm
50	5000mm

Dimensions/Series ZL112 (without Valve)

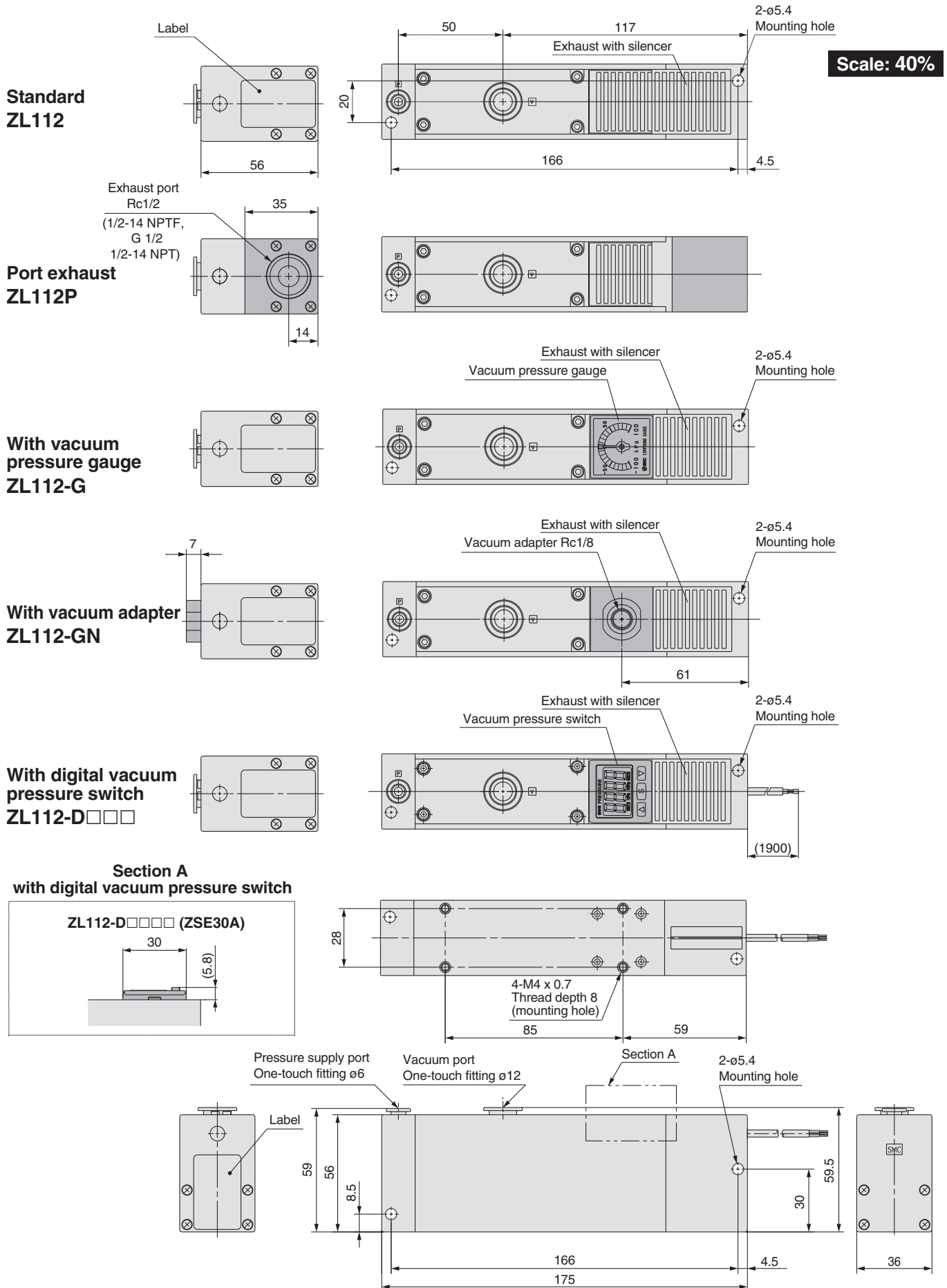

Series ZL

Dimensions/Series ZL112 (with Valve)

With supply valve and release valve
ZL112-K1□L□□-D□□□

Scale: 40%

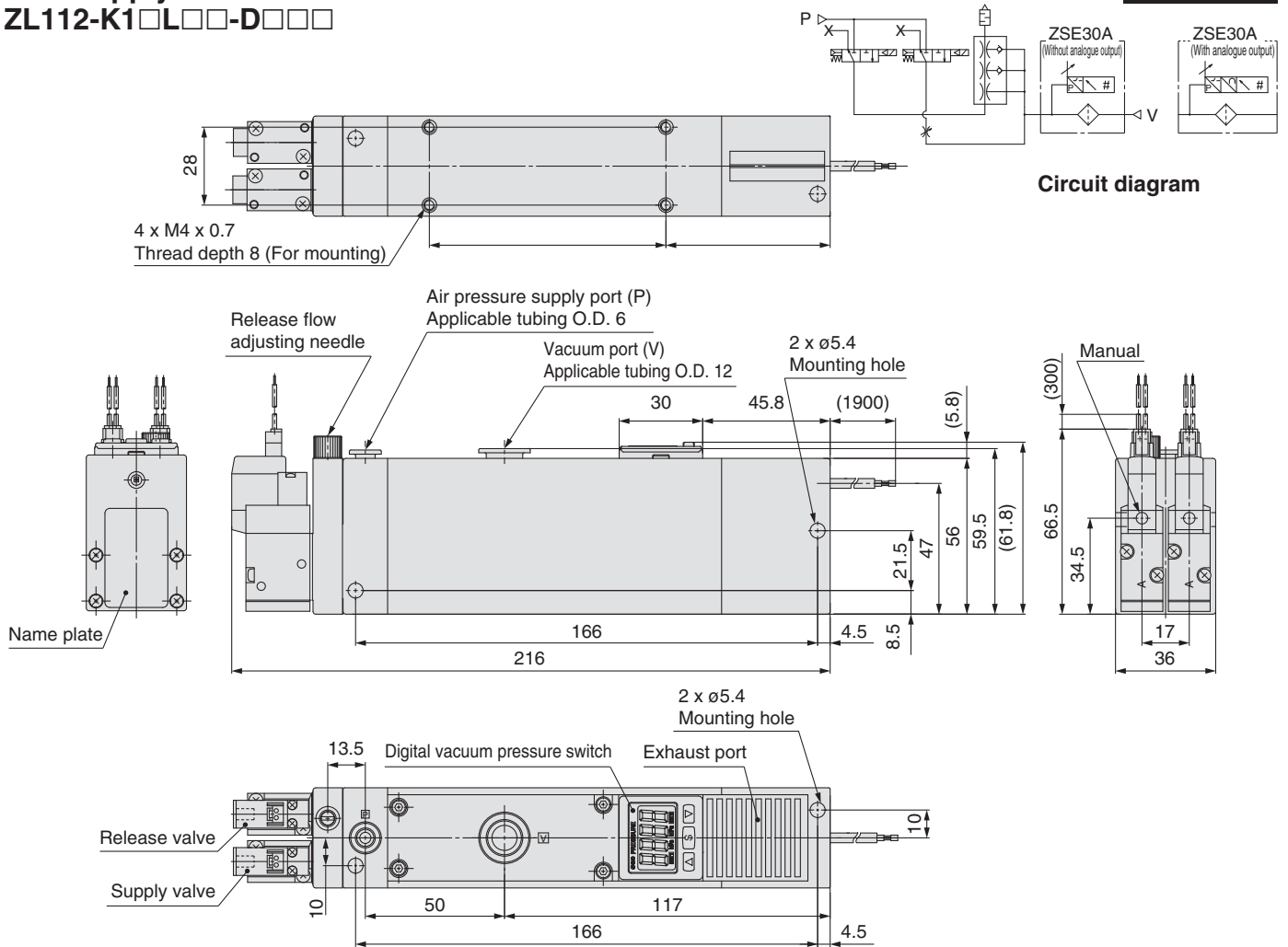

With supply valve
ZL112-K2□L□□-D□□□

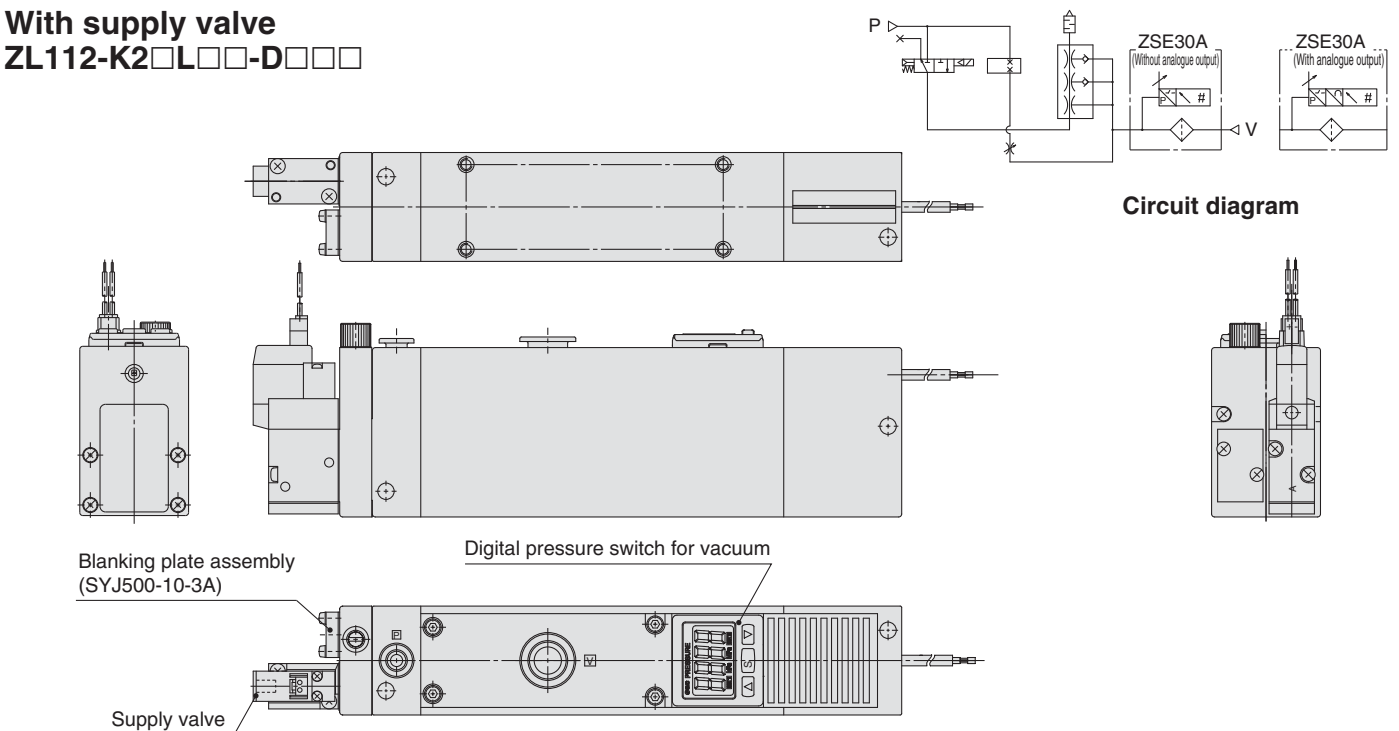

Multistage Ejector Series ZL212

Standard



With vacuum pressure gauge



With digital vacuum pressure switch



With adaptor



Port exhaust



How to Order

ZL2 12 □ □ □ -Q

Nozzle diameter
12 ϕ 1.2mm

Exhaust specifications

-	Built-in silencer
P	Port exhaust

Vacuum pressure sensor

-	None
GN	Adaptor Rc1/8
G	With vacuum pressure gauge
D	With digital vacuum pressure switch ZSE30A

Lead wire specifications

L	2 m
---	-----

Note) Applicable only when the vacuum pressure sensor specification is "D" for digital pressure switch for vacuum)

Output specifications

N	NPN open collector 1 output
P	PNP open collector 1 output
A	NPN open collector 2 outputs
B	PNP open collector 2 outputs
C	NPN open collector 1 output + Analogue voltage output
D	NPN open collector 1 output + Analogue current output
E	PNP open collector 1 output + Analogue voltage output
F	PNP open collector 1 output + Analogue current output

Note) Applicable only when the vacuum pressure sensor specification is "D" for digital pressure switch for vacuum)



Made to Order
(Refer to page 17 for details.)

Symbol	Specifications/Contents
X132	Supply valve/Vacuum release valve

Ejector Specifications

Model	ZL212
Nozzle diameter	ϕ 1.2mm x 2
Maximum suction flow rate	200 ℓ /min (ANR)
Air consumption	126 ℓ /min (ANR)
Maximum vacuum pressure	-84kPa
Maximum operating pressure	0.7MPa
Supply pressure range	0.2 to 0.5MPa
Standard supply pressure	0.4MPa
Operating temperature range	5 to 50°C

Symbol
Standard

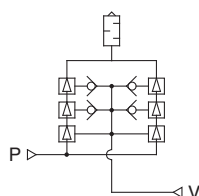

Weight

ZL212	700 g
Port exhaust	+300 g
Digital pressure switch for vacuum (Excluding lead wire)	+43 g
Digital pressure switch for vacuum (Including 3 cores lead wire)	+81 g
Digital pressure switch for vacuum (Including 4 cores lead wire)	+85 g
Valve (per 1 pc.)	+45 g

Series ZL

Construction

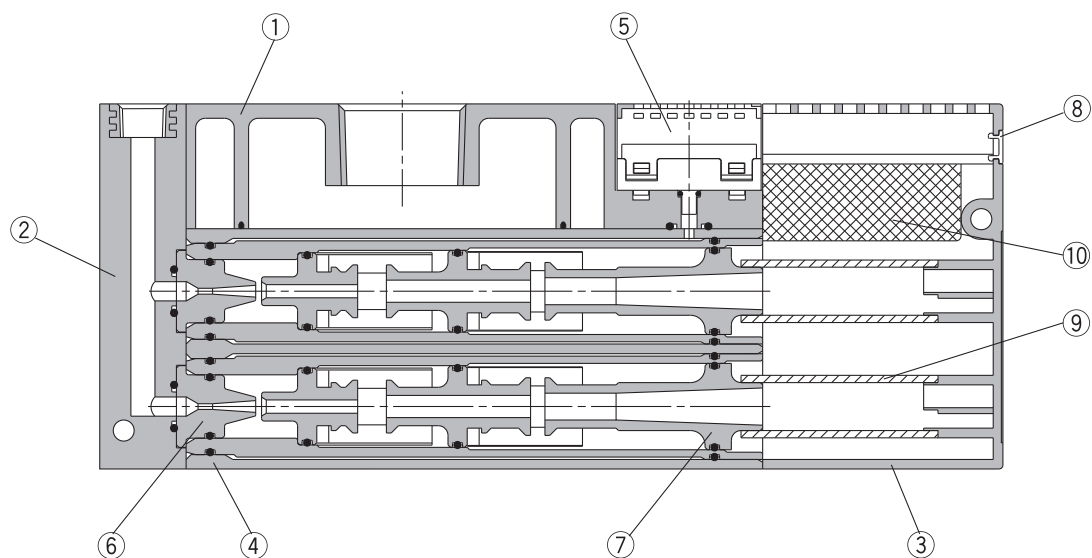

Parts list

No.	Description	Note
1	Suction cover	
2	Front cover A	
3	End plate	
4	Body	
5	Vacuum sensor unit	
6	Nozzle	
7	Diffuser	
8	Detent plug	Other than vacuum switch
	Lead wire cover	Vacuum switch specifications

Replacement parts

No.	Description	Material	Part No.
9	Sound absorbing material A	PVF	ZL212-SP01
10	Sound absorbing material	PVF	(Set no. for 9 & 10)

Dimensions/Series ZL212

Scale: 40%

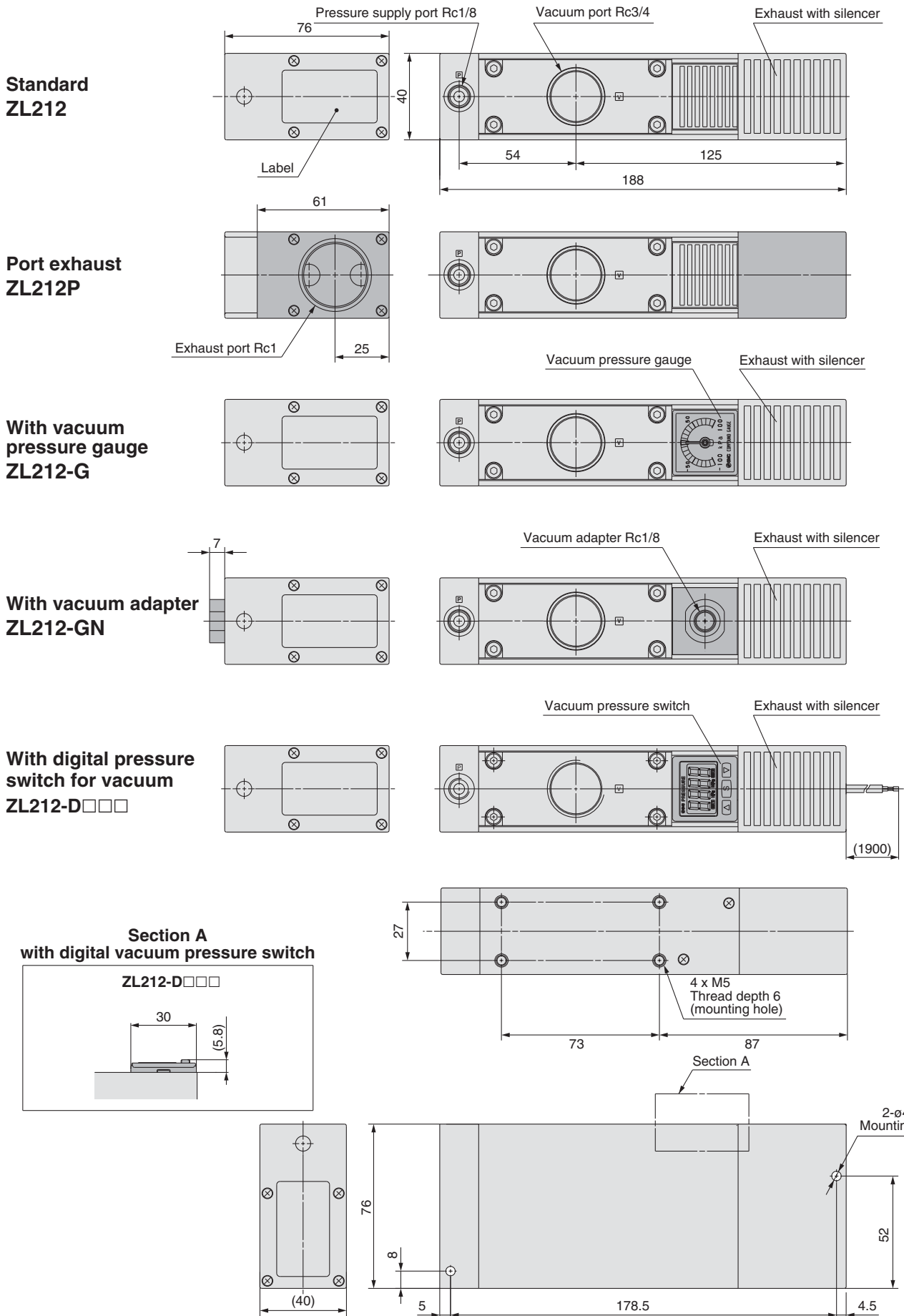





Series ZL Safety Instructions

These safety instructions are intended to prevent a hazardous situation and/or equipment damage. These instructions indicate the level of potential hazard by labels of "Caution", "Warning" or "Danger". To ensure safety, be sure to observe ISO 4414 ^{Note 1)}, JIS B 8370 ^{Note 2)} and other safety practices.

 **Caution** : Operator error could result in injury or equipment damage.

 **Warning** : Operator error could result in serious injury or loss of life.

 **Danger** : In extreme conditions, there is a possible result of serious injury or loss of life.

Note 1) ISO 4414 : Pneumatic fluid power – Recommendations for the application of equipment to transmission and control systems.

Note 2) JIS B 8370 : General Rules for Pneumatic Systems

Warning

1. The compatibility of pneumatic equipment is the responsibility of the person who designs the pneumatic system or decides its specifications.

Since the products specified here are used in various operating conditions, their compatibility for the specific pneumatic system must be based on specifications or after analysis and/or tests to meet your specific requirements.

2. Only trained personnel should operate pneumatically operated machinery and equipment.

Compressed air can be dangerous if an operator is unfamiliar with it. Assembly, handling or repair of pneumatic systems should be performed by trained and experienced operators.

3. Do not service machinery/equipment or attempt to remove components until safety is confirmed.

1. Inspection and maintenance of machinery/equipment should only be performed after confirmation of safe locked-out control positions.
2. When equipment is to be removed, confirm the safety process as mentioned above. Cut the supply pressure for this equipment and exhaust all residual compressed air in the system.
3. Before machinery/equipment is restarted, take measures to prevent shooting-out of cylinder piston rod, etc. (Bleed air into the system gradually to create back pressure.)

4. Contact SMC if the product is to be used in any of the following conditions:

1. Conditions and environments beyond the given specifications, or if product is used outdoors.
2. Installation on equipment in conjunction with atomic energy, railway, air navigation, vehicles, medical equipment, food and beverages, recreation equipment, emergency stop circuits, press applications, or safety equipment.
3. An application which has the possibility of having negative effects on people, property, or animals, requiring special safety analysis.



Series ZL Vacuum Equipment Precautions 1

Be sure to read before handling.

Selection

⚠ Warning

1. Confirm the specifications.

The products appearing in this catalog are designed for use only in compressed air systems (including vacuum).

Do not use outside the specified ranges of pressure, temperature, etc., as this may cause damage or faulty operation. (Refer to specifications.)

Consult with SMC if fluids other than compressed air (including vacuum) are to be used.

Mounting

⚠ Warning

1. Read the instruction manual carefully.

The product should be mounted and operated with a good understanding of its contents. Also, keep the manual where it can be easily referred to at any time.

2. Ensure space for maintenance.

Ensure the necessary space for maintenance activities.

3. Be sure to tighten screws with the proper torque.

When mounting, tighten screws with the recommended torque.

Piping

⚠ Caution

1. Preparation before piping

Before piping is connected, it should be thoroughly blown out with air (flushing) or washed to remove chips, cutting oil and other debris from inside the pipe.

2. Wrapping of pipe tape

When screwing together pipes and fittings, etc., be certain that chips from the pipe threads and sealing material do not get inside the piping.

Further, when pipe tape is used, leave 1.5 to 2 thread ridges exposed at the end of the threads.

Air Supply

⚠ Warning

1. Types of fluid

This product is designed for use with pressurized air. Consult with SMC if a different fluid is to be used.

Consult SMC regarding products to be used with general purpose fluids, to confirm which fluids may be used.

2. When there is a large amount of drainage

Pressurized air containing a large amount of drainage can cause the malfunction of pneumatic equipment. An air dryer or Drain Catch should be installed upstream from filters.

3. Drain management

If the air filter drains are not flushed regularly, the drainage will flow downstream from the drains and this may lead to the malfunction of pneumatic equipment.

In cases where the management of drain flushing will be difficult, the use of filters with automatic drains is recommended.

For details on the qualities of compressed air, refer to SMC's "Air Cleaning Equipment" catalog.

Air Supply

⚠ Warning

4. Types of air

Do not use compressed air containing chemicals, synthetic oil which includes organic solvents, salt, corrosive gases, etc., as this may cause damage or malfunction.

Operating Environment

⚠ Warning

1. Do not operate in locations having an atmosphere of corrosive gases, chemicals, sea water, fresh water or water vapor, or where there will be contact with the same.

2. In locations which receive direct sunlight, the sunlight should be blocked .

3. Do not operate in locations where vibration or impact occurs.

4. Do not operate in locations near heat sources where radiated heat will be received.

Maintenance

⚠ Warning

1. Maintenance should be performed in accordance with procedures in the instruction manual.

Improper handling may cause damage or malfunction of equipment or machinery.

2. Maintenance work

Improper handling of compressed air is dangerous. Therefore, in addition to observing the product specifications, replacement of elements and other maintenance activities should be performed by personnel having sufficient knowledge and experience pertaining to pneumatic equipment.

3. Drain flushing

Drainage should be flushed from air filter and other drains on a regular basis. (Refer to specifications.)

4. Pre-maintenance inspection

When removing this product, turn off the electric power and be certain to shut off the supply pressure and exhaust the compressed air in the system. Proceed only after confirming that all pressure has been released to the atmosphere.

5. Post maintenance inspection

After installation, repair or reconstruction, reconnect pressurized air and electric power, and then perform inspections for proper operation and air leakage. If the sound of air leakage can be heard, or if the equipment does not operate properly, stop operation and confirm that it is mounted correctly.

6. Disassembly and alteration prohibited.

Do not disassemble the unit or make any alterations to it.



Series ZL Vacuum Equipment Precautions 2

Be sure to read before handling.

Design & Selection

Warning

1. **Create a safe design, which addresses the possibility of accidents resulting from a drop in vacuum pressure due to power failure or trouble with the air supply, etc.**

If vacuum pressure drops and there is a loss of vacuum pad adsorption force, work pieces being carried may fall, causing a danger of human injury and/or damage to machinery. Safety measures should be implemented, such as the installation of drop prevention guides.

2. **Use vacuum specifications for vacuum switching valves and vacuum breakers.**

If valves which do not meet vacuum specifications are installed in vacuum piping, vacuum leakage will occur. Be certain to use vacuum specification valves.

3. **Select ejectors which have a suitable suction flow rate.**

<When there is a vacuum leak from the work piece or the piping>

If the ejector's suction flow rate is too low, this will cause poor adsorption.

<When piping is long or of large diameter>

The adsorption response time will increase due to the increased volume of the piping.

Select ejectors with a suitable suction flow rate by referring to their technical data.

4. **If the suction flow rate is too high, setting of vacuum switches will become difficult.**

In the case of adsorption on a small work piece of only a few millimeters, if an ejector is selected which has a high suction flow rate, the pressure difference when adsorbing and releasing the work piece is small. Since setting of the vacuum switch may become difficult, an appropriate ejector should be selected.

5. **When two or more pads are piped to one ejector, if one pad releases its work piece, the other pads will also release.**

When one pad is removed from its work piece, there is a drop in vacuum pressure which causes the other pads to release their work pieces also.

6. **Use piping with an adequate effective sectional area.**

Select piping for the vacuum side which has an adequate effective sectional area, so that the ejector's maximum suction flow rate can be accommodated by the piping.

Also, make sure that there are no unnecessary restrictions or leaks, etc., along the course of the piping.

The piping on the air supply side must be designed so that it corresponds to each ejector's air consumption. The effective sectional area of tubing, fittings and valves, etc., should be sufficiently large, and the pressure drop reaching the ejector should be kept to a minimum.

Further, design of the air supply should be performed while taking into consideration the ejector's maximum air consumption and the air consumption of other pneumatic circuits.

Caution

1. **For information on related items, such as directional control equipment and drive equipment, refer to the caution sections in each respective catalog.**

Mounting

Warning

1. **Do not obstruct the exhaust port of the ejector.**
If the exhaust port is obstructed when mounted, a vacuum will not be generated.

Piping

Caution

1. **Avoid disorganized piping.**

Piping which is direct and of the shortest possible length should be used for both the vacuum and supply sides, and disorganized piping should be avoided. Unnecessary length increases the piping volume, and this increases the response time.

2. **Use piping having a large effective sectional area on the exhaust side of the ejector.**

If the exhaust piping is restrictive, there will be a decline in the ejector's performance.

3. **Make sure that there are no crushed areas in the piping due to damage or bending.**

Operating Environment

Warning

1. **Do not operate in locations having an atmosphere of corrosive gases, chemicals, sea water, water or steam, or where there will be contact with the same.**
2. **Do not operate in locations having an explosive atmosphere.**
3. **Do not operate in locations where vibration or impact occurs.**
Confirm the specifications for each series.
4. **In locations which receive direct sunlight, provide a protective cover, etc.**
5. **In locations near heat sources, block off any radiated heat.**
6. **In locations where there is contact with water, oil or welding spatter, etc., implement suitable protective measures.**
7. **In cases where the vacuum unit is surrounded by other equipment or it is energized for an extended time etc., implement measures to radiate excess heat so that temperatures remain within the range of specifications.**

Maintenance

Warning

1. **Clean suction filters and silencers on a regular basis.**
The performance of ejectors will deteriorate due to clogging in filters and silencers. Large capacity filters should be used, especially in dusty locations.



Series ZL

Electronic Pressure Switch Precautions 1

Be sure to read before handling.

Design & Selection

Warning

1. Use with the specified voltage.

Use with voltage outside of the specifications can cause malfunction or switch damage, as well as electrocution and fire hazard, etc.

2. Never use a load which exceeds the maximum load capacity.

This may damage a switch or reduce its service life.

3. Do not use a load that generates surge voltage.

Although surge protection is provided at the output side of a switch, damage may still occur if the surge is applied repeatedly. When a load, such as a relay or solenoid, which generates surge is directly driven, use a type of switch having a built-in surge absorbing element.

4. Be sure to confirm the fluid specifications.

Since switches do not have explosion-proof construction, do not use flammable gases or fluids. This may cause a fire or explosion.

5. Be certain to observe the regulating pressure range and maximum operating pressure.

Operation at a pressure outside of this range can cause failure. In addition, the switch will be broken if operated above the maximum operating pressure.

Mounting

Warning

1. Do not use if equipment does not operate properly.

Verify correct mounting by suitable function and leakage inspections after air and power are connected following mounting, maintenance or conversions.

2. Do not drop or bump.

Do not drop, bump or apply excessive impact (1000m/s²) when handling. Even if the switch body is not damaged, the switch may suffer internal damage that will lead to malfunction.

3. Hold the product from the body side when handling.

The tensile strength of the power cord is 49N, and pulling it with a force greater than this can cause failure. Hold by the body when handling.

4. Turn the setting trimmer gently using a watchmakers screw driver.

Turn the setting trimmer gently using a watchmakers screw driver. Do not turn beyond the stoppers located at both ends. If the trimmer is broken, adjustment will be impossible.

5. Pressure port

Do not insert wire, etc., from the pressure port. This will damage the pressure sensor, making it impossible to obtain normal operation.

Wiring

Warning

1. Confirm wire colors and terminal numbers when wiring is performed.

Since incorrect wiring can lead to breakage or failure of the switch as well as malfunction, perform wiring after confirming wiring colors and terminal numbers with the instruction manual.

2. Avoid repeatedly bending or stretching lead wires.

Broken lead wires will result from applying bending stress or stretching force to the lead wires. In the event that lead wires are damaged creating a possibility of malfunction, replace the entire product. (For cases in which the lead wires cannot be replaced through grommets.)

3. Confirm proper insulation of wiring.

Be certain that there is no faulty wiring insulation (contact with other circuits, ground fault, improper insulation between terminals, etc.). Damage may occur due to excess current flow into a switch.

4. Do not wire with power lines or high voltage lines.

Wire separately from power lines or high voltage lines, avoiding parallel wiring or wiring in the same conduit with these lines. Control circuits containing switches may malfunction due to noise from these other lines.

5. Do not allow short circuiting of loads.

Use caution, as switches will be damaged instantly if a load is short circuited. Be especially careful not to reverse the power supply line (Brown) and the output line (Black).

Pressure Source

Warning

1. Observe the fluid and ambient temperature ranges.

The fluid and ambient temperatures are 0 to 60°C. Since moisture in circuits can freeze at 5°C or below, causing damage to O-rings and malfunction, take measures to prevent freezing. The installation of an air dryer is recommended to remove drainage and moisture from circuits. Furthermore, even though the ambient temperature range remains within specifications, do not operate in locations where there are abrupt temperature changes.

2. Vacuum pressure switches

There will be no change in performance if a pressure of 0.5MPa or less is applied for 1 second or less (when releasing a vacuum), but care should be taken that pressures of 0.2MPa or more are not applied on a regular basis.



Series ZL Electronic Pressure Switch Precautions 2

Be sure to read before handling.

Operating Environment

Warning

1. Never use in an atmosphere of explosive gases.

The structure of pressure switches is not intended to prevent explosion. Never use in an atmosphere with an explosive gas since this may cause a serious explosion.

2. Do not use in locations with sources of surge generation.

When equipment that generates a large amount of surge (solenoid type lifters, high frequency induction furnaces, motors, etc.) is located in the area around a pressure switch, there is a danger of deterioration or damage to the switch's internal circuit elements. Therefore, implement surge countermeasures at the sources, and avoid the mixing and touching of lines.

3. Operating environment

Since the electronic pressure switch is basically an open type, avoid use in locations where there is splashing of water or oil, etc.

Maintenance

Warning

1. Perform maintenance regularly and confirm normal operation.

It may otherwise not be possible to assure safety due to unexpected malfunction or misoperation, etc.

2. When used in an interlock circuit

When used in an interlock circuit, provide multiple interlock circuits as a precaution against failure, and also perform regular inspections to confirm normal operation.

3. Cleaning the case

Use a soft cloth to clean the case. In case of heavy soiling, first soak the cloth in a neutral detergent diluted with water and wring it out thoroughly. Finish up by wiping with a dry cloth.



Series ZL Specific Product Precautions 1

Be sure to read before handling.

Refer to pages 10 through 14 for safety instructions, vacuum equipment precautions and electronic pressure switch precautions.

Piping

Caution

1. Connect the compressed air supply piping separately to the solenoid valves and ejector valves. Also, connect piping to the ejector valve stations.

Operation of Ejector Valves

Caution

1. When the pilot valve for air supply is turned ON, the main valve switches, and vacuum is generated by the flow of compressed air from the nozzle to the diffuser. When the pilot valve for vacuum release is turned ON, the main valve switches, and the vacuum is quickly released as air passes through the release flow adjustment needle and flows to the vacuum port.

Environment

Caution

1. Operate away from direct sunlight.

Solenoid Valves (Series ZL112/ZL212)

Caution

1. For specific product precautions on solenoid valves (Series ZL112), refer to the solenoid valve (Series SYJ500) catalogue.



Series ZL Specific Product Precautions 2

Be sure to read before handling.

Refer to pages 10 through 14 for safety instructions, vacuum equipment precautions and electronic pressure switch precautions.

Selection

ZL112

Exhaust characteristics

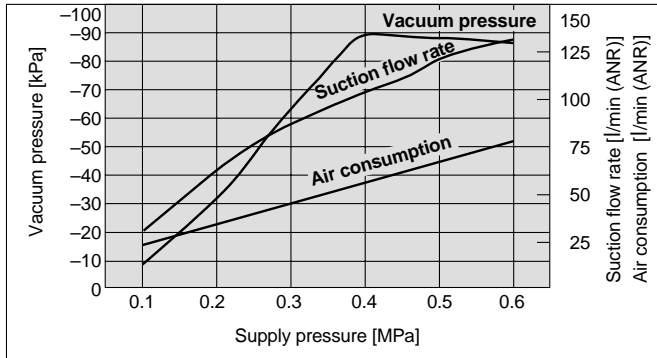

Flow rate Characteristics

Supply pressure: 0.4MPa

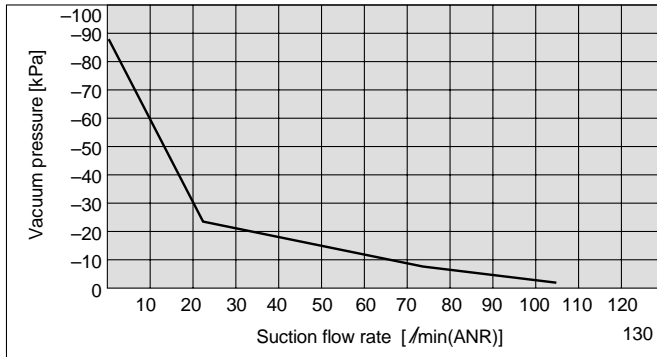

Time to reach vacuum

Measurement conditions/Tank capacity: 1 / Supply pressure: 0.4MPa

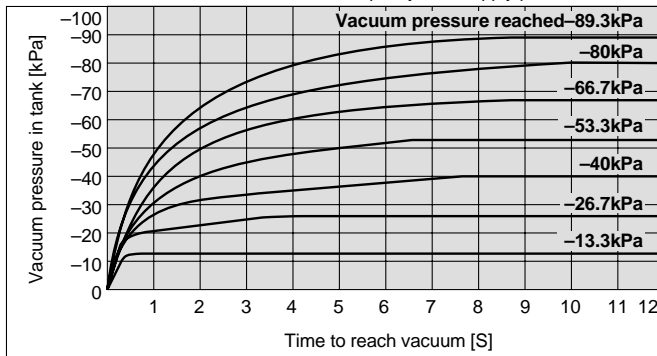

Viewing the graphs

The graphics indicate the time required to reach a vacuum pressure determined by adsorption conditions for work pieces, etc., starting from atmospheric pressure in a 1 /sealed tank. Approximately 8.8 seconds are necessary to attain a vacuum pressure of -89.3kPa.

ZL212

Exhaust characteristics

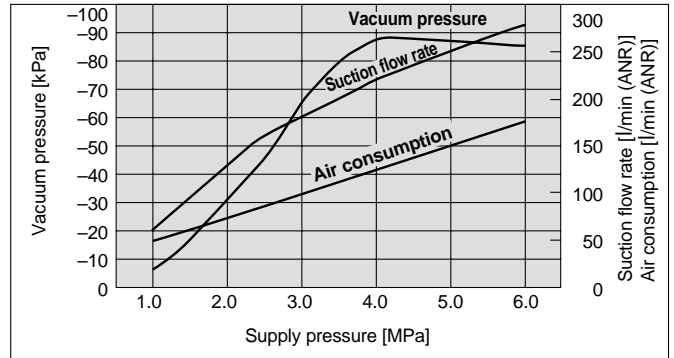

Flow rate characteristics

Supply pressure: 0.4MPa

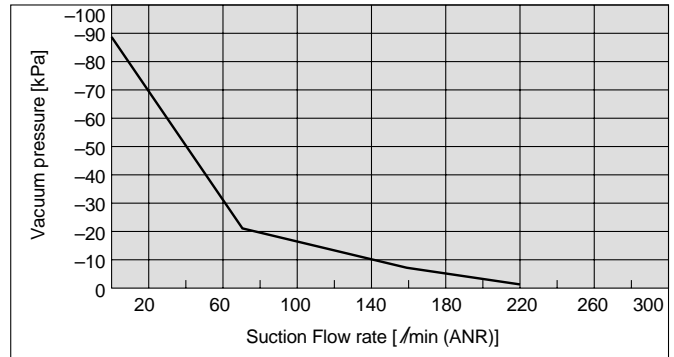

Time to reach vacuum

Measurement conditions/Tank capacity: 1 / Supply pressure: 0.4MPa

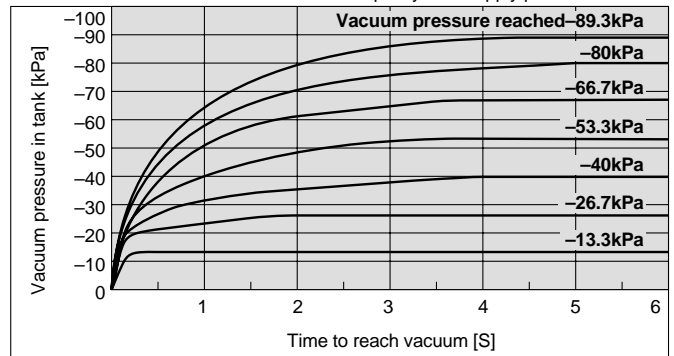

Viewing the graphs

The flow rate characteristics indicate the relationship between the vacuum pressure and the suction flow rate of the ejector, and show that when the suction flow rate changes the vacuum pressure also changes. In general, this indicates the relationship at the ejector's standard operating pressure. In the graph, Pmax indicates the maximum vacuum pressure, and Qmax indicates the maximum suction flow rate. These are the values that are published as specifications in catalogs, etc. Changes in vacuum pressure are explained below.

1. If the ejector's suction port is closed and sealed tight, the suction flow rate becomes "0" and the vacuum pressure increases to the maximum (Pmax).
2. If the suction port is opened and air is allowed to flow (the air leaks), the suction flow rate increases and the vacuum pressure decreases. (the condition of P1 and Q1)
3. If the suction port is opened completely, the suction flow rate increases to the maximum (Qmax), while the vacuum pressure then drops almost to "0" (atmospheric pressure).

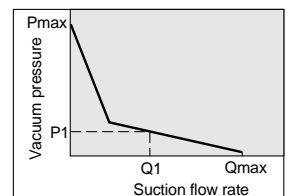

When adsorbing work pieces which are permeable or subject to leakage, etc., caution is required as the vacuum pressure will not be very high.



1 With Supply and Release Valves

ZL212 Valve Voltage Electrical entry — Vacuum pressure switch Electrical entry — X132

With supply and release valves

ZL212 type with supply and release valves



Dimensions

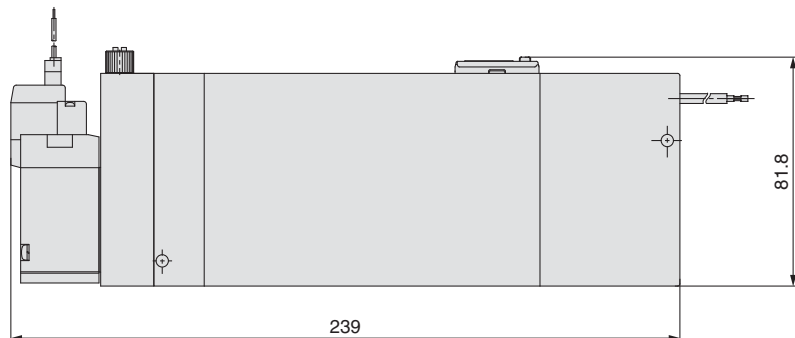
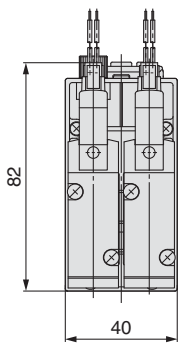
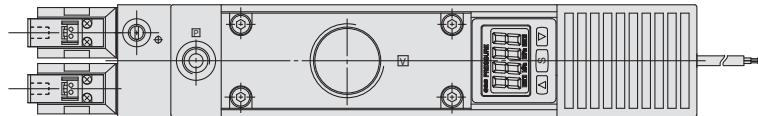

**Austria**

SMC Pneumatik GmbH (Austria).
Girakstrasse 8, A-2100 Korneuburg
Phone: 02262-62280, Fax: 02262-62285

**Belgium**

SMC Pneumatics N.V./S.A.
Nijverheidsstraat 20, B-2160 Wommelgem
Phone: 03-355-1464, Fax: 03-355-1466

**Czech**

SMC Czech s.r.o.
Kodanska 46, CZ-100 10 Prague 10
Phone: 02-67154 790, Fax: 02-67154 793

**Denmark**

SMC Pneumatik A/S
Jens Juuls vej 32, DK-8260 Viby J
Phone: 45-70252900, Fax: 45-70252901

**Estonia**

Teknoma Eesti AS
Mustamäe tee 5, EE-0006 Tallinn, Estonia
Phone: 259530, Fax: 259531

**Finland**

SMC Pneumatikka OY
Veneentekijäntie 7, SF-00210 Helsinki
Phone: 09-681021, Fax: 09-6810233

**France**

SMC Pneumatique, S.A.
1, Boulevard de Strasbourg, Parc Gustave Eiffel
Bussy Saint Georges
F-77607 Marne La Vallée Cedex 3
Phone: 01-6476 1000, Fax: 01-6476 1010

**Germany**

SMC Pneumatik GmbH
Boschring 13-15, D-63329 Egelsbach
Phone: 06103-4020, Fax: 06103-402139

**Greece**

S. Parianopoulos S.A.
9, Konstantinoupolos Street,
GR-11855 Athens
Phone: 01-3426076, Fax: 01-3455578

**Hungary**

SMC Hungary Kft.
Budafoki ut 107-113, 1117 Budapest
Phone: 01-204 4366, Fax: 01-204 4371

**Ireland**

SMC Pneumatics (Ireland) Ltd.
2002 Citywest Business Campus,
Naas Road, Saggart, Co. Dublin
Phone: 01-403 9000, Fax: 01-464 0500

**Italy**

SMC Italia S.p.A
Via Garibaldi 62, I-20061 Carugate, (Milano)
Phone: 02-92711, Fax: 02-92150394

**Latvia**

Ottensten Latvia SIA
Ciekurkalna Prima Gara Linija 11,
LV-1026 Riga, Latvia
Phone: 371-23-68625, Fax: 371-75-56748

**Lithuania**

UAB Ottensten Lietuva
Savanoriu pr.180, LT-2600 Vilnius, Lithuania
Phone/Fax: 370-2651602

**Netherlands**

SMC Pneumatics BV
Postbus 308, 1000 AH Amsterdam
Phone: 020-5318888, Fax: 020-5318880

**Norway**

SMC Pneumatics (Norway) A/S
Wollsveien 13 C, granfos Noeringspark
N-134 Lysaker, Norway
Phone: 22 99 6036, Fax: 22 99 6103

**Poland**

Semac Co., Ltd.
PL-05-075 Wesola k/Warszaway, ul. Wspolna 1A
Phone: 022-6131847, Fax: 022-613-3028

**Portugal**

SMC España (Sucursal Portugal), S.A.
Rua de Engº Ferreira Dias 452, 4100 Porto
Phone: 02-610-89-22, Fax: 02-610-89-36

**Romania**

SMC Romania srl
Vasile Stroescu 19, Sector 2, Bucharest
Phone: 01-210-1354, Fax: 01-210-1680

**Russia**

SMC Pneumatik LLC
Centrako Business Centre 103,
Bolshoy Prospect V.O., 199106 St. Petersburg
Phone: 812-1195131, Fax: 812-1195129

**Slovakia**

SMC Slovakia s.r.o.
Pribinova ul. C. 25, 819 02 Bratislava
Phone: 0-563 3548, Fax: 07-563 3551

**Slovenia**

SMC Slovenia d.o.o.
Grajski trg 15, 8360 Zuzemberk
Phone: 068-88 044 Fax: 068-88 041

**Spain**

SMC España, S.A.
Zuazobidea 14, Pol. Ind. Jundiz,
E-01015 Vitoria
Phone: 945-184 100, Fax: 945-184 124

**Sweden**

SMC Pneumatics Sweden A.B.
Ekhagsvägen 29-31, S-14105 Huddinge
Phone: 08-603 07 00, Fax: 08-603 07 10

**Switzerland**

SMC Pneumatik AG
Dorfstrasse 7, CH-8484 Weisslingen
Phone: 052-396-3131, Fax: 052-396-3191

**Turkey**

Entek Pnömatik San. ve Tic Ltd. Sti.
Perpa Tic. Merkezi Kat: 11 No: 1625,
TR-80270 Okmeydanı Istanbul
Phone: 0212-221-1512, Fax: 0212-220-2381

**UK**

SMC Pneumatics (UK) Ltd
Vincent Avenue, Crownhill,
Milton Keynes, MK8 0AN
Phone: 01908-563888 Fax: 01908-561185

OTHER SUBSIDIARIES WORLDWIDE:

ARGENTINA, AUSTRALIA, BOLIVIA, BRASIL, CANADA, CHILE, CHINA, HONG KONG, INDIA, MALAYSIA, MEXICO, NEW ZEALAND, PHILIPPINES, SINGAPORE, SOUTH KOREA, TAIWAN, THAILANDIA, USA, VENEZUELA

For more information, please contact your local SMC Regional Centre

SMC UK Regional Centres**BELFAST**

Tel:02890 778414 Fax:02890 778422
SMC Pneumatics (UK) Ltd
Northern Ireland Regional Centre
Suite 3, Shaftesbury House, Edgewater Road
Belfast
BT3 9JQ

BIRMINGHAM

Tel:01675 467177 Fax:01675 465073
SMC Pneumatics (UK) Ltd
Birmingham Regional Centre
24 The Courtyard, Gorseley Lane, Coleshill
Warwickshire
B46 1JA

BRISTOL

Tel:01179 522155 Fax:01179 522186
SMC Pneumatics (UK) Ltd
Bristol Regional Centre
5 East Gate Office Centre
East Gate Road, Eastville, Bristol
BS5 6XX

SMC UK Distributors**Birmingham**

JAMES LISTER
Tel: 0121 5803800
Fax: 0121 5535951

Blackburn

BLACKBURN PNEUMATIC SYSTEMS LTD
Tel: 01254 682232
Fax: 01254 682224

CRAWLEY

Tel:01293 614094 Fax:01293 614135
SMC Pneumatics (UK) Ltd
Crawley Regional Centre
9 Pelham Court, Pelham Place, Broadfield
Crawley
RH11 9AZ

CUMBERNAULD

Tel:01236 781133 Fax:01236 780611
SMC Pneumatics (UK) Ltd
Scottish Regional Centre
1 Carradaie Crescent,
Broadwood Business Park, Cumbernauld
Glasgow
G68 9LE

DROITWICH

Tel: 01905 774544 Fax: 01905 797343
SMC Pneumatics (UK) Ltd
Droitwich Regional Centre
Hampton Park, Hampton Lovett
Droitwich, Worcestershire
WR9 0NX

Bristol

APPLIED AUTOMATION
Tel: 0117 9827769
Fax: 0117 9235522

Bury St Edmunds

PNEUMATIC LINES
Tel: 01284 706239
Fax: 01284 761218

IPSWICH

Tel:01473 240040 Fax:01473 747707
SMC Pneumatics (UK) Ltd
Ipswich Regional Centre
Unit 6 & 7, Alpha Business Park
16-18 Whitehouse Road, Ipswich, Suffolk
IP1 5LT

MANCHESTER

Tel:0161 876 7371 Fax:0161 876 7372
SMC Pneumatics (UK) Ltd
Manchester Regional Centre
3 Modwen Road, Waters Edge Business Park
Ordsall Lane, Salford, Manchester
M5 3EZ

MILTON KEYNES

Tel: 01908 265247 Fax: 01908 262705
SMC Pneumatics (UK) Ltd
Vincent Avenue, Crownhill, Milton Keynes
MK8 0AN

Cardiff

WALES FLUID POWER
Tel: 02920 494551
Fax: 02920 481955

Plymouth

APPLIED AUTOMATION
Tel: 01752 343300
Fax: 01752 341161

NEWCASTLE

Tel:0191 487 2040 Fax:0191 487 2041
SMC Pneumatics (UK) Ltd
Newcastle Regional Centre
Unit B6, Marquis Court, Marquis Way
Team Valley Trading Estate, Gateshead
Tyne & Wear
NE11 0RU

POOLE

Tel:01202 732233 Fax:01202 737743
SMC Pneumatics (UK) Ltd
Poole Regional Centre
Unit 4, Acorn Business Centre, Ling Road
Poole, Dorset
BH12 4NZ

SHEFFIELD

Tel: 01909 565504 Fax: 01909 569717
SMC Pneumatics (UK) Ltd
Sheffield Regional Centre
Unit 4, North Anston Business Park
Houghton Road, North Anston, Sheffield
S25 4JJ