

order number: H01000A0087

Cable Terminator for Printed Circuits G7 (RG-316/U) solder/crimp

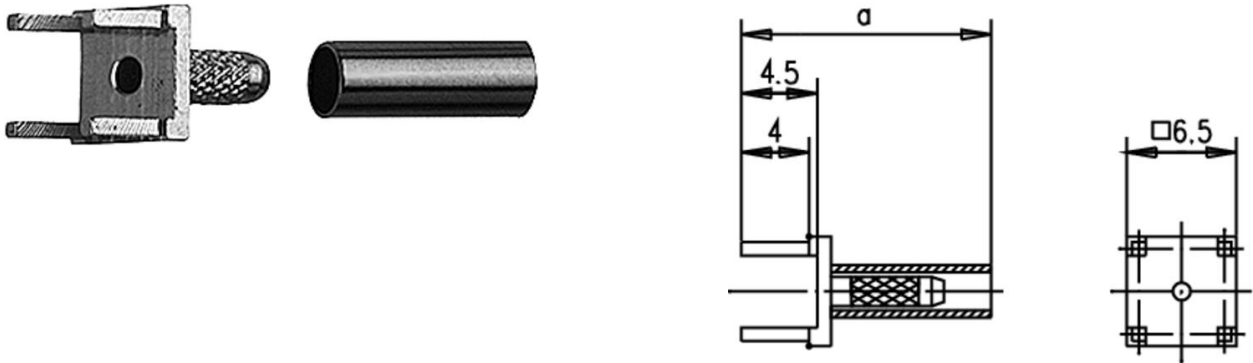

Technical Attributes	
Cable group; cable	G7 (RG-316/U)
Remarks	solder/crimp
Dimensions	a=14.8
Mount. dim.	Z25
Assembly	D0203
Crimp die	N01003A0009

Product description

Cable terminators are used for direct soldering of coax-cables onto printed circuits boards. Straight and angle types with 1, 2 or 4 pin terminations allow optimal solutions for various applications.