



2-Colour Display Type High-Precision Digital Pressure Switch



Types with one-touch fittings
are newly introduced.

Series ZSE30/ISE30



Straight type



Elbow type

2-color digital display allows you to choose the setting according to your application requirements. 4 different display settings are available.

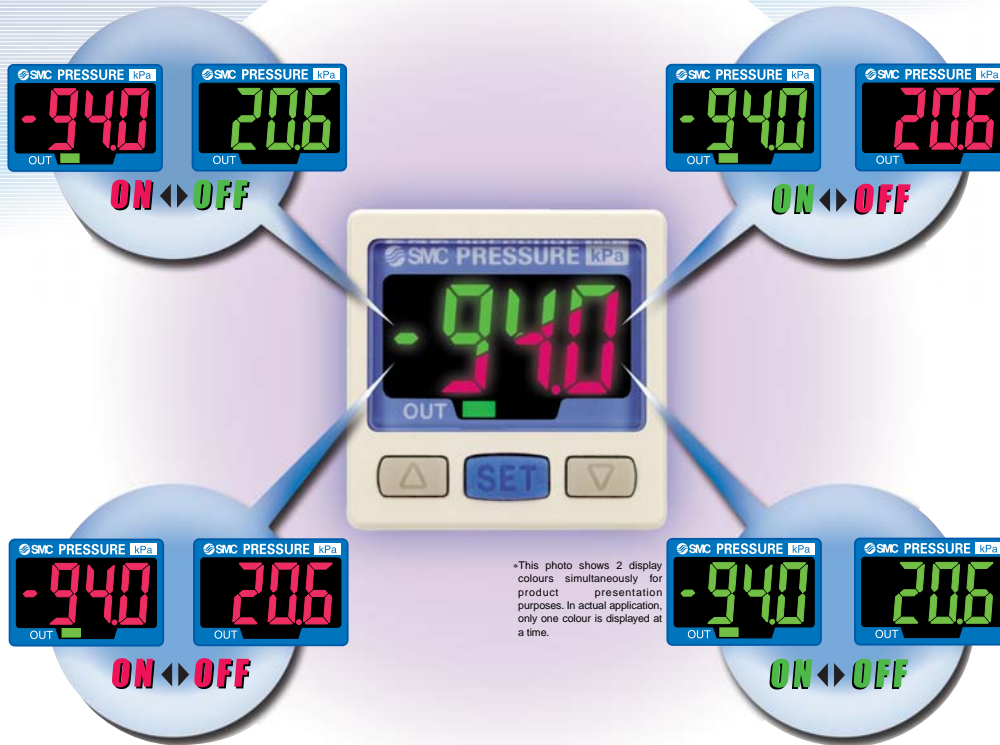

Abnormal conditions can be detected at a glance!

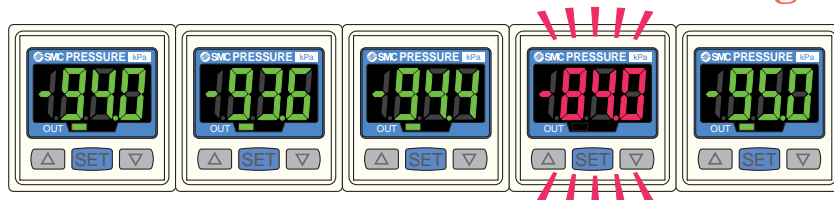

With one-touch fitting ($\varnothing 4$, $\varnothing 6$, $\varnothing 5/32''$, $\varnothing 1/4''$)

Reduced dimensions in piping direction

17.8 mm reduction*

Straight type

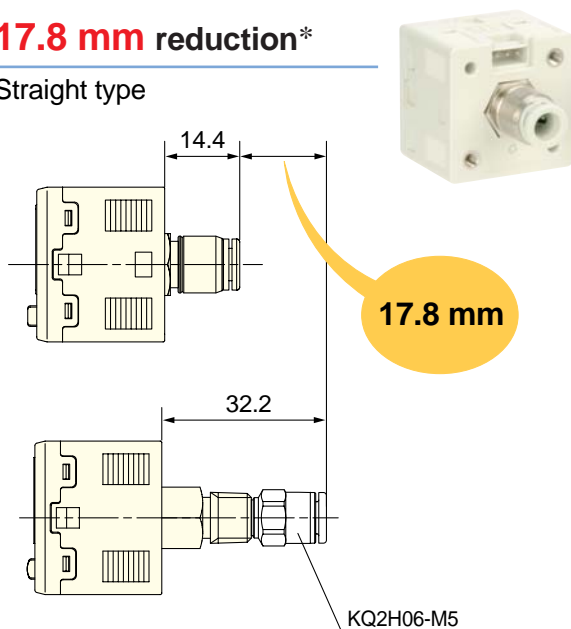

12.4 mm reduction*

Elbow type

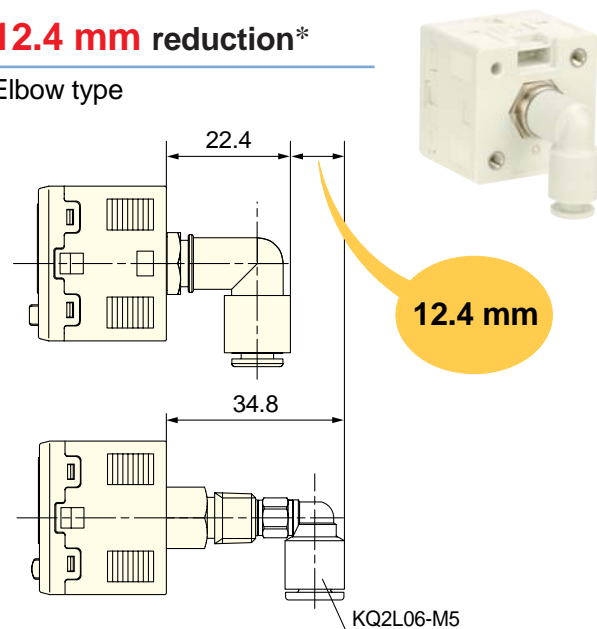

* Comparison when One-touch fittings (KQ2H06-M5 / KQ2L06-M5) are connected to the piping ports (M5)

Space-saving improvement

Economical use of space



Old Model
ZSE4E
ISE4E

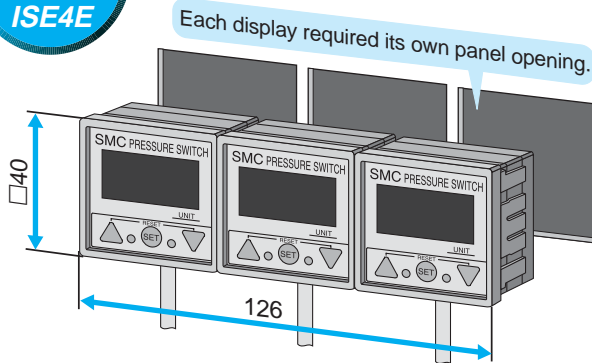

New Model
ZSE30
ISE30

Just one panel opening is required for stackable displays, which can be mounted either horizontally or vertically.

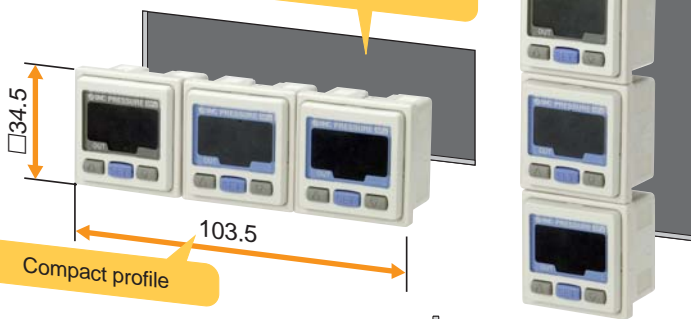

Applicable panel thickness is up to 6mm.

(Panel mounting)

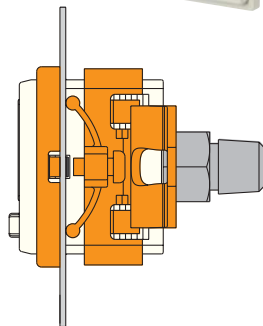

With analogue output

In addition to the conventional voltage output type (1 to 5 V)

Current output type (4 to 20 mA) is now available.

- Convenient when longer wiring is required
- Excellent noise resistance

Switches for vacuum and positive pressure can be easily distinguished.

The different display panel frame colours easily tell them apart.

Vacuum/Low pressure (ZSE30)

Positive pressure (ISE30)

Blue



Gray



Display calibration

Old Model

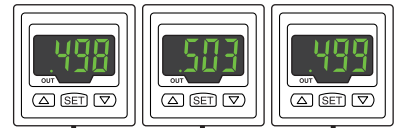

New Model

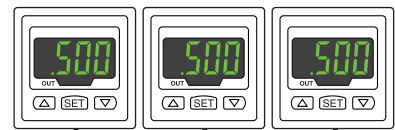

This function allows uniformity in the numbers displayed.

More user-friendly controls

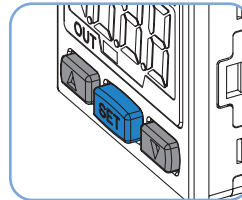

Raised rubber button controls are clearly set apart, simple to operate, soft to the touch.

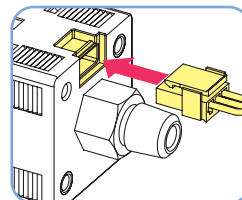

Plug-type connectors take the burden out of wiring work and maintenance.

High-precision resolution: 1/1000

Variations

	Vacuum/Low pressure ZSE30	Positive pressure ISE30
Rated pressure range	100 kPa 0 -100 kPa	1 MPa 0
Setting/Display resolution	0.2 kPa	0.001 MPa
Output	Switch output Analogue output	NPN/PNP open collector (1 output) Voltage output: 1 to 5 V; Current output: 4 to 20 mA
Current consumption	45 mA or less (70 mA or less for current output)	
Option	Panel mount/Bracket	

2-Colour Display Type High-Precision Digital Pressure Switch



Series ZSE30/ISE30

How to Order

Option 1

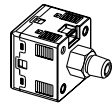
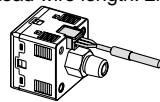
Nil	Without lead wire 
L	Lead wire with connector (Lead wire length: 2m) 

For positive pressure

ISE30 — 01 — 25 — M — —

For vacuum/low pressure

ZSE30 — 01 — 25 — M — —

Piping specification

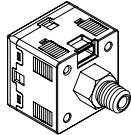
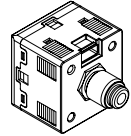
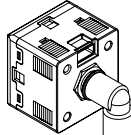
01	R 1/8 (with M5 female thread)	
T1	NPT 1/8 (with M5 female thread)	
C4H	ø4 one-touch fitting ø5/32" one-touch fitting	Straight type 
C6H	ø6 one-touch fitting	
N7H	ø1/4" one-touch fitting	
C4L	ø4 one-touch fitting ø5/32" one-touch fitting	Elbow type 
C6L	ø6 one-touch fitting	
N7L	ø1/4" one-touch fitting	

Output specification

25	NPN output
65	PNP output
26	1 to 5 V output
28	4 to 20 mA output

Option 2

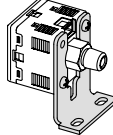
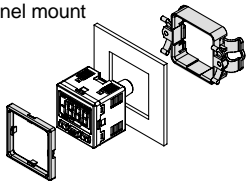
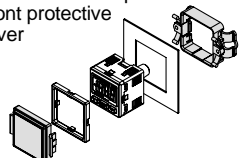
Nil	None
A	Bracket 
B	Panel mount 
D	Panel mount adapter + Front protective cover 

Optional Part Nos.

When optional parts are required separately, use the following part numbers to place an order.

Option	Part no.	Note
Lead wire with connector	ZS-27-A	Lead wire length: 2 m
Bracket	ZS-27-B	With mounting screws (M3 x 5L: 2 pcs.)
Panel mount adapter	ZS-27-C	With M3 x 8L (2 pcs.)
Panel mount adapter + Front protective cover	ZS-27-D	With M3 x 8L (2 pcs.)

Unit specification

Nil	With unit switching function
M	Fixed SI until (International System of Units) ^{Note)}

Note) Fixed units:
For vacuum/Low pressure: kPa
For positive pressure: MPa

Specifications



		ZSE30 (Vacuum/Low pressure)	ISE30 (Positive pressure)
Rated pressure range		-100.0 to 100.0 kPa	0.000 to 1.000 MPa
Regulating pressure range		-101.0 to 101.0 kPa	-0.100 to 1.000 MPa
Proof pressure		500 kPa	1.5 MPa
Min. regulating unit		0.2 kPa	0.001 MPa
Fluid		Air, Inert gas, Non-flammable gas	
Power supply voltage		12 to 24 VDC, Ripple (p-p) 10% or less (with power supply polarity protection)	
Current consumption		45 mA or less (at no load)	
Switch output <small>Note 1)</small>		NPN or PNP open collector output: 1 output	
		Max. load current 80 mA	
		Max. applied voltage 30 V (with NPN output)	
		Residual voltage 1 V or less (with load current of 80 mA)	
		Response time 2.5 ms or less (Response time selections with anti-chattering function: 20 ms, 160 ms, 640 ms, 1280 ms)	
		Short circuit protection With short circuit protection	
Repeatability		±0.2% F.S. ±2 digit or less	±0.2% F.S. ±1 digit or less
Analogue output	Voltage output <small>Note 2)</small>	Output voltage: 1 to 5 V ±2.5% F.S. or less (with rated pressure range) Linearity: ±1% F.S. or less, Output impedance: Approx. 1 kΩ	
	Current output <small>Note 3)</small>	Output current: 4 to 20 mA ±2.5% F.S. or less (with rated pressure range) Linearity: ±1% F.S. or less Maximum load impedance: 300 Ω with power supply voltage of 12 V; 600 Ω with power supply voltage of 24 V Minimum load impedance: 50 Ω	
Hysteresis	Hysteresis mode	Adjustable (can be set from 0)	
	Window comparator mode		
Display		3 1/2 digit, 7-segment indicator, 2-colour display (red and green) Sampling cycle: 5 times/s	
Display accuracy		±2% F.S. ±2 digit (at 25°C ambient temperature)	±2% F.S. ±1 digit (at 25°C ambient temperature)
Indication light		Light up when output is ON (Green)	
Temperature characteristics		±2% F.S. or less (based on 25°C)	
Environmental resistance	Enclosure	IP40	
	Operating temperature range	Operating: 0 to 50°C, Stored: -10 to 60°C (with no freezing or condensation)	
	Operating humidity range	Operating and stored: 35 to 85%RH (with no condensation)	
	Withstand voltage	1000 VAC for 1 min. between live parts and enclosure	
	Insulation resistance	50 MΩ or more between live parts and enclosure (at 500 VDC)	
	Vibration resistance	10 to 150 Hz, 1.5 mm or 20 m/s ² amplitude in X, Y, Z directions for 2 hours each	
	Impact resistance	100 m/s ² in X, Y, Z directions 3 times each	
Standard		Compliant with CE Marking and UL (CSA) standards	

Note 1) When switch output is selected, analogue output is not available.

Note 2) When voltage output is selected, a simultaneous selection of switch output and current output is not available.

Note 3) When current output is selected, a simultaneous selection of switch output and voltage output is not available.

Piping Specification

Part	01	T1	C4H	C6H	N7H	C4L	C6L	N7L
Port size	R1/8 M5	NPT1/8 M5	-	-	-	-	-	-
	One-touch fitting Straight type	-	-	ø4 mm ø5/32 inch	ø6 mm	ø1/4 inch	-	-
	One-touch fitting Elbow type	-	-	-	-	ø4 mm ø5/32 inch	ø6 mm	ø1/4 inch
Wetted part material		Sensor pressure receiving area: silicon, piping port: C3602 (electroless nickel plated), O-ring: HNBR						
		O-ring: NBR			O-ring: NBR, fitting: PBT			
Weight	With lead wire with connector (2 m)	81 g	76 g		78 g			
	Without lead wire with connector	43 g	38 g		40 g			

Setting

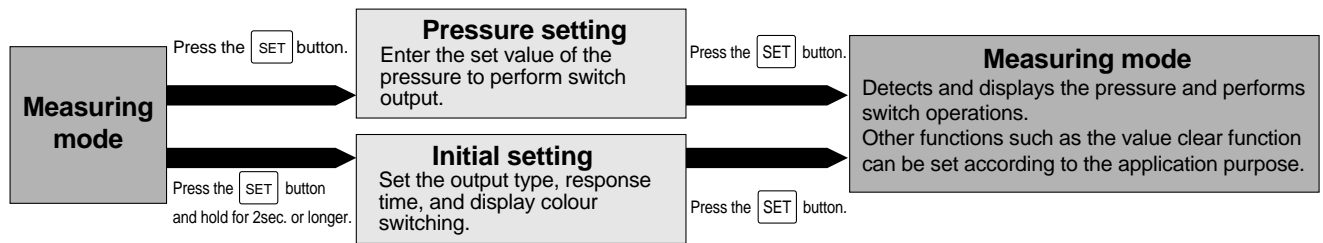

Initial Setting

Initial setting mode

Press and hold the SET button for 2 seconds or longer. Display monitor will be per Figure A below, and the switch will now be in the display colour setting mode.

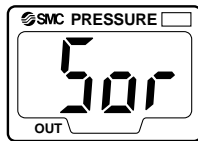
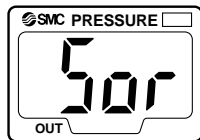

Figure A

If the unit specification indicated at the time of ordering is "M", the fixed SI unit will be used. If it is Nil, refer to "Unit Switching Function" on page 5.

1. Display colour setting

Select the colour for LCD display. Press the ΔUP or ∇DOWN button to choose a display colour.



ON: Red



ON: Green

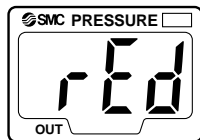

ON/OFF: Red

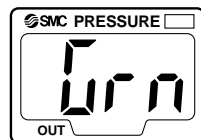

ON/OFF: Green

Press the SET button to set the colour and proceed to the operating mode setting.

If the analogue output is set, press the ΔUP or ∇DOWN button and select the desired display colour from Grn (Green) or rEd (Red). Press the SET button to exit this mode and return to the measuring mode.

2. Operating mode setting

This mode will let you select the switch operating mode. While the current operating mode is displayed, press the ΔUP or ∇DOWN button to select a newly desired operating mode.

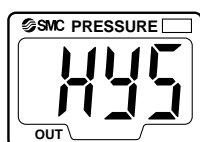

Hysteresis mode

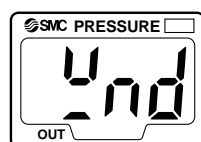

Window comparator mode

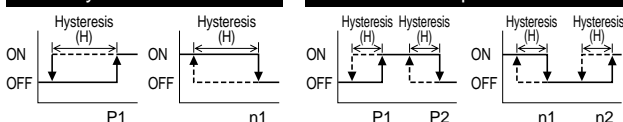

(Standard: Factory setting) (Reversed)

(Standard: Factory setting) (Reversed)

Press the SET button to set the mode and proceed to the output type setting.

3. Output type setting

The type of switch output can be set arbitrarily. While the current output type is displayed, press the ∇DOWN button to switch between normally open *no* and normally closed *nc*.

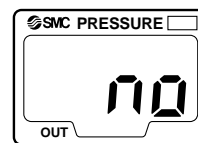

Normally open

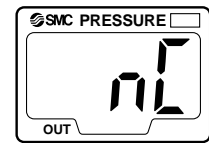

Normally closed

Press the SET button to set the output type and proceed to the response time setting.

4. Response time setting

The switch output response time can be set arbitrarily. Chattering can be prevented with a response time setting. While the current response time is displayed, press the ΔUP or ∇DOWN button to select a new response time.

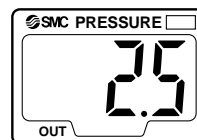

2.5 ms

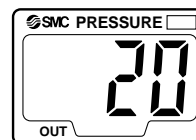

20 ms

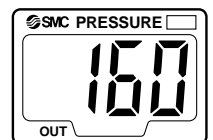

160 ms

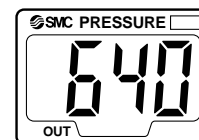

640 ms



1280 ms

Press the SET button to set the response time and proceed to the auto preset setting.

If the operating mode is the window comparator mode, press the SET button to return to the measuring mode.

5. Auto preset setting

This function stores the measuring pressure that is set during the auto preset mode as a basic value.

While the current setting is displayed, press the ΔUP or ∇DOWN button to select it as an auto preset setting.

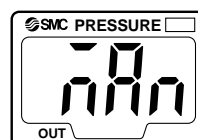

Manual

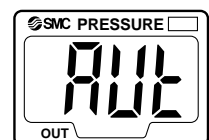

Auto

Press the SET button to set the auto preset and return to the measuring mode.

Pressure setting

Manual setting

Press the SET button in the measuring mode to display the set value. P_{-} and the current set value blink alternately.

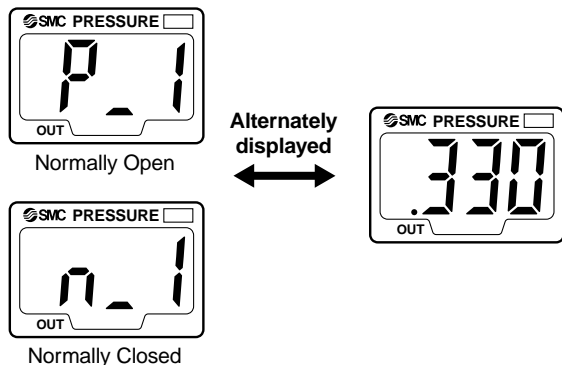

Press the SET button to display the next set value. Press the Δ UP or ∇ DOWN button to change the value. (Refer to "How to Set Value" on the lower right hand corner of this page.)

Hysteresis mode

In this mode, hysteresis (H) and the set value for hysteresis are displayed alternately after setting P1. Press the SET button to return to the normal measuring mode. Press the Δ UP or ∇ DOWN button to change the value. (Refer to "How to Set Value" below right.)

Window comparator mode

In this mode, P2 and the current set value are displayed alternately after setting P1. Press the SET button to display the next set value (H: hysteresis). Press the Δ UP or ∇ DOWN button to change the value. (Refer to "How to Set Value" at right.)

Next, H and the set value for hysteresis will be displayed alternately. Press the SET button to return to the normal measuring mode. Press the Δ UP or ∇ DOWN button to change the value. (Refer to "How to Set Value" at right.)

Pressure set value can be verified without holding or stopping the switch output operation.

Auto preset setting

1. Auto preset preparation mode

While in the measuring mode, press the SET button to activate the auto preset preparation mode, and RP_1 will be displayed. Proceed to prepare the devices to perform the pressure setting. While RP_1 is still displayed, press both the Δ UP and ∇ DOWN buttons simultaneously to return to the measuring mode.

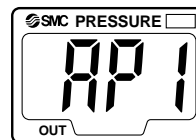

2. Auto preset setting

Press the SET button to activate the mode to execute auto preset functions. When RL is displayed, start the system operation and change the pressure. The set value will be automatically detected and stored.

While RL is still displayed, press the SET button to complete the setting and return to the normal measuring mode.

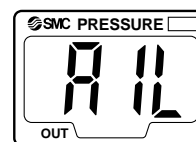

How to Set Value

To enter a value such as the one for pressure setting:

1. Press the Δ UP or ∇ DOWN button to change the set value. The first digit blinks.



1st digit

2. Press the Δ UP or ∇ DOWN button to set the value arbitrarily. (If there is no button operation for more than 10 seconds, the current value will be automatically set and the function will return to the set value display mode.)

3. With every push of the SET button, the next (higher) digit blinks.



2nd digit



3rd digit

When the left-most digit is zero, "r" or "j" will blink. If the SET button is pressed while the left-most digit is blinking, the right-most digit will now blink.



4. Press and hold the SET button for 1 second or longer to return to the set value display mode.

Setting

Function setting

Display calibration

During measuring mode, press the SET and ∇ DOWN buttons simultaneously and hold for 2 seconds or longer. F5L and current measured value will be displayed.

Press the Δ UP or ∇ DOWN button to change the set value. If there is no button operation for more than 2 seconds after changing the set value, the display mode returns to displaying F5L and the current measured value.

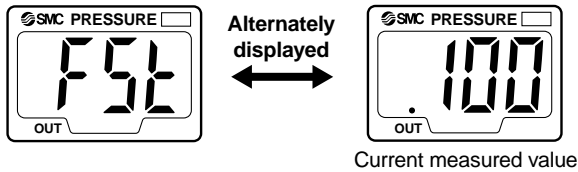

Press the SET button to display the adjusted value (percent). The adjusted value and F5L will be alternately displayed.

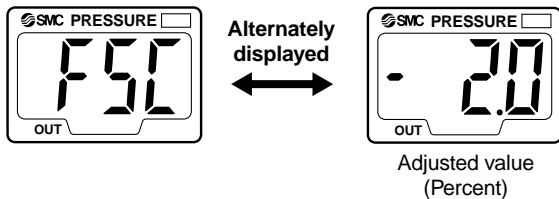

Press the SET button to return to the normal measuring mode.

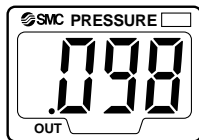

This function eliminates slight differences in the output values and allows uniformity in the numbers displayed.

Displayed values of the pressure sensor can be calibrated to within $\pm 5\%$ for Series ISE and $\pm 2.5\%$ for Series ZSE.

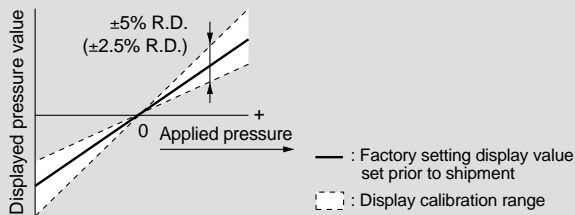

Note) When the display calibration function is used, the regulating pressure value may change ± 1 digit.

Peak/Bottom hold function

This function constantly detects and updates the maximum and minimum pressure values and allows to hold the display value. To use a peak hold function, press and hold the Δ UP button for 1 second or longer. The maximum pressure value is held and blinks repeatedly. Press and hold the Δ UP button again for 1 second or longer to release this function and return to the measuring mode.

To use a bottom hold function, press the ∇ DOWN button for 1 second or longer. The minimum pressure value is held and blinks repeatedly. Press and hold ∇ DOWN button again for 1 second or longer to release this function and return to the measuring mode.

Key lock function

This function prevents incorrect operations such as changing the set value accidentally. Press the SET button and hold for 4 seconds or longer to display the current Loc or Unl setting. Press the Δ UP or ∇ DOWN button to select the setting and set this function with the SET button. Use the Loc mode to avoid accidental button operation. To release a key lock function, press the SET button and hold for 4 seconds or longer to display the current setting, and select the Unl mode.

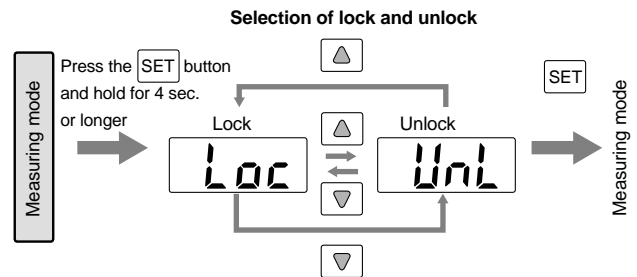

Zero out (Zero ADJ) function

This function clears and resets the displayed value as long as the measuring pressure is within ± 70 digits of the atmospheric pressure.

(Due to individual product differences, the setting range varies $\pm 10\%$ F.S.)

This function is effective in detecting pressure fluctuations that exceed a certain amount without being affected by the supply pressure. Press and hold the Δ UP and ∇ DOWN buttons simultaneously to reset the display. Release the buttons to return to the measuring mode.

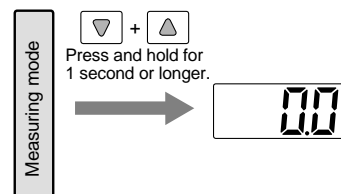

Unit Conversion Function

When not selecting "M" for unit specification

Desired display unit can be selected.

Press the Δ UP or ∇ DOWN button to switch the unit, and the set value is automatically converted.

The conversion order is: Pa \leftrightarrow GF \leftrightarrow bAr \leftrightarrow PSi \leftrightarrow inHg \leftrightarrow mmHg

Press the SET button to set the unit and proceed to the display colour setting.

For vacuum/low pressure Pa \leftrightarrow kgf/cm² \leftrightarrow bar \leftrightarrow psi \leftrightarrow inchHg \leftrightarrow mmHg

For positive pressure MPa \leftrightarrow kgf/cm² \leftrightarrow bar \leftrightarrow psi

Indication of units

Displayed units	ISE30	ZSE30
Pa	0.001 MPa	0.2 kPa
kgf/cm ²	0.01	0.002
bar	0.01	0.002
psi	0.2	0.05
mmHg	—	2
inchHg	—	0.2

Description

Indication light (Green)

Displays the switch operation status.

▲UP button

Use this button to change the mode or increase the ON/OFF set value. It also allows you to switch to the peak value display mode.

SET button

Use this button to switch the mode and set the set value.



LCD Display

Displays the current pressure condition, setting mode conditions, selected display unit, and error codes. A display colour type can be selected from either a single colour display with red or green, or 2-colour display in which green and red are switched according to the output.

▼DOWN button

Use this button to change the mode or decrease the ON/OFF set value. It also allows you to switch to the bottom value display mode.

Error Correction

Take the following corrective solutions when errors occur.

Error description	LCD display	Condition	Solution
Over-current error	Er1	Load current of switch output is more than 80 mA.	Shut off the power supply. After eliminating the output factor that caused the excess current, turn the power supply back on.
Residual pressure error	Er3	Pressure is applied during the zero out operation as follows: When the switch for positive pressure is used: ± 0.071 MPa or more. When the switch positive pressure is used: ± 7.1 kPa or more. After displaying for 3 seconds, it will return to the measuring mode. Due to the individual product difference, the setting range varies $\pm 10\%$ F.S.	Bring the pressure back to atmospheric pressure and try using the zero out function.
Applied pressure error	HHH	Supply pressure exceeds the maximum regulating pressure.	Reduce/Increase supply pressure to within the regulating pressure range.
	LLL	Supply pressure is below the minimum regulating pressure.	
System error	Er4	Internal data error	Shut off the power supply. Turn the power supply back on. If the power should not come back on, please contact SMC for an inspection.
	Er6	Internal data error	
	Er7	Internal data error	
	Er8	Internal data error	

Internal Circuit and Wiring Examples

-25

NPN open collector output

Maximum 30 V, 80 mA

Residual voltage:
1 V or less

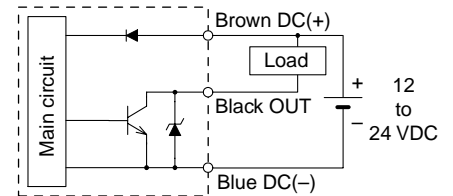

-26

Analogue output type

1 to 5 V ($\pm 2.5\%$ F.S.)

Output impedance:
1 k Ω

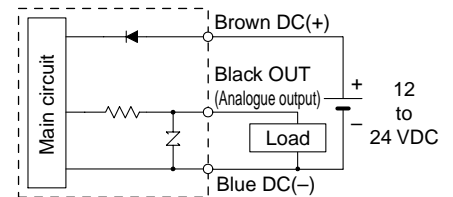

-28

Analogue output type

4 to 20 mA ($\pm 2.5\%$ F.S.)

Maximum load impedance:

Power supply voltage 12 V: 300 Ω

Power supply voltage 24 V: 600 Ω

Minimum load impedance: 50 Ω

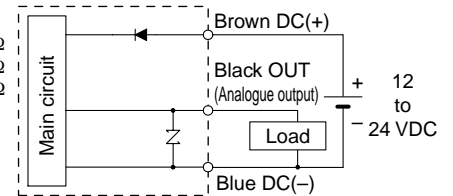

-65

PNP open collector

Maximum 80 mA

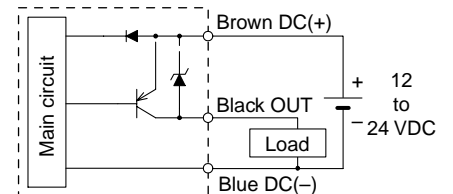

Series ZSE30/ISE30

Dimensions

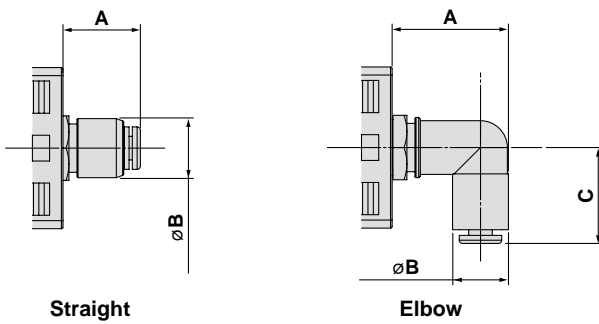
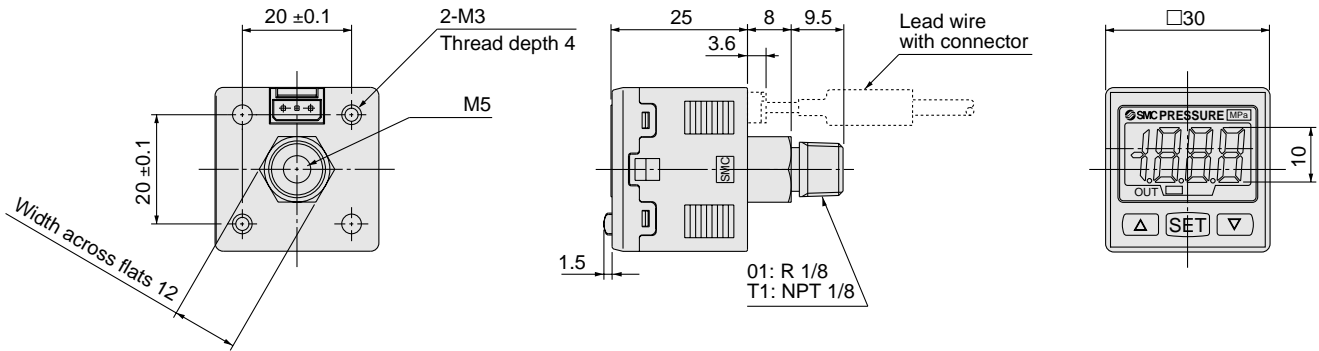

Straight

Elbow

With one-touch fitting

(mm)

One-touch fitting size	Straight		Elbow		
	A	B	A	B	C
ø4, ø5/32"	14.4	11.2	20	10.4	18
ø6			22.4	12.8	20
ø1/4"			22.8	13.2	20.5

With bracket

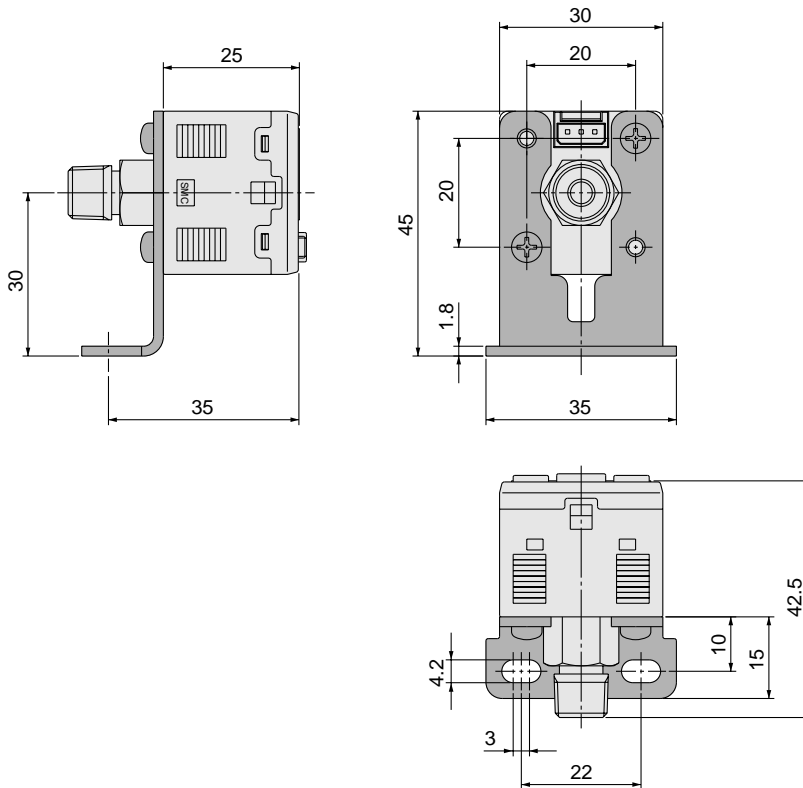

Dimensions

Panel mount

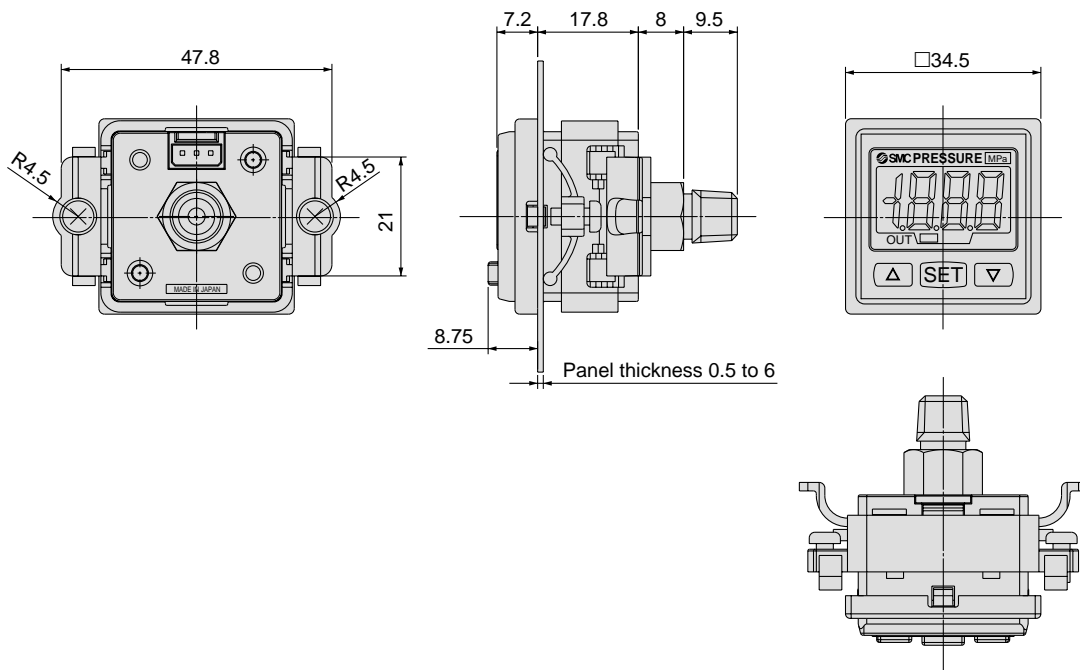

Panel mount adapter + Front protective cover

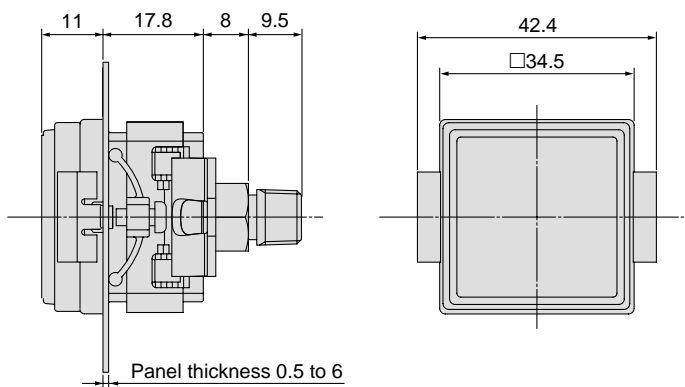

Series ZSE30/ISE30

Dimensions

Panel fitting dimension

1-pc. mounting

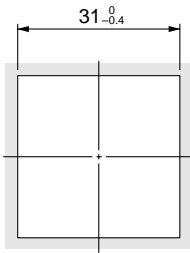

Multiple (2 pcs. or more) horizontal mounting

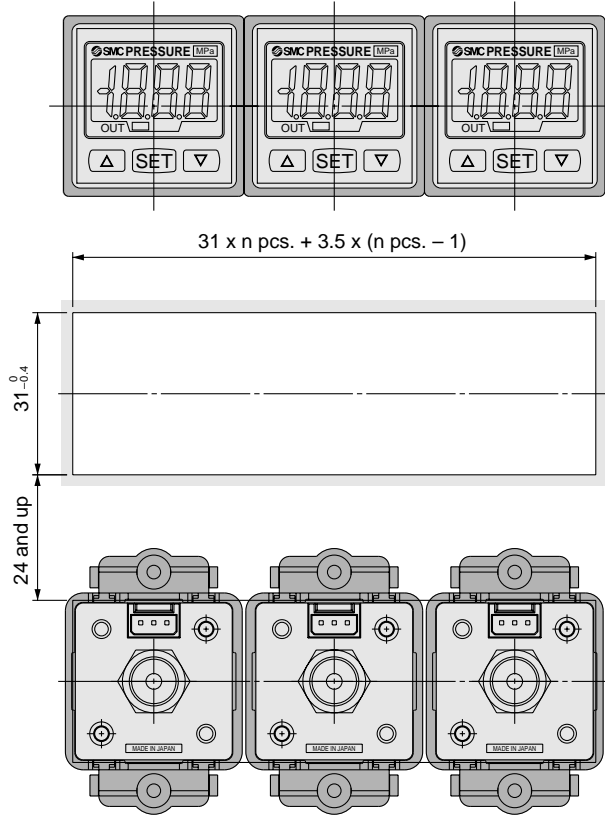

Multiple (2 pcs. or more) vertical mounting

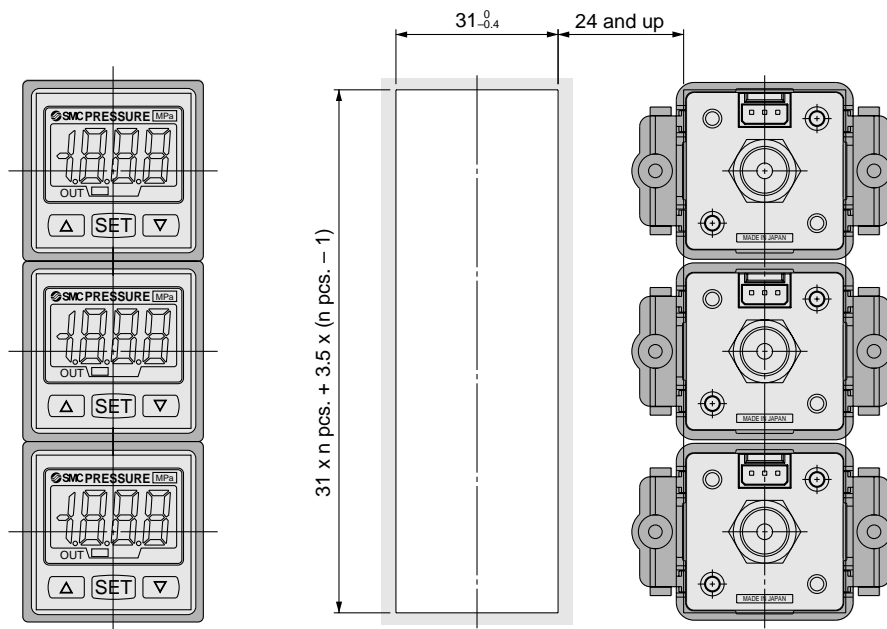



Series ZSE30/ISE30

Safety Instructions

These safety instructions are intended to prevent a hazardous situation and/or equipment damage. These instructions indicate the level of potential hazard by a label of "**Caution**", "**Warning**", or "**Danger**". To ensure safety, be sure to observe ISO 4414 Note 1), JIS B 8370 Note 2) and other safety practices.

⚠ Caution : Operator error could result in injury or equipment damage.

⚠ Warning : Operator error could result in serious injury or loss of life.

⚠ Danger : In extreme conditions, there is a possible result of serious injury or loss of life.

Note 1) ISO 4414: Pneumatic fluid power – General Rules for Pneumatic Equipment

Note 2) JIS B 8370: Pneumatic system axion

⚠ Warning

1. The compatibility of pneumatic equipment is the responsibility of the person who designs the pneumatic system or decides its specifications.

Since the products specified here are used in various operating conditions, their compatibility with the specific pneumatic system must be based on specifications or after analysis and/or tests to meet your specific requirements. The expected performance and safety assurance will be the responsibility of the person who has determined the compatibility of the system. This person should continuously review the suitability of all items specified, referring to the latest catalog information with a view to giving due consideration to any possibility of equipment failure when configuring a system.

2. Only trained personnel should operate pneumatically operated machinery and equipment.

Compressed air can be dangerous if handled incorrectly. Assembly, handling or maintenance of pneumatic systems should be performed by trained and experienced operators.

3. Do not service machinery/equipment or attempt to remove components until safety is confirmed.

1. Inspection and maintenance of machinery/equipment should only be performed after confirmation of safe locked-out control positions.
2. When equipment is to be removed, confirm the safety process as mentioned above. Cut the supply pressure for this equipment and exhaust all residual compressed air in the system.
3. Before machinery/equipment is restarted, take measures to prevent shooting-out of cylinder piston rod, etc. (Bleed air into the system gradually to create back pressure.)

4. Contact SMC if the product is to be used in any of the following conditions:

1. Conditions and environments beyond the given specifications, or if product is used outdoors.
2. Installation on equipment in conjunction with atomic energy, railway, air navigation, vehicles, medical equipment, food and beverages, recreation equipment, emergency stop circuits, press applications, or safety equipment.
3. An application which has the possibility of having negative effects on people, property, or animals, and therefore requires special safety analysis.



Series ZSE30/ISE30 Pressure Switch Precautions 1

Be sure to read before handling. Refer to pages 10 through 12 for safety instructions and pressure switch precautions, and to page 13 for specific product precautions.

Design and Selection

⚠ Warning

1. Operate the switch only within the specified voltage.

Use of the switch outside the range of the specified voltage can cause not only malfunction and damage of the switch but also electrocution and fire.

2. Do not exceed the maximum allowable load specification.

A load exceeding the maximum load specification can cause damage to the switch or shorten its operating life span.

3. Do not use a load that generates surge voltage.

Although surge protection is installed in the circuit at the output side of the switch, damage may still occur if a surge is applied repeatedly. When a surge generating load such as a relay or solenoid is directly driven, use a type of switch with a built-in surge absorbing element.

4. Since the type of applicable fluid varies depending on the product, be sure to verify the specifications.

The switches do not have an explosion proof rating. To prevent a possible fire hazard, do not use with flammable gases or fluids.

5. Operate the switch within the regulating pressure range and maximum operating pressure.

Malfunction can occur if the pressure sensor is used outside the regulating pressure range, and the sensor may be permanently damaged if used at a pressure that is above the maximum operating pressure.

Mounting

⚠ Warning

1. If the equipment is not operating properly, do not continue to use it.

Connect air and power after installation, repairs, or modifications, and verify proper installation. The switch should be checked for proper operation and possible leaks.

2. Mount switches using the proper tightening torque.

When a switch is tightened beyond the specified tightening torque, the mounting screws, mounting bracket, or switch may be damaged. On the other hand, tightening below the specified tightening torque may cause the installation screws to come loose during operation.

Nominal thread sizes	Tightening torque
M5	1/6 rotation after tightening by hand
R 1/8, NPT 1/8	7 to 9 N·m

3. Apply wrench only to the metal part of the main housing when installing the pressure switch onto the system piping.

Do not apply a wrench to the resin part as this may damage the switch.

Wiring

⚠ Warning

1. Verify the colour and terminal number when wiring.

Incorrect wiring can cause the switch to be damaged and malfunction. Verify the colour and the terminal number in the instruction manual when wiring.

2. Avoid repeatedly bending or stretching the lead wire.

Repeatedly applying bending stress or stretching force to the lead wire will cause it to break. If you believe the lead wire is damaged and likely to cause malfunctions, replace it.

3. Confirm proper insulation of wiring.

Make sure that there is no faulty wiring insulation (contact with other circuits, ground fault, improper insulation between terminals, etc.). Damage may occur due to excess current flow into a switch.

Operating Environment

⚠ Warning

1. Never use in the presence of explosive gases.

The switches do not have an explosion proof rating. Never use in the presence of an explosive gas as this may cause a serious explosion.

Maintenance

⚠ Warning

1. Perform periodic inspections to ensure proper operation of the switch.

Unexpected malfunctions may cause possible danger.

2. Take precautions when using the switch for an interlock circuit.

When a pressure switch is used for an interlock circuit, devise a multiple interlock system to prevent trouble or malfunctioning. Verify the operation of the switch and interlock function on a regular basis.



Series ZSE30/ISE30 Digital Pressure Switch Precautions 1

Be sure to read before handling. Refer to pages 10 through 12 for safety instructions and pressure switch precautions, and to page 13 for specific product precautions.

Selection

⚠ Warning

1. Monitor the internal voltage drop of the switch.

When operating below a specified voltage, it is possible that the load may be ineffective even though the pressure switch function is normal. Therefore, the formula below should be satisfied after confirming the minimum operating voltage of the load.

$$\text{Supply voltage} - \text{Internal voltage drop of switch} > \text{Minimum operating voltage of load}$$

⚠ Caution

1. Data of the digital pressure switch will be stored even after the power is turned off.

Input data (set pressure, etc.) will be stored in EEPROM so that the data will not be lost after the pressure switch is turned off. (Data will be stored for up to 100,000 hours after the power is turned off.)

Mounting

⚠ Warning

1. Operation

Refer to the instruction manual for the operation of the digital pressure switch.

2. Do not touch the LCD indicator.

Do not touch the LCD indicator face of the pressure switch during operation. Static electricity can change the readout.

3. Pressure port

Do not introduce any wire or similar object to a pressure port as this may damage the pressure sensor and cause a malfunction.

Wiring

⚠ Warning

1. Do not wire in conjunction with power lines or high voltage lines.

Wire separately from power lines and high voltage lines, avoiding wiring in the same conduit with these lines. Control circuits including switches may malfunction due to noise from these other lines.

2. Do not allow loads to short circuit.

Although digital pressure switches indicate excess current error if loads are short circuited, all incorrect wiring connections cannot be protected. Take precautions to avoid incorrect wiring.

As for other pressure switches, the switches will be instantly damaged if loads are short circuited. Take special care to avoid reverse wiring between the brown power supply line and the black output line.

3. Connect a DC(–) wire (blue) as close as possible to the DC power supply GND terminal.

Connecting the power supply away from the GND terminal can cause malfunctions due to noise from devices that are connected to the GND terminal.

4. Do not attempt to insert or pull the pressure sensor or its connector when the power is on. A switch output malfunction may occur.

Air Supply

⚠ Warning

1. Use the switch within the specified fluid and ambient temperature range.

Ambient and fluid temperature operation is as follows:

Digital pressure switches: 0° to 50°C

Other pressure switches: 0° to 60°C

Take measures to prevent moisture from freezing in circuits when below 5°C, since this may cause damage to the O-ring and lead to a malfunction. The installation of an air dryer is recommended for eliminating condensate and moisture. Never use the switch in an environment where there are drastic temperature changes even when these temperatures are operated within the specified temperature range.

2. Vacuum switch

An instant pressure pulse of up to 500kPa (0.5MPa) (at the time of vacuum release) will not affect the performance of the switch. However, a constant pressure of 200kPa (0.2MPa) or more should be avoided.

Operating Environment

⚠ Warning

1. Do not use in an area where surges are generated.

When there are units that generate a large amount of surge in the area around pressure switches (e.g., solenoid type lifters, high frequency induction furnaces, motors), this may cause deterioration or damage to the switches' internal circuitry. Avoid and protect against sources of surge generation and crossed lines.

2. Operating environment

In general, the digital pressure switches featured here are not dust or splashproof. Avoid using in an environment where the likelihood of splashing or spraying of liquids (water, oil, etc.) exists. If used in such an environment, use a dustproof and splashproof type switch.

Maintenance

⚠ Caution

1. Cleaning of the switch body

Wipe off dirt with a soft cloth. If dirt does not come off easily, use a neutral detergent diluted with water to dampen a soft cloth. Wipe the switch only after squeezing the excess water out of the dampened cloth. Then finish off by wiping with a dry cloth afterwards.



Series ZSE30/ISE30 Specific Product Precautions 1

Be sure to read before handling. Refer to pages 10 through 12 for safety instructions and pressure switch precautions.

Handling

⚠ Warning

1. Do not drop, bump, or apply excessive impacts (980m/s²) while handling. Although the body of the sensor may not be damaged, the internal parts of the sensor could be damaged and lead to a malfunction.
2. The tensile strength of the cord is 35N. Applying a greater pulling force on it can cause a malfunction. When handling, hold the body of the sensor — do not dangle it from the cord.
3. Do not exceed the screw-in torque of 7 to 9 N·m when installing piping. Exceeding this value may cause malfunctioning of the sensor.
4. Do not use pressure sensors with corrosive and/or flammable gases or liquids.
5. Allow a sufficient margin of tube length in piping in order to prevent application of torsional, tensile or moment load to the tubes and fittings.
6. When a brand of tubing other than SMC is used, make sure that the tolerance of the tube's O.D. satisfies the following specifications.
 - 1) Nylon tubing: ± 0.1 mm or less
 - 2) Soft nylon tubing: ± 0.1 mm or less
 - 3) Polyurethane tubing: $+0.15$ mm or less, -0.2 mm or less
7. The applicable fluid is air. Please consult SMC if the switch is to be used with other types of fluids.

Connection

⚠ Warning

1. Incorrect wiring can damage the switch and cause a malfunction or erroneous switch output. Connections should be done while the power is turned off.
2. Do not attempt to insert or pull the pressure sensor or its connector when the power is on. A switch output malfunction may occur.
3. Wire separately from power lines and high voltage lines, avoiding wiring in the same conduit with these lines. Malfunctions may occur due to noise from these other lines.
4. If a commercial switching regulator is used, make sure that the F.G. terminal is grounded.

Operating Environment

⚠ Warning

1. Our pressure switches are CE marked; however, they are not equipped with surge protection against lightning. Lightning surge counter measures should be applied directly to system components as necessary.
2. Our pressure switches do not have an explosion proof rating. Never use in the presence of an explosive gas as this may cause a serious explosion.
3. Do not use in an environment where static electricity can cause problems, otherwise system failure or malfunction may result.

Mounting

⚠ Caution

1. Mounting with panel mount adapter

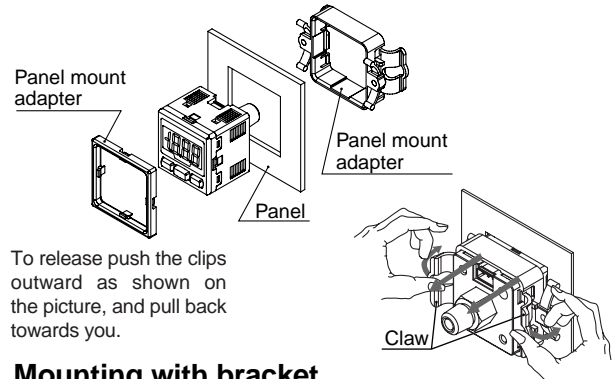

2. Mounting with bracket

Mount a bracket to the body using two M3 x 5L mounting screws and install on piping with hexagon socket head cap screws. The switch can be installed horizontally depending on the installation location.

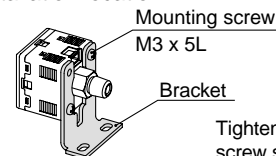

Tightening torque for bracket mounting screw should be 0.5 to 0.7 N·m.



Series ZSE30/ISE30 Specific Product Precautions 2

Be sure to read before handling. Refer to pages 10 through 12 for safety instructions and pressure switch precautions.

Connection/Removal of Connector

- To connect the connector, insert it straight while pinching the lever, and then push the lever into the jack of the housing and lock it.
- To remove the connector, pull it straight out while applying pressure with your thumb to the lever and unhooking it from the jack.

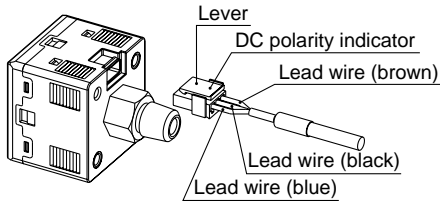

- Do not attempt to insert or pull the pressure sensor or its connector when the power is on. A switch output malfunction may occur.

Piping

- Cut the tube perpendicularly.
- Hold the tube and insert it into the One-touch fitting carefully and securely all the way to the bottom.

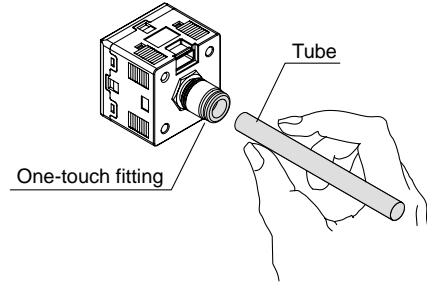

Regulating pressure range and rated pressure range

⚠ Caution

Set the pressure within the rated pressure range.

The regulating pressure range is the range of pressure that is possible in setting.

The rated pressure range is the range of pressure that satisfies the specifications (accuracy, linearity, etc.) on the sensor.

Although it is possible to set a value outside the rated pressure range, the specifications will not be guaranteed even if the value stays within the regulating pressure range.

Switch		Pressure range				
		-100 kPa	0	100 kPa	500 kPa	1 MPa
For vacuum/ low pressure	ZSE30	-100 kPa	100 kPa			
		-101 kPa	101 kPa			
For positive pressure	ISE30		0	1 MPa		
		-100 kPa (-0.1 MPa)		1 MPa		

Rated pressure range of switch
 Regulating pressure range of switch



EUROPEAN SUBSIDIARIES:



Austria

SMC Pneumatik GmbH (Austria).
Girakstrasse 8, A-2100 Korneuburg
Phone: +43 2262-62280, Fax: +43 2262-62285
E-mail: office@smc.at
http://www.smc.at



Belgium

SMC Pneumatics N.V./S.A.
Nijverheidsstraat 20, B-2160 Wommelgem
Phone: 03-355-1464, Fax: 03-355-1466
E-mail: post@smcpneumatics.be



Czech Republic

SMC Industrial Automation CZ s.r.o.
Hudcova 78a, CZ-61200 Brno
Phone: +420 5 414 24611, Fax: +420 5 412 18034
E-mail: office@smc.cz
http://www.smc.cz



Denmark

SMC Pneumatik A/S
Knudsminde 4B, DK-8300 Odder
Phone: (45)70252900, Fax: (45)70252901
E-mail: smc@smc-pneumatik.dk



Estonia

SMC Pneumatics Estonia OÜ
Laki 12-101, 106 21 Tallinn
Phone: 06 593540, Fax: 06 593541
http://www.smcneumatics.ee



Finland

SMC Pneumatics Finland OY
PL72, Tiistiniityntie 4, SF-02031 ESPOO
Phone: 09-859 580, Fax: 09-8595 8595
http://www.smcfitec.sci.fi



France

SMC Pneumatique, S.A.
1, Boulevard de Strasbourg, Parc Gustave Eiffel
Bussy Saint Georges
F-77607 Marne La Vallée Cedex 3
Phone: 01-6476 1000, Fax: 01-6476 1010
http://www.smc-france.fr



Germany

SMC Pneumatik GmbH
Boschring 13-15, D-63329 Egelsbach
Phone: 06103-4020, Fax: 06103-402139
E-mail: info@smc-pneumatik.de
http://www.smc-pneumatik.de



Greece

S. Parianopoulos S.A.
7, Konstantinoupolos Street,
GR-11855 Athens
Phone: 01-3426076, Fax: 01-3455578



Hungary

SMC Hungary Ipari Automatizálási Kft.
Budafoki út 107-113, H-1117 Budapest
Phone: +36 1 371 1343, Fax: +36 1 371 1344
E-mail: office@smc-automation.hu
http://www.smc-automation.hu



Ireland

SMC Pneumatics (Ireland) Ltd.
2002 Citywest Business Campus,
Naas Road, Saggart, Co. Dublin
Phone: 01-403 9000, Fax: 01-464-0500



Italy

SMC Italia S.p.A
Via Garibaldi 62, I-20061 Carugate, (Milano)
Phone: 02-92711, Fax: 02-9271365
E-mail: mailbox@smcitalia.it
http://www.smcitalia.it



Latvia

SMC Pneumatics Latvia SIA
Smerla 1-705, Riga LV-1006, Latvia
Phone: 0777-94-74, Fax: 0777-94-75
http://www.smclv.lv



Lithuania

UAB Ottensten Lietuva
Savanoriu pr. 180, LT-2600 Vilnius, Lithuania
Phone/Fax: 370-2651602



Netherlands

SMC Pneumatics BV
De Ruyterkade 120, NL-1011 AB Amsterdam
Phone: 020-5318888, Fax: 020-5318880
E-mail: info@smcpneumatics.nl



Norway

SMC Pneumatics Norway A/S
Vollsvveien 13 C, Granfos Næringspark
N-1366 Lysaker
Tel: (47) 67 12 90 20, Fax: (47) 67 12 90 21
http://www.smc-norge.no



Poland

SMC Industrial Automation Polska Sp.z.o.o.
ul. Konstruktorska 11A, PL-02-673 Warszawa,
Phone: +48 22 548 5085, Fax: +48 22 548 5087
E-mail: office@smc.pl
http://www.smc.pl



Portugal

SMC Sucursal Portugal, S.A.
Rua de Engº Ferreira Dias 452, 4100-246 Porto
Phone: 22-610-89-22, Fax: 22-610-89-36
E-mail: postpt@smc.smces.es



Romania

SMC Romania srl
Str. Frunzei 29, Sector 2, Bucharest
Phone: 01-324-2626, Fax: 01-324-2627
E-mail: smccadm@canad.ro
http://www.smcromania.ro



Russia

SMC Pneumatik LLC.
36/40 Sredny pr. St. Petersburg 199004
Phone: (812) 118 5445, Fax: (812) 118 5449
E-mail: smcfa@peterlink.ru
http://www.smc-pneumatik.ru



Slovakia

SMC Priemyselná Automatizácia, s.r.o.
Námestie Martina Benku 10
SK-81107 Bratislava
Phone: +421 2 444 56725, Fax: +421 2 444 56028
E-mail: office@smc.sk
http://www.smc.sk



Slovenia

SMC industrijska Avtomatika d.o.o.
Grajski trg 15, SLO-8360 Zuzemberk
Phone: +386 738 85240 Fax: +386 738 85249
E-mail: office@smc-ind-avtom.si
http://www.smc-ind-avtom.si



Spain

SMC España, S.A.
Zuazobidea 14
01015 Vitoria
Phone: 945-184 100, Fax: 945-184 124
E-mail: post@smc.smces.es



Sweden

SMC Pneumatics Sweden AB
Ekhagsvägen 29-31, S-141 71 Huddinge
Phone: 08-603 07 00, Fax: 08-603 07 10
http://www.smc.nu



Switzerland

SMC Pneumatik AG
Dorfstrasse 7, CH-8484 Weisslingen
Phone: 052-396-3131, Fax: 052-396-3191
E-mail: info@smc.ch
http://www.smc.ch



Turkey

Entek Pnömatik San. ve Tic Ltd. Sti.
Perpa Tic. Merkezi Kat: 11 No: 1625,
TR-80270 Okmeydanı Istanbul
Phone: 0212-221-1512, Fax: 0212-221-1519
http://www.entek.com.tr



UK

SMC Pneumatics (UK) Ltd
Vincent Avenue, Crownhill,
Milton Keynes, MK8 0AN
Phone: 0800 1382930 Fax: 01908-555064
E-mail: sales@smcpneumatics.co.uk
http://www.smcneumatics.co.uk



OTHER SUBSIDIARIES WORLDWIDE:

ARGENTINA, AUSTRALIA, BOLIVIA, BRASIL, CANADA, CHILE, CHINA, HONG KONG, INDIA, MALAYSIA, MEXICO, NEW ZEALAND, PHILIPPINES, SINGAPORE, SOUTH KOREA, TAIWAN, THAILAND, USA, VENEZUELA

<http://www.smceu.com>
<http://www.smcworld.com>