Ordering number C12049
Description 1

Family Strada-Forward
 Type Lens
 LED Oslon SSL 150
 Color Clear
 Diameter 15.4 x 19.6 mm
 Height 8.2 mm
 Style Rectang
 Optic Material PMMA
 Holder Material -
 Fastening -
 Status Ready

FWHM Asym degrees
 Efficiency 92 %
 cd/lm -
 Gerber File Available

http://www.ledil.fi/Strada-F_Fully_Asymmetrical_Forward_Thro

Ordering number CA12050
Description 1

Family Strada-Forward
 Type Assembly
 LED Oslon SSL 150
 Color Clear
 Diameter 15.4 x 19.6 mm
 Height 8.35 mm
 Style Rectang
 Optic Material PMMA
 Holder Material -
 Fastening -
 Status Ready

FWHM Asym degrees
 Efficiency 92 %
 cd/lm -
 Gerber File Available

http://www.ledil.fi/Strada-F_Fully_Asymmetrical_Forward_Thro



PRODUCT DATASHEET

Strada-Forward series

last update 31/12/2012



NOTE: The typical divergence will be changed by different color, chip size and chip position tolerance. The typical total divergence is the full angle measured where the luminous intensity is half of the peak value.

D

C

B

A

4

4

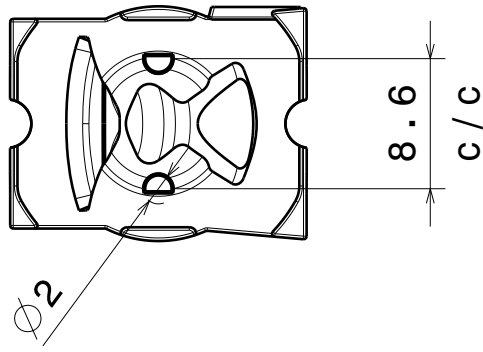

3

3

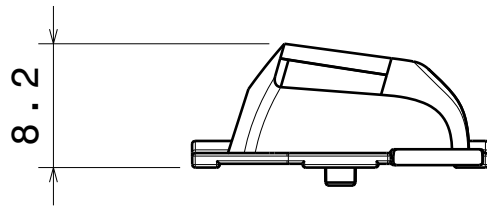

2

2

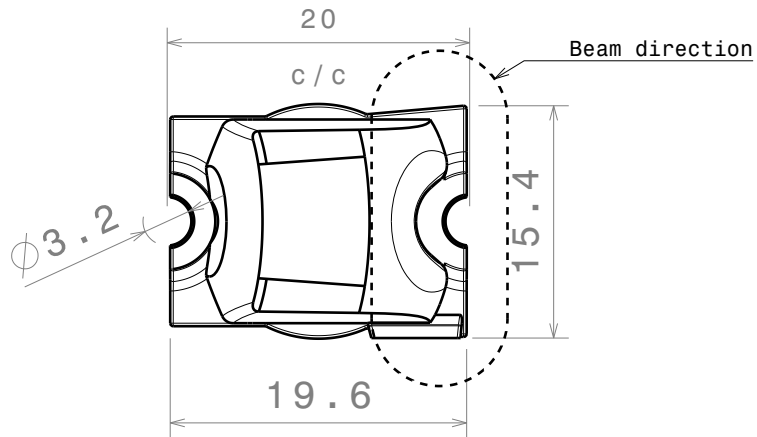

MATERIALS
Lens: PMMA

This drawing is our property.
It can't be reproduced
or communicated without
our written agreement.



Ledil Oy
Salorankatu 10
24240 SALO
Finland

DRAWING TITLE

Datasheet Strada-FT lens

DRAWN BY
ah

DATE
6.7.2012

CHECKED BY
ah

DATE
6.7.2012

SIZE
A4

DRAWING NUMBER

REV
2

DESIGNED BY
hh

DATE
15.3.2011

SCALE 2:1 WEIGHT (g)

SHEET 1/1

D

A

1

1