

ST repetitive voltage suppressor

Datasheet – production data

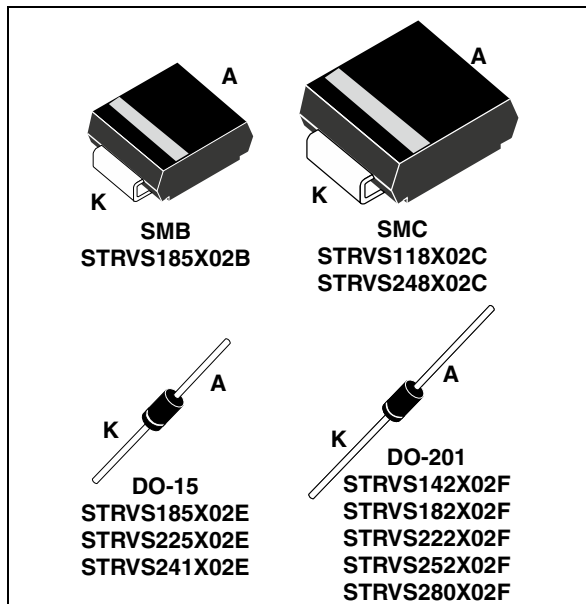

Features

- Clamping voltage characteristics defined at 25 °C, 85 °C and 125 °C
- Stand-off voltage range: from 85 V to 188 V
- Low leakage current: 0.2 μ A at 25 °C
- Maximum operating junction temperatures:
 - SMB and SMC: 150 °C
 - DO-15 and DO-201: 175 °C

Complies with the following standards:

- IEC 61000-4-2 level 4
 - \pm 15 kV (air discharge)
 - \pm 8 kV (contact discharge)
- IEC 61000-4-5 level 4
- MIL-STD-883, method 3015, class 3B:
 - 25 kV HBM (human body model)
- MIL-STD-750, method 2026 solderability
- EIA STD RS-481 and IEC 60286-3 packing (surface mount packages)

Applications

- MOSFET protection
- IGBT protection
- Auxiliary power supply

Description

The STRVSX series is a TVS family created to provide simple and effective solutions for designers working on circuits that require protection from repetitive overvoltages.

The STRVSX series is highly reliable and suits applications where the surge frequency makes the protected device temperature increase, for example, MOSFET protection in fly back configuration.

Additional support for designers using these devices is available in the STMicroelectronics application note AN4209: "Design methodology for repetitive voltage suppressors (RVS) in repetitive mode: STRVS".

Table 1. Device summary

| CPN | Clamping voltage $I_{PP} = 2 \text{ A (125 } ^\circ)$ | Package |
|--------------|--|---------|
| STRVS118X02C | 118 V | SMC |
| STRVS142X02F | 142 V | DO-201 |
| STRVS182X02F | 182 V | DO-201 |
| STRVS185X02B | 185 V | SMB |
| STRVS182X02E | 185 V | DO-15 |
| STRVS222X02F | 222 V | DO-201 |
| STRVS225X02E | 225 V | DO-15 |
| STRVS241X02E | 241 V | DO-15 |
| STRVS248X02C | 248 V | SMC |
| STRVS252X02F | 252 V | DO-201 |
| STRVS280X02F | 280 V | DO-201 |

1 Characteristics

Table 2. Absolute maximum ratings ($T_{amb} = 25\text{ °C}$)

| Symbol | Parameter | Value | Unit |
|-----------|---|------------|------|
| T_j | Operating junction temperature range (SMB and SMC) | -55 to 150 | °C |
| | Operating junction temperature range (DO-15 and DO-201) | -55 to 175 | °C |
| T_{stg} | Storage temperature range (SMB and SMC) | -65 to 150 | °C |
| | Storage temperature range (DO-15 and DO-201) | -65 to 175 | °C |
| T_L | Maximum lead temperature for soldering during 10 s (SMB and SMC) | 260 | °C |
| | Maximum lead temperature for soldering during 10 s at 5 mm from case (DO-15 and DO-201) | 260 | °C |

Table 3. Thermal resistances

| Symbol | Parameter | Value | Unit | |
|---------------|------------------------------------|--------|------|------|
| $R_{th(j-l)}$ | Junction to leads | SMB | 13 | °C/W |
| | | SMC | 12 | |
| | | DO-15 | 35 | |
| | | DO-201 | 23 | |
| $R_{th(j-a)}$ | Junction to ambient ⁽¹⁾ | SMB | 185 | |
| | | SMC | 150 | |
| | | DO-15 | 105 | |
| | | DO-201 | 100 | |

1. On printed circuit with recommended pad layout

Figure 1. Electrical characteristics - definitions

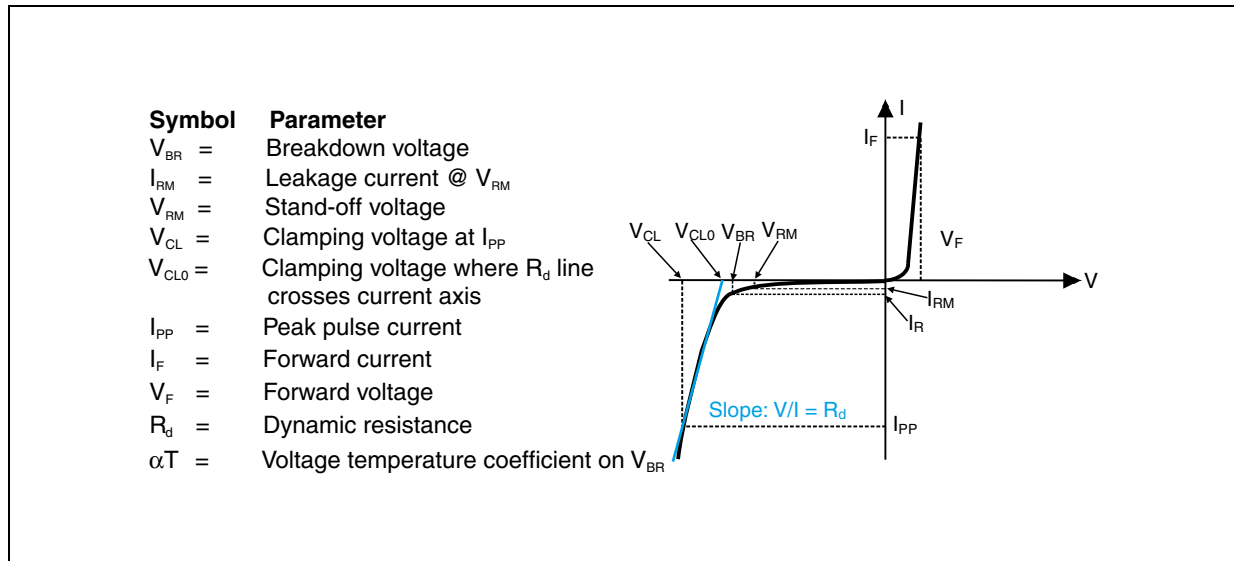

Table 4. Electrical characteristics - values

| Order code | $I_{RM} \text{ max @ } V_{RM}$ (25 °C) | | $V_{BR} \text{ @ } I_R^{(1)} \text{ (25 °C)}$ | | Values @ 125 °C (typ.) | | | | αT | |
|----------------|---|-----|---|------|------------------------|----------------------------|-----------|-------------|------------|---------------------|
| | | | Min. | Max. | I_{PP} | $V_{CL} \text{ @ } I_{pp}$ | V_{CL0} | $R_d^{(2)}$ | Max. | |
| | μA | V | V | | mA | A | V | V | Ω | $10^{-4}/^{\circ}C$ |
| STRVS118X02C | 0.2 | 85 | 95 | 105 | 1 | 2 | 118 | 116 | 1.0 | 10.6 |
| STRVS142X02F | 1 | 102 | 114 | 126 | 1 | 2 | 142 | 140 | 1.0 | 10.7 |
| STRVS182X02F | 1 | 128 | 143 | 158 | 1 | 2 | 182 | 177 | 2.5 | 10.8 |
| STRVS185X02B/E | 0.2 | 128 | 143 | 158 | 1 | 2 | 185 | 178 | 2.5 | 10.8 |
| STRVS222X02F | 1 | 154 | 171 | 189 | 1 | 2 | 222 | 213 | 4.5 | 10.8 |
| STRVS225X02E | 0.5 | 154 | 171 | 189 | 1 | 2 | 225 | 214 | 5.5 | 10.8 |
| STRVS241X02E | 0.5 | 171 | 190 | 210 | 1 | 2 | 241 | 234 | 3.5 | 10.8 |
| STRVS248X02C | 0.5 | 171 | 190 | 210 | 1 | 2 | 248 | 238 | 5.0 | 10.8 |
| STRVS252X02F | 1 | 171 | 190 | 210 | 1 | 2 | 252 | 239 | 6.5 | 10.8 |
| STRVS280X02F | 1 | 188 | 209 | 231 | 1 | 2 | 280 | 263 | 8.5 | 10.8 |

1. To calculate V_{BR} at a given junction temperature, use the following formula: $V_{BR} \text{ @ } T_j = V_{BR} \text{ @ } 25 \text{ °C} \times (1 + \alpha T \times (T_j - 25))$

2. $R_d = (V_{CL} - V_{CL0})/I_{PP}$

Figure 2. Clamping voltage versus peak pulse current - STRVS118X02C (typical values)

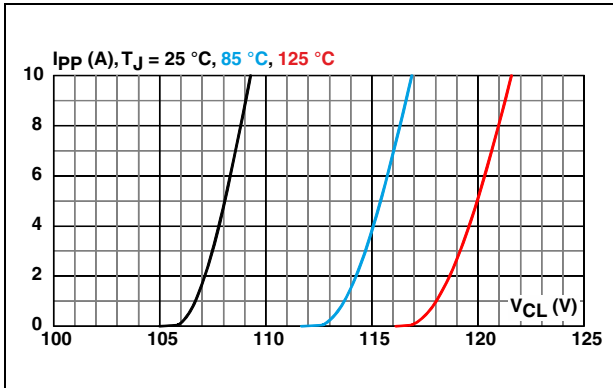

Figure 3. Clamping voltage versus peak pulse current - STRVS142X02F (typical values)

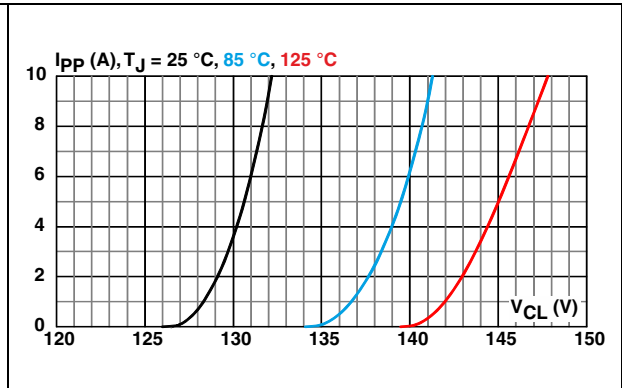

Figure 4. Clamping voltage versus peak pulse current - STRVS182X02F (typical values)

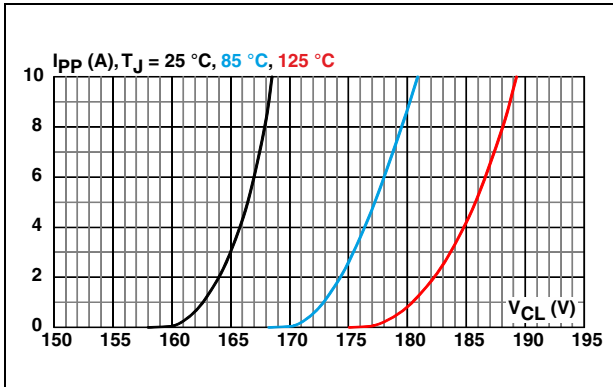

Figure 5. Clamping voltage versus peak pulse current - STRVS185X02B/E (typical values)

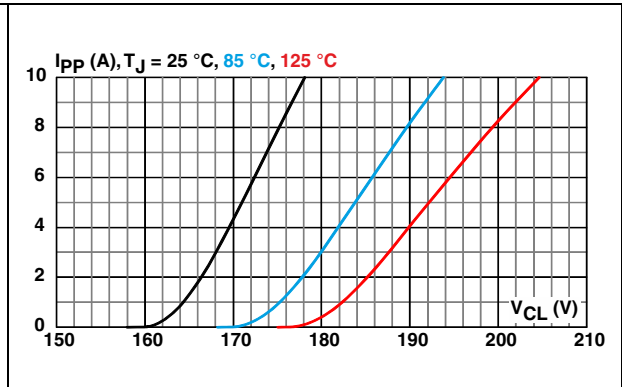

Figure 6. Clamping voltage versus peak pulse current - STRVS222X02F (typical values)

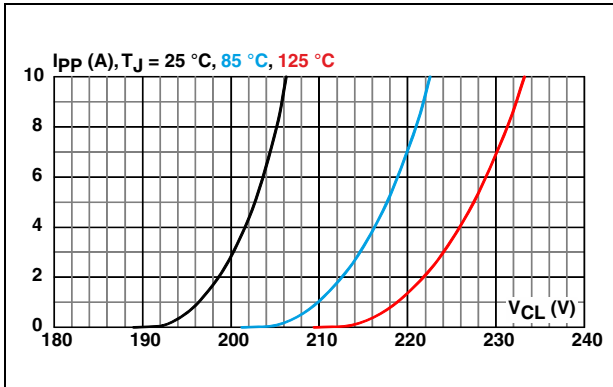

Figure 7. Clamping voltage versus peak pulse current - STRVS225X02E (typical values)

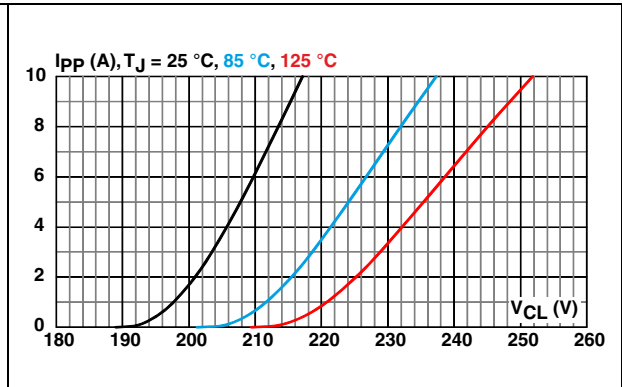

Figure 8. Clamping voltage versus peak pulse current - STRVS241X02E (typical values)

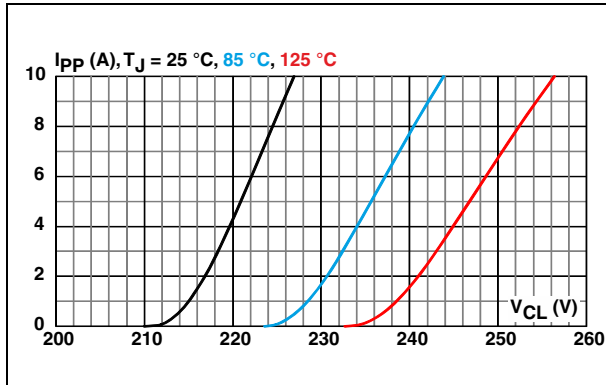

Figure 9. Clamping voltage versus peak pulse current - STRVS248X02C (typical values)

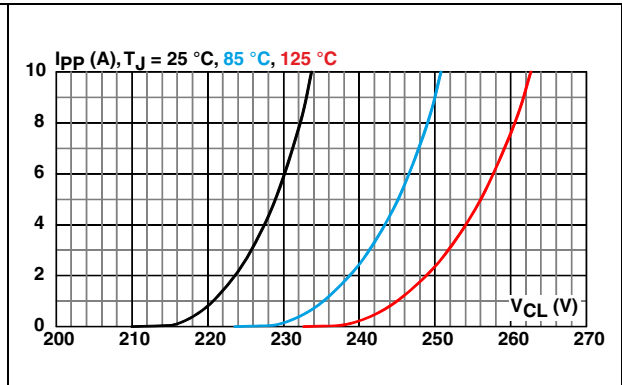

Figure 10. Clamping voltage versus peak pulse current - STRVS252X02F

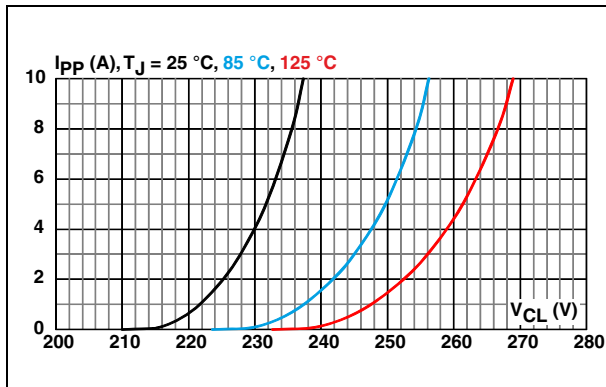

Figure 11. Clamping voltage versus peak pulse current - STRVS280X02F

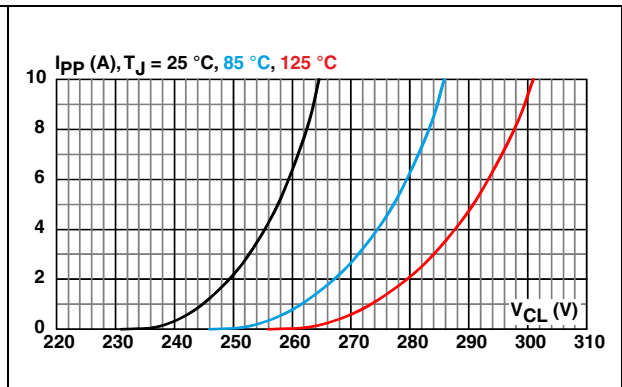

Figure 12. Leakage current versus junction temperature (typical values) STRVSxxxC

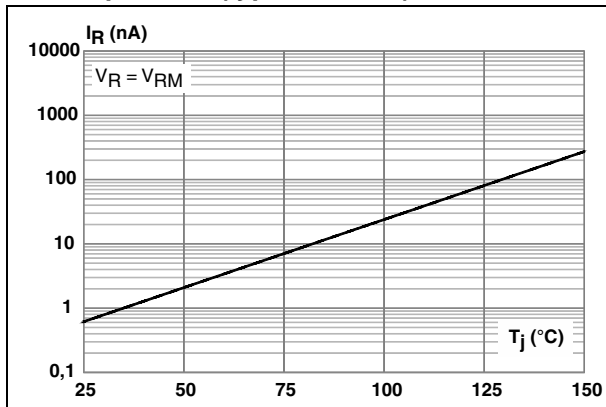

Figure 13. Leakage current versus junction temperature (typical values) STRVSxxxF

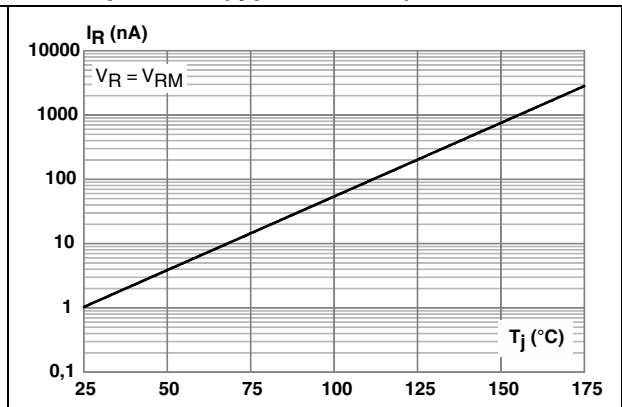

Figure 14. Leakage current versus junction temperature (typical values) STRVSxxxB

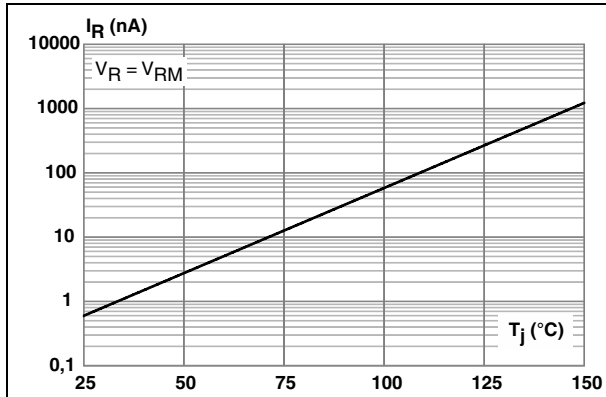

Figure 15. Leakage current versus junction temperature (typical values) STRVSxxxE

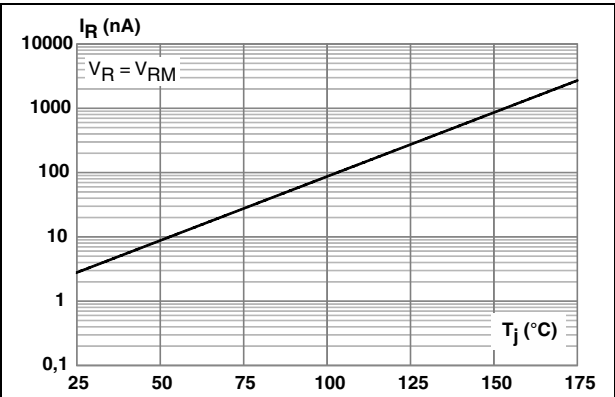

Figure 16. Thermal resistance junction to ambient versus copper surface of connections - SMB

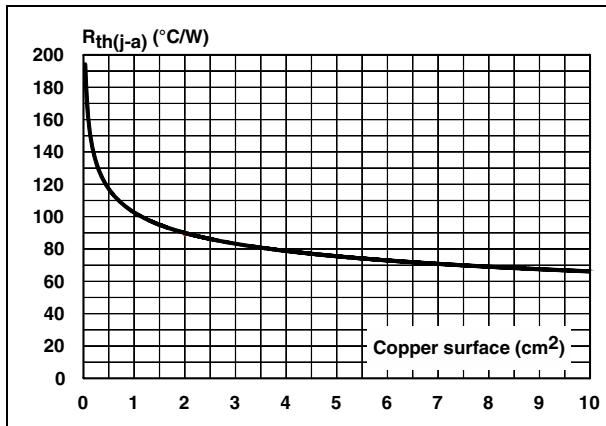

Figure 17. Thermal resistance junction to ambient versus copper surface of connections - SMC

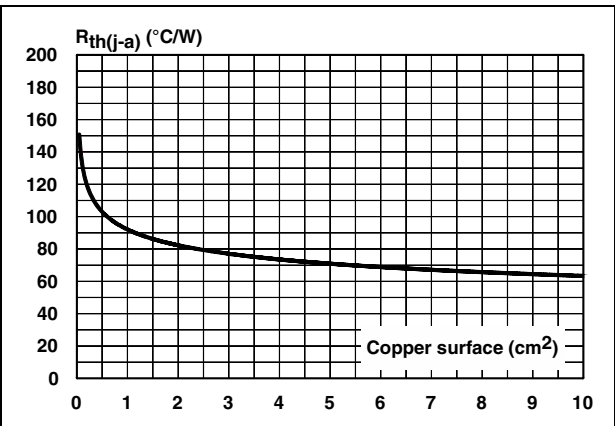

Figure 18. Thermal resistance junction to ambient versus copper surface of connections - DO-15

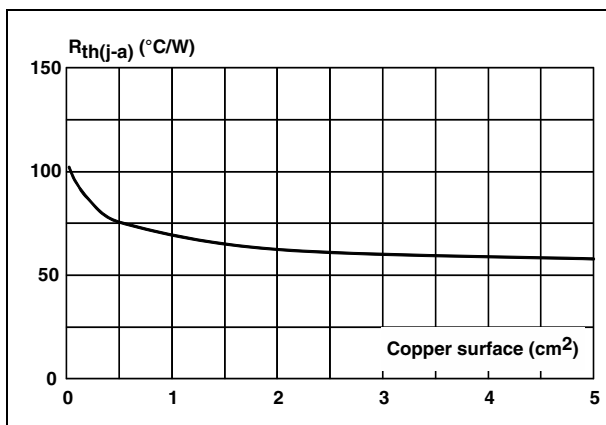
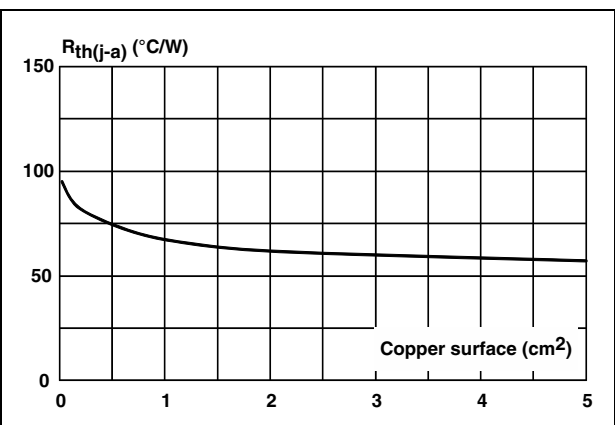

Figure 19. Thermal resistance junction to ambient versus copper surface of connections - DO-201



2 Package information

- Epoxy meets UL94, V0
- Lead-free package
- Polarity: band indicates cathode
- Terminals: solder plated, solderable as per MIL-STD-750, method 2026

In order to meet environmental requirements, ST offers these devices in different grades of ECOPACK[®] packages, depending on their level of environmental compliance. ECOPACK[®] specifications, grade definitions and product status are available at: www.st.com. ECOPACK[®] is an ST trademark.

Figure 20. SMB dimension definitions

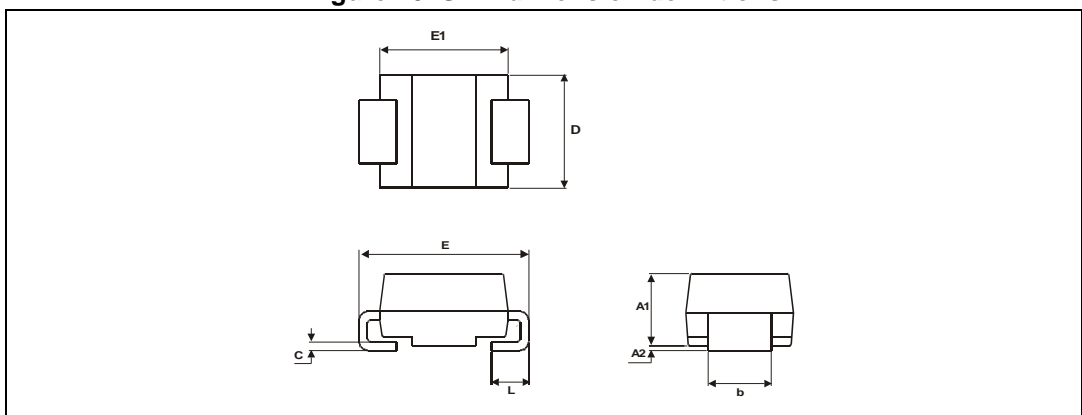

Table 5. SMB dimension values

| Ref. | Dimensions | | | |
|------|-------------|------|--------|-------|
| | Millimeters | | Inches | |
| | Min. | Max. | Min. | Max. |
| A1 | 1.90 | 2.45 | 0.075 | 0.096 |
| A2 | 0.05 | 0.20 | 0.002 | 0.008 |
| b | 1.95 | 2.20 | 0.077 | 0.087 |
| c | 0.15 | 0.40 | 0.006 | 0.016 |
| D | 3.30 | 3.95 | 0.130 | 0.156 |
| E | 5.10 | 5.60 | 0.201 | 0.220 |
| E1 | 4.05 | 4.60 | 0.159 | 0.181 |
| L | 0.75 | 1.50 | 0.030 | 0.059 |

Figure 21. SMB Footprint, dimensions in mm (inches)

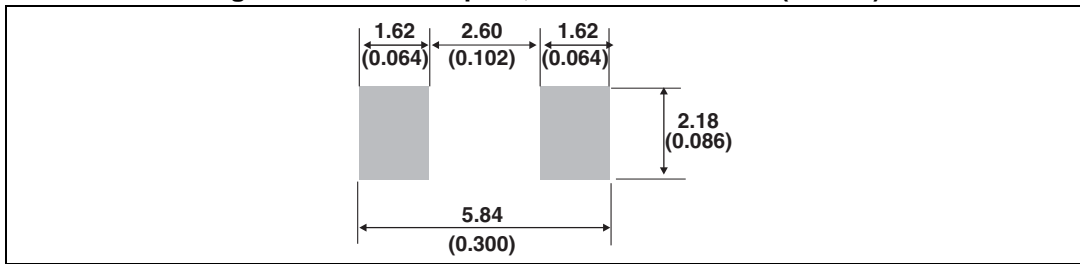

Figure 22. SMB marking layout

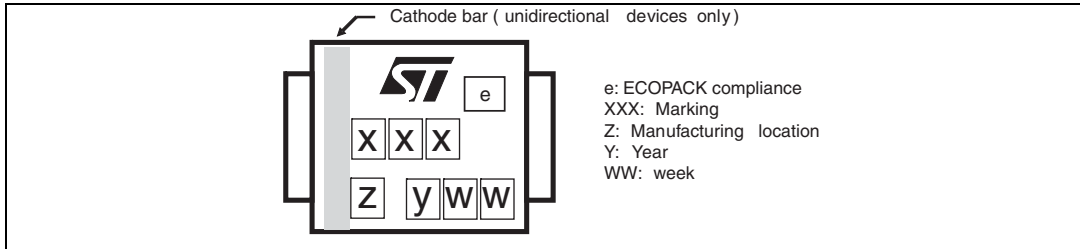

Figure 23. SMC dimension definitions

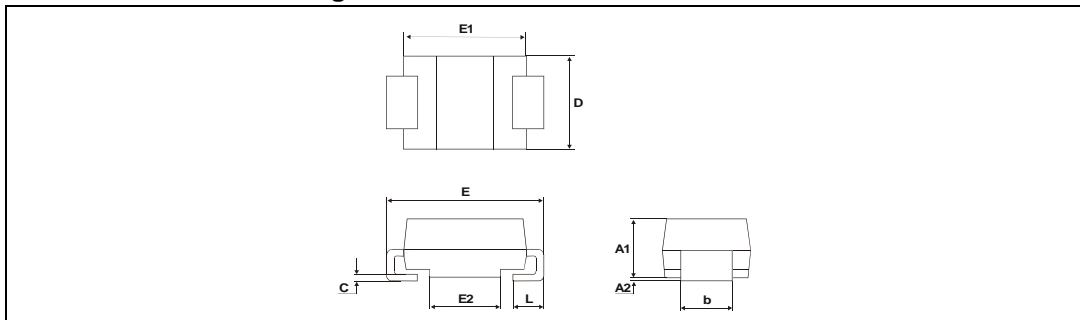

Table 6. SMC dimension values

| Ref. | Dimensions | | | |
|------------------|-------------|------|--------|-------|
| | Millimeters | | Inches | |
| | Min. | Max. | Min. | Max. |
| A1 | 1.90 | 2.45 | 0.075 | 0.096 |
| A2 | 0.05 | 0.20 | 0.002 | 0.008 |
| b ⁽¹⁾ | 2.90 | 3.20 | 0.114 | 0.126 |
| c ⁽¹⁾ | 0.15 | 0.40 | 0.006 | 0.016 |
| D | 5.55 | 6.25 | 0.218 | 0.246 |
| E | 7.75 | 8.15 | 0.305 | 0.321 |
| E1 | 6.60 | 7.15 | 0.260 | 0.281 |
| E2 | 4.40 | 4.70 | 0.173 | 0.185 |
| L | 0.75 | 1.50 | 0.030 | 0.059 |

1. Dimensions b and c apply to plated leads

Figure 24. SMC footprint, dimensions in mm (inches)

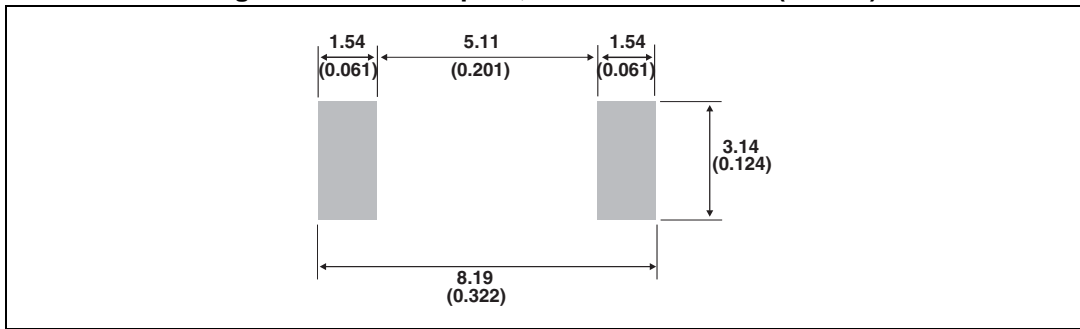

Figure 25. SMC marking layout

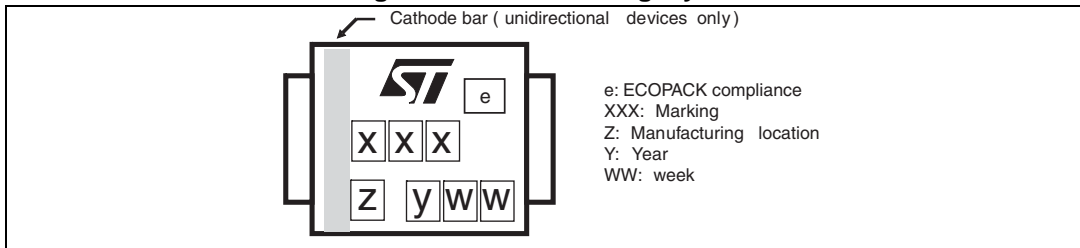

Figure 26. DO-15 dimension definitions

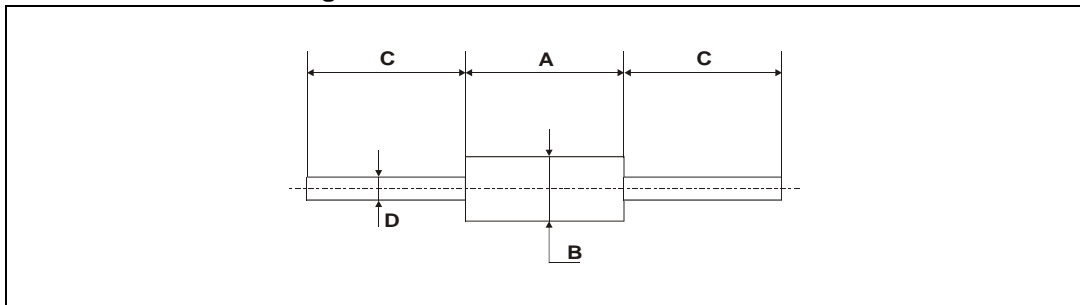

Table 7. DO-15 dimension values

| Ref. | Dimensions | | | |
|------|-------------|------|--------|-------|
| | Millimeters | | Inches | |
| | Min. | Max. | Min. | Max. |
| A | 6.05 | 6.75 | 0.238 | 0.266 |
| B | 2.95 | 3.53 | 0.116 | 0.139 |
| C | 26 | 31 | 1.024 | 1.220 |
| D | 0.71 | 0.88 | 0.028 | 0.035 |

Figure 27. DO-201 dimension definitions

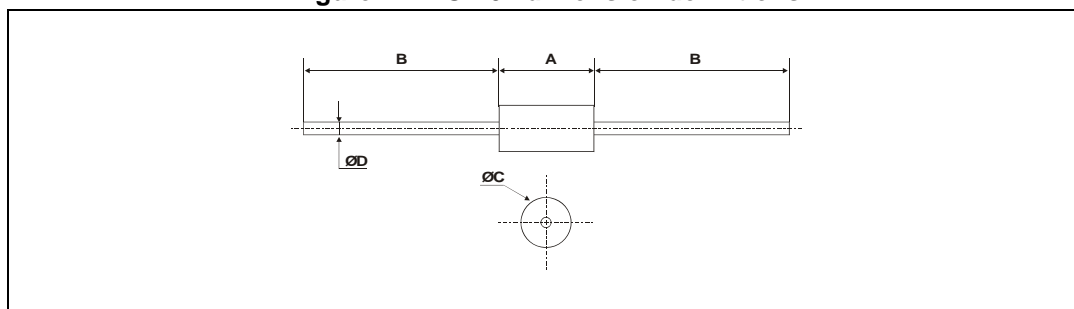

Table 8. DO-201 dimension values

| Ref. | Dimensions | | | |
|------|-------------|------|--------|-------|
| | Millimeters | | Inches | |
| | Min. | Max. | Min. | Max. |
| A | 8.5 | 9.5 | 0.335 | 0.374 |
| B | 25.4 | | 1 | |
| Ø C | 4.8 | 5.3 | 0.189 | 0.209 |
| Ø D | 0.96 | 1.06 | 0.038 | 0.042 |

3 Ordering information

Figure 28. Ordering information scheme

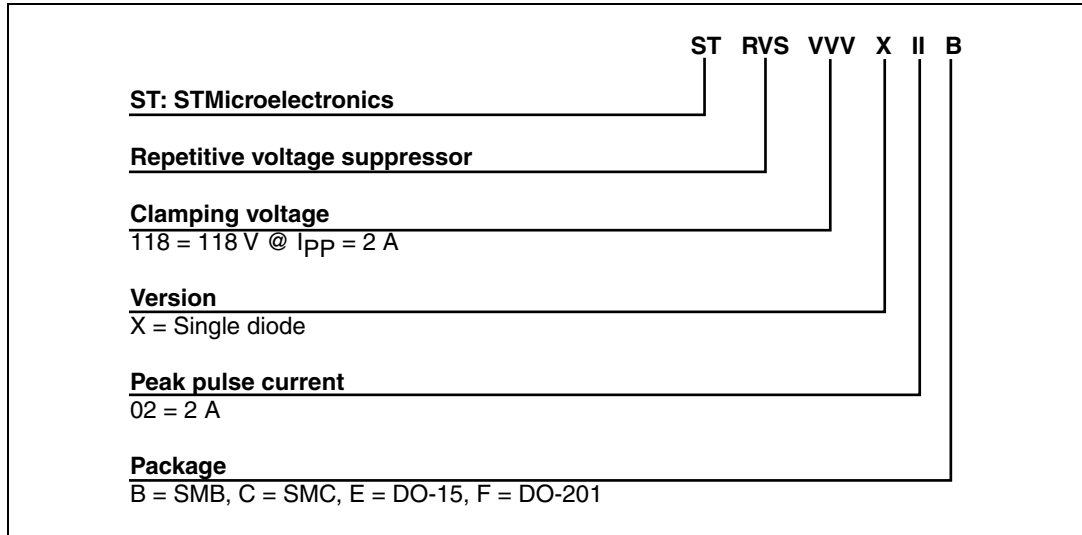

Table 9. Ordering information

| Order code | Marking | Package | Weight | Base qty. | Delivery mode |
|--------------|---------|---------|--------|-----------|---------------|
| STRVS118X02C | R118C | SMC | 0.25 g | 2500 | Tape and reel |
| STRVS142X02F | R142F | DO-201 | 0.90 g | 600 | Ammopack |
| STRVS182X02F | R182F | DO-201 | 0.90 g | 600 | Ammopack |
| STRVS185X02B | R185B | SMB | 0.12 | 2500 | Tape and reel |
| STRVS185X02E | R185E | DO-15 | 0.40 | 1000 | Ammopack |
| STRVS222X02F | R222F | DO-201 | 0.90 g | 600 | Ammopack |
| STRVS225X02E | R225E | DO-15 | 0.40 | 1000 | Ammopack |
| STRVS241X02E | R241E | DO-15 | 0.40 | 1000 | Ammopack |
| STRVS248X02C | R4248C | SMC | 0.25 g | 2500 | Tape and reel |
| STRVS252X02F | R252F | DO-201 | 0.90 g | 600 | Ammopack |
| STRVS280X02F | R280F | DO-201 | 0.90 g | 600 | Ammopack |

4 Revision history

Table 10. Document revision history

| Date | Revision | Changes |
|-------------|----------|--|
| 05-Mar-2013 | 1 | Initial release. |
| 18-Apr-2013 | 2 | Insertion of Table 1 . |

Please Read Carefully:

Information in this document is provided solely in connection with ST products. STMicroelectronics NV and its subsidiaries ("ST") reserve the right to make changes, corrections, modifications or improvements, to this document, and the products and services described herein at any time, without notice.

All ST products are sold pursuant to ST's terms and conditions of sale.

Purchasers are solely responsible for the choice, selection and use of the ST products and services described herein, and ST assumes no liability whatsoever relating to the choice, selection or use of the ST products and services described herein.

No license, express or implied, by estoppel or otherwise, to any intellectual property rights is granted under this document. If any part of this document refers to any third party products or services it shall not be deemed a license grant by ST for the use of such third party products or services, or any intellectual property contained therein or considered as a warranty covering the use in any manner whatsoever of such third party products or services or any intellectual property contained therein.

UNLESS OTHERWISE SET FORTH IN ST'S TERMS AND CONDITIONS OF SALE ST DISCLAIMS ANY EXPRESS OR IMPLIED WARRANTY WITH RESPECT TO THE USE AND/OR SALE OF ST PRODUCTS INCLUDING WITHOUT LIMITATION IMPLIED WARRANTIES OF MERCHANTABILITY, FITNESS FOR A PARTICULAR PURPOSE (AND THEIR EQUIVALENTS UNDER THE LAWS OF ANY JURISDICTION), OR INFRINGEMENT OF ANY PATENT, COPYRIGHT OR OTHER INTELLECTUAL PROPERTY RIGHT.

ST PRODUCTS ARE NOT AUTHORIZED FOR USE IN WEAPONS. NOR ARE ST PRODUCTS DESIGNED OR AUTHORIZED FOR USE IN: (A) SAFETY CRITICAL APPLICATIONS SUCH AS LIFE SUPPORTING, ACTIVE IMPLANTED DEVICES OR SYSTEMS WITH PRODUCT FUNCTIONAL SAFETY REQUIREMENTS; (B) AERONAUTIC APPLICATIONS; (C) AUTOMOTIVE APPLICATIONS OR ENVIRONMENTS, AND/OR (D) AEROSPACE APPLICATIONS OR ENVIRONMENTS. WHERE ST PRODUCTS ARE NOT DESIGNED FOR SUCH USE, THE PURCHASER SHALL USE PRODUCTS AT PURCHASER'S SOLE RISK, EVEN IF ST HAS BEEN INFORMED IN WRITING OF SUCH USAGE, UNLESS A PRODUCT IS EXPRESSLY DESIGNATED BY ST AS BEING INTENDED FOR "AUTOMOTIVE, AUTOMOTIVE SAFETY OR MEDICAL" INDUSTRY DOMAINS ACCORDING TO ST PRODUCT DESIGN SPECIFICATIONS. PRODUCTS FORMALLY ESCC, QML OR JAN QUALIFIED ARE DEEMED SUITABLE FOR USE IN AEROSPACE BY THE CORRESPONDING GOVERNMENTAL AGENCY.

Resale of ST products with provisions different from the statements and/or technical features set forth in this document shall immediately void any warranty granted by ST for the ST product or service described herein and shall not create or extend in any manner whatsoever, any liability of ST.

ST and the ST logo are trademarks or registered trademarks of ST in various countries.

Information in this document supersedes and replaces all information previously supplied.

The ST logo is a registered trademark of STMicroelectronics. All other names are the property of their respective owners.

© 2013 STMicroelectronics - All rights reserved

STMicroelectronics group of companies

Australia - Belgium - Brazil - Canada - China - Czech Republic - Finland - France - Germany - Hong Kong - India - Israel - Italy - Japan - Malaysia - Malta - Morocco - Philippines - Singapore - Spain - Sweden - Switzerland - United Kingdom - United States of America

www.st.com

