

3641ITP125P63 Flat

EAN 4031582337440

Swivel castor with directional lock, housing made of heavy pressed steel, bright zinc plated, blue passivated, precision ball bearing swivel head, sealed, wheel axle with nut, plate fitting.

Wheel centre made of Aluminium, Tread: Polyurethane, casted, precision ball bearing
Hint:

This castor can be fitted with a directional lock. However, the lock does not come as standard and has to be ordered as an optional extra.



Technical Data

Wheel diameter	125 mm
Width of Tread	50 mm
Size of Plate	137 x 105 mm
Plate hole centres	105 x 80/75 mm
Plate hole	11 mm
Offset	55 mm
Swivel Interference	310 mm
Overall height	178 mm
Temperature	- 20 / + 60 °C
Standard	EN 12532
Weight	2.901 kg
Hardness of tread	A 92 Shore
Load capacity	500 kg
Load capacity (static)	1000 kg

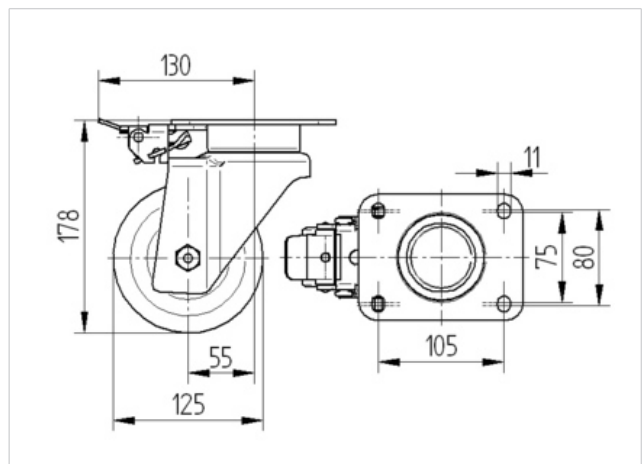

Roll performance	+	+	+	+	+
Movement noise	+	+	+	+	+
Attrition	+	+	+	+	+
Corrosion resistance	+	+	+	+	+



3641ITP125P63 Flat

EAN 4031582337440

