

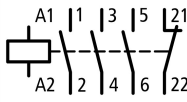

Contactor, 3p+1N/C, 5.5kW/400V/AC3

Part no. DILM12-01(230V50HZ,240V60HZ)
Article no. 276865
Catalog No. XTCE012B01F

Delivery programme

| | | | | |
|---|----------------|----|--|--|
| Product range | | | | Contactors |
| Application | | | | Contactors for Motors |
| Subrange | | | | Contactors up to 170 A, 3 pole |
| Utilization category | | | | AC-1: Nicht induktive oder schwach induktive Last, Widerstandsöfen AC-3: Käfigläufermotoren: Anlassen, Ausschalten während des Laufes AC-4: Käfigläufermotoren: Anlassen, Gegenstrombremsen, Reversieren, Tippen |
| Notes | | | |  Also suitable for motors with efficiency class IE3. IE3-ready devices are identified by the logo on their packaging. |
| Connection technique | | | | Screw terminals |
| Pole | | | | 3 pole |
| Rated operational current | | | | |
| AC-3 | | | | |
| 380 V 400 V | I_e | A | | 12 |
| AC-1 | | | | |
| Conventional free air thermal current, 3 pole, 50 - 60 Hz | | | | |
| Open | | | | |
| at 40 °C | $I_{th} = I_e$ | A | | 22 |
| enclosed | I_{th} | A | | 18 |
| Conventional free air thermal current, 1 pole | | | | |
| open | I_{th} | A | | 50 |
| enclosed | I_{th} | A | | 45 |
| Max. rating for three-phase motors, 50 - 60 Hz | | | | |
| AC-3 | | | | |
| 220 V 230 V | P | kW | | 3.5 |
| 380 V 400 V | P | kW | | 5.5 |
| 660 V 690 V | P | kW | | 6.5 |
| AC-4 | | | | |
| 220 V 230 V | P | kW | | 2 |
| 380 V 400 V | P | kW | | 3 |
| 660 V 690 V | P | kW | | 4.4 |
| Contacts | | | | |
| N/C = Normally closed | | | | 1 NC |
| Contact sequence | | | |  |
| Instructions | | | | |
| Can be combined with auxiliary contact | | | | DILA-XHI(V).. |
| Voltage AC/DC | | | | AC operation |

Technical data

| | | | | |
|----------------------|--|--|--|---------------------------------|
| General | | | | |
| Standards | | | | IEC/EN 60947, VDE 0660, UL, CSA |
| Lifespan, mechanical | | | | |

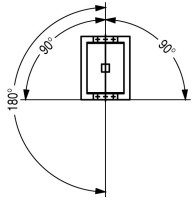
| | | | |
|--|--------------|-------------------|--|
| AC operated | Operations | x 10 ⁶ | 10 |
| DC operated | Operations | x 10 ⁶ | 10 |
| Operating frequency, mechanical | | | |
| AC operated | Operations/h | | 5000 |
| DC operated | Operations/h | | 5000 |
| Climatic proofing | | | |
| Damp heat, constant, to IEC 60068-2-78 Damp heat, cyclic, to IEC 60068-2-30 | | | |
| Ambient temperature | | °C | |
| Open | | °C | - 25 - 60 |
| Enclosed | | °C | - 25 - 40 |
| Storage | | °C | - 40 - 80 |
| Mounting position | | |  |
| Mechanical shock resistance (IEC/EN 60068-2-27) | | | |
| Half-sinusoidal shock, 10 ms | | | |
| Main contacts | | | |
| N/O contact | | g | 10 |
| Auxiliary contacts | | | |
| N/O contact | | g | 7 |
| N/C contact | | g | 5 |
| Mechanical shock resistance (IEC/EN 60068-2-27) when tabletop-mounted | | | |
| Half-sinusoidal shock, 10 ms | | | |
| Main contacts | | | |
| N/O contact | | g | 5.7 |
| Auxiliary contacts | | | |
| N/O contact | | g | 3.4 |
| N/C contact | | g | 3.4 |
| Degree of Protection | | | |
| Protection against direct contact when actuated from front (EN 50274) | | | Finger and back-of-hand proof |
| Weight | | | |
| AC operated | | kg | 0.23 |
| DC operated | | kg | 0.28 |
| Terminal capacity main cable | | | |
| Solid | | mm ² | 1 x (0.75 - 4) 2 x (0.75 - 2.5) |
| Flexible with ferrule | | mm ² | 1 x (0.75 - 2.5) 2 x (0.75 - 2.5) |
| Also without ferrule. | | | |
| Solid or stranded | | AWG | 18 - 10 |
| Main cable connection screw/bolt | | | |
| | | | M3.5 |
| Tightening torque | | | |
| | | | Nm 1.2 |
| Terminal capacity control circuit cables | | | |
| Solid | | mm ² | 1 x (0.75 - 4) 2 x (0.75 - 2.5) |
| Flexible with ferrule | | mm ² | 1 x (0.75 - 2.5) 2 x (0.75 - 2.5) |
| Solid or stranded | | AWG | 18 - 14 |
| Control circuit cable connection screw/bolt | | | |
| | | | M3.5 |
| Tightening torque | | | |
| | | | Nm 1.2 |
| Tool | | | |
| Main cable | | | |
| Pozidriv screwdriver | | Size | 2 |
| Standard screwdriver | | mm | 0.8 x 5.5 1 x 6 |

| | | | |
|--|--|-----------------|--------------------------------------|
| Control circuit cables | | | |
| Pozidriv screwdriver | | Size | 2 |
| Standard screwdriver | | mm | 0.8 x 5.5 1 x 6 |
| Terminal capacity main cable | | | |
| Solid | | mm ² | 1 x (0.75 - 2.5) 2 x (0.75 - 2.5) |
| flexible | | mm ² | 1 x (0.75 - 2.5) 2 x (0.75 - 2.5) |
| flexible with ferrules | | mm ² | 1 x (0.75 - 1.5) 2 x (0.75 - 1.5) |
| Solid or stranded | | AWG | 18 - 14 |
| Terminal capacity control circuit cables | | | |
| Solid | | mm ² | 1 x (0.75 - 2.5) 2 x (0.75 - 2.5) |
| Flexible | | mm ² | 1 x (0.75 - 2.5) 2 x (0.75 - 2.5) |
| Flexible with ferrule | | mm ² | 1 x (0.75 - 1.5) 2 x (0.75 - 1.5) |
| Solid or stranded | | AWG | 18 - 14 |
| Tool | | | |
| Stripping length | | mm | 10 |
| Screwdriver blade width | | mm | 3.5 |

Main conducting paths

| | | | |
|--|----------------|------|-------|
| Rated impulse withstand voltage | U_{imp} | V AC | 8000 |
| Overvoltage category/pollution degree | | | III/3 |
| Rated insulation voltage | U_i | V AC | 690 |
| Rated operational voltage | U_e | V AC | 690 |
| Safe isolation to EN 61140 | | | |
| between coil and contacts | | V AC | 400 |
| between the contacts | | V AC | 400 |
| Making capacity (p.f. to IEC/EN 60947) | | | |
| | U_p to 690 V | A | 144 |
| Breaking capacity | | | |
| 220 V 230 V | | A | 120 |
| 380 V 400 V | | A | 120 |
| 500 V | | A | 100 |
| 660 V 690 V | | A | 70 |
| Short-circuit rating | | | |
| Short-circuit protection maximum fuse | | | |
| Type "2" coordination | | | |
| 400 V | gG/gL 500 V | A | 20 |
| 690 V | gG/gL 690 V | A | 20 |
| Type "1" coordination | | | |
| 400 V | gG/gL 500 V | A | 35 |
| 690 V | gG/gL 690 V | A | 25 |

AC

| | | | |
|---|----------------|---|----|
| AC-1 | | | |
| Rated operational current | | | |
| Conventional free air thermal current, 3 pole, 50 - 60 Hz | | | |
| Open | | | |
| at 40 °C | $I_{th} = I_e$ | A | 22 |
| at 50 °C | $I_{th} = I_e$ | A | 21 |
| at 55 °C | $I_{th} = I_e$ | A | 21 |
| at 60 °C | $I_{th} = I_e$ | A | 20 |
| enclosed | I_{th} | A | 18 |
| Conventional free air thermal current, 1 pole | | | |
| open | I_{th} | A | 50 |

| | | | |
|---------------------------|----------|-----|-----|
| enclosed | I_{th} | A | 45 |
| AC-3 | | | |
| Rated operational current | | | |
| Open, 3-pole: 50 – 60 Hz | | | |
| 220 V 230 V | I_e | A | 12 |
| 240 V | I_e | A | 12 |
| 380 V 400 V | I_e | A | 12 |
| 415 V | I_e | A | 12 |
| 440V | I_e | A | 12 |
| 500 V | I_e | A | 10 |
| 660 V 690 V | I_e | A | 7 |
| 380 V 400 V | I_e | A | 12 |
| Motor rating | | | |
| 220 V 230 V | P | kWh | |
| 240V | P | kW | 3.5 |
| 380 V 400 V | P | kW | 4 |
| 415 V | P | kW | 5.5 |
| 440 V | P | kW | 7 |
| 500 V | P | kW | 7.5 |
| 660 V 690 V | P | kW | 7 |
| 660 V 690 V | P | kW | 6.5 |
| AC-4 | | | |
| Open, 3-pole: 50 – 60 Hz | | | |
| 220 V 230 V | I_e | A | 7 |
| 240 V | I_e | A | 7 |
| 380 V 400 V | I_e | A | 7 |
| 415 V | I_e | A | 7 |
| 440 V | I_e | A | 7 |
| 500 V | I_e | A | 6 |
| 660 V 690 V | I_e | A | 5 |
| Motor rating | | | |
| 220 V 230 V | P | kWh | |
| 240 V | P | kW | 2 |
| 380 V 400 V | P | kW | 2.2 |
| 415 V | P | kW | 3 |
| 440 V | P | kW | 3.4 |
| 500 V | P | kW | 3.6 |
| 660 V 690 V | P | kW | 3.5 |
| 660 V 690 V | P | kW | 4.4 |

DC

| | | | |
|---------------------------------|-------|---|-----|
| Rated operational current, open | | | |
| DC-1 | | | |
| 60 V | I_e | A | 20 |
| 110 V | I_e | A | 20 |
| 220 V | I_e | A | 15 |
| 440 V | I_e | A | 1.3 |
| DC-3 | | | |
| 60 V | I_e | A | 20 |
| 110 V | I_e | A | 20 |
| 220 V | I_e | A | 1.5 |
| 440 V | I_e | A | 0.2 |
| DC-5 | | | |
| 60 V | I_e | A | 20 |
| 110 V | I_e | A | 20 |
| 220 V | I_e | A | 1.5 |

| | | | |
|--|----------|---------------|---|
| 440 V | I_e | A | 0.2 |
| Current heat loss | | | |
| 3-pole at I_{th} | | W | 3 |
| Current heat loss at I_e to AC-3/400 V | | W | 1.1 |
| Impedance per pole | | m Ω | 2.5 |
| Magnet systems | | | |
| Voltage tolerance | | $\times U_c$ | |
| AC operated | Pick-up | $\times U_c$ | 0.8 - 1.1 |
| Drop-out voltage AC operated | Drop-out | $\times U_c$ | 0.3 - 0.6 |
| DC operated | Pick-up | $\times U_c$ | 0.7 - 1.2 |
| DC operated | Drop-out | $\times U_c$ | 0.15 - 0.6 |
| Notes | | | at least smoothed two-phase bridge rectifier or three-phase rectifier |
| Power consumption of the coil in a cold state and $1.0 \times U_c$ | | | |
| 50 Hz | Pick-up | VA | 24 |
| 50 Hz | Sealing | VA | 3.4 |
| 50 Hz | Sealing | W | 1.2 |
| 60 Hz | Pick-up | VA | 30 |
| 60 Hz | Sealing | VA | 4.4 |
| 60 Hz | Sealing | W | 1.4 |
| 50/60 Hz | Pick-up | VA | 27 25 |
| 50/60 Hz | Sealing | VA | 4.2 3.3 |
| 50/60 Hz | Sealing | W | 1.4 1.2 |
| DC operated | Pick-up | W | 4.5 |
| DC operated | Sealing | W | 4.5 |
| Duty factor | | % DF | 100 |
| Switching times at 100 % U_c (approximate values) | | | |
| Main contacts | | | |
| AC operated | | | |
| | | ms | 15 - 21 |
| | | ms | 9 - 18 |
| DC operated | | | |
| | | ms | 31 |
| | | ms | 12 |
| Arcing time | | | |
| | | ms | 10 |
| Lifespan, mechanical; Coil 50/60 Hz | | $\times 10^6$ | Mechanical lifespan at 50 Hz approx. 30% lower than under "Technical data, general" |
| Electromagnetic compatibility (EMC) | | | |
| Emitted interference | | | to EN 60947-1 |
| Interference immunity | | | to EN 60947-1 |

Data for design verification according to IEC/EN 61439

| | | | |
|--|------------|---|--|
| Technical data for design verification | | | |
| Rated operational current for specified heat dissipation | I_n | A | 12 |
| Heat dissipation per pole, current-dependent | P_{vid} | W | 0.3 |
| Equipment heat dissipation, current-dependent | P_{vid} | W | 0 |
| Static heat dissipation, non-current-dependent | P_{vs} | W | 1.4 |
| Heat dissipation capacity | P_{diss} | W | 0 |
| IEC/EN 61439 design verification | | | |
| 10.2 Strength of materials and parts | | | |
| 10.2.2 Corrosion resistance | | | |
| | | | Meets the product standard's requirements. |
| 10.2.3.1 Verification of thermal stability of enclosures | | | |
| | | | Meets the product standard's requirements. |
| 10.2.3.2 Verification of resistance of insulating materials to normal heat | | | |
| | | | Meets the product standard's requirements. |
| 10.2.3.3 Verification of resistance of insulating materials to abnormal heat and fire due to internal electric effects | | | |
| | | | Meets the product standard's requirements. |

| | | |
|--|--|--|
| 10.2.4 Resistance to ultra-violet (UV) radiation | | Meets the product standard's requirements. |
| 10.2.5 Lifting | | Does not apply, since the entire switchgear needs to be evaluated. |
| 10.2.6 Mechanical impact | | Does not apply, since the entire switchgear needs to be evaluated. |
| 10.2.7 Inscriptions | | Meets the product standard's requirements. |
| 10.3 Degree of protection of ASSEMBLIES | | Does not apply, since the entire switchgear needs to be evaluated. |
| 10.4 Clearances and creepage distances | | Meets the product standard's requirements. |
| 10.5 Protection against electric shock | | Does not apply, since the entire switchgear needs to be evaluated. |
| 10.6 Incorporation of switching devices and components | | Does not apply, since the entire switchgear needs to be evaluated. |
| 10.7 Internal electrical circuits and connections | | Is the panel builder's responsibility. |
| 10.8 Connections for external conductors | | Is the panel builder's responsibility. |
| 10.9 Insulation properties | | |
| 10.9.2 Power-frequency electric strength | | Is the panel builder's responsibility. |
| 10.9.3 Impulse withstand voltage | | Is the panel builder's responsibility. |
| 10.9.4 Testing of enclosures made of insulating material | | Is the panel builder's responsibility. |
| 10.10 Temperature rise | | The panel builder is responsible for the temperature rise calculation. Eaton will provide heat dissipation data for the devices. |
| 10.11 Short-circuit rating | | Is the panel builder's responsibility. The specifications for the switchgear must be observed. |
| 10.12 Electromagnetic compatibility | | Is the panel builder's responsibility. The specifications for the switchgear must be observed. |
| 10.13 Mechanical function | | The device meets the requirements, provided the information in the instruction leaflet (IL) is observed. |

Technical data ETIM 5.0

| | | |
|--|----|------------------|
| Low-voltage industrial components (EG000017) / Magnet contactor, AC-switching (EC000066) | | |
| Electric engineering, automation, process control engineering / Low-voltage switch technology / Contactor (LV) / Power contactor, AC switching (ecl@ss8-27-37-10-03 [AAB718011]) | | |
| Rated control supply voltage U_s at AC 50HZ | V | 230 - 230 |
| Rated control supply voltage U_s at AC 60HZ | V | 240 - 240 |
| Rated control supply voltage U_s at DC | V | 0 - 0 |
| Voltage type for actuating | | AC |
| Rated operation current I_e at AC-1, 400 V | A | 14 |
| Rated operation current I_e at AC-3, 400 V | A | 12 |
| Rated operation power at AC-3, 400 V | kW | 5.5 |
| Rated operation current I_e at AC-4, 400 V | A | 7 |
| Rated operation power I_e at AC-4, 400 V | kW | 3 |
| Modular version | | No |
| Number of auxiliary contacts as normally open contact | | 0 |
| Number of auxiliary contacts as normally closed contact | | 1 |
| Connection type main current circuit | | Screw connection |
| Number of normally closed contacts as main contact | | 0 |
| Number of main contacts as normally open contact | | 3 |

Approvals

| | | |
|--------------------------------------|--|---|
| Product Standards | | IEC/EN 60947-4-1; UL 508; CSA-C22.2 No. 14-05; CE marking |
| UL File No. | | E29096 |
| UL Category Control No. | | NLDX |
| CSA File No. | | 012528 |
| CSA Class No. | | 2411-03, 3211-04 |
| North America Certification | | UL listed, CSA certified |
| Specially designed for North America | | No |

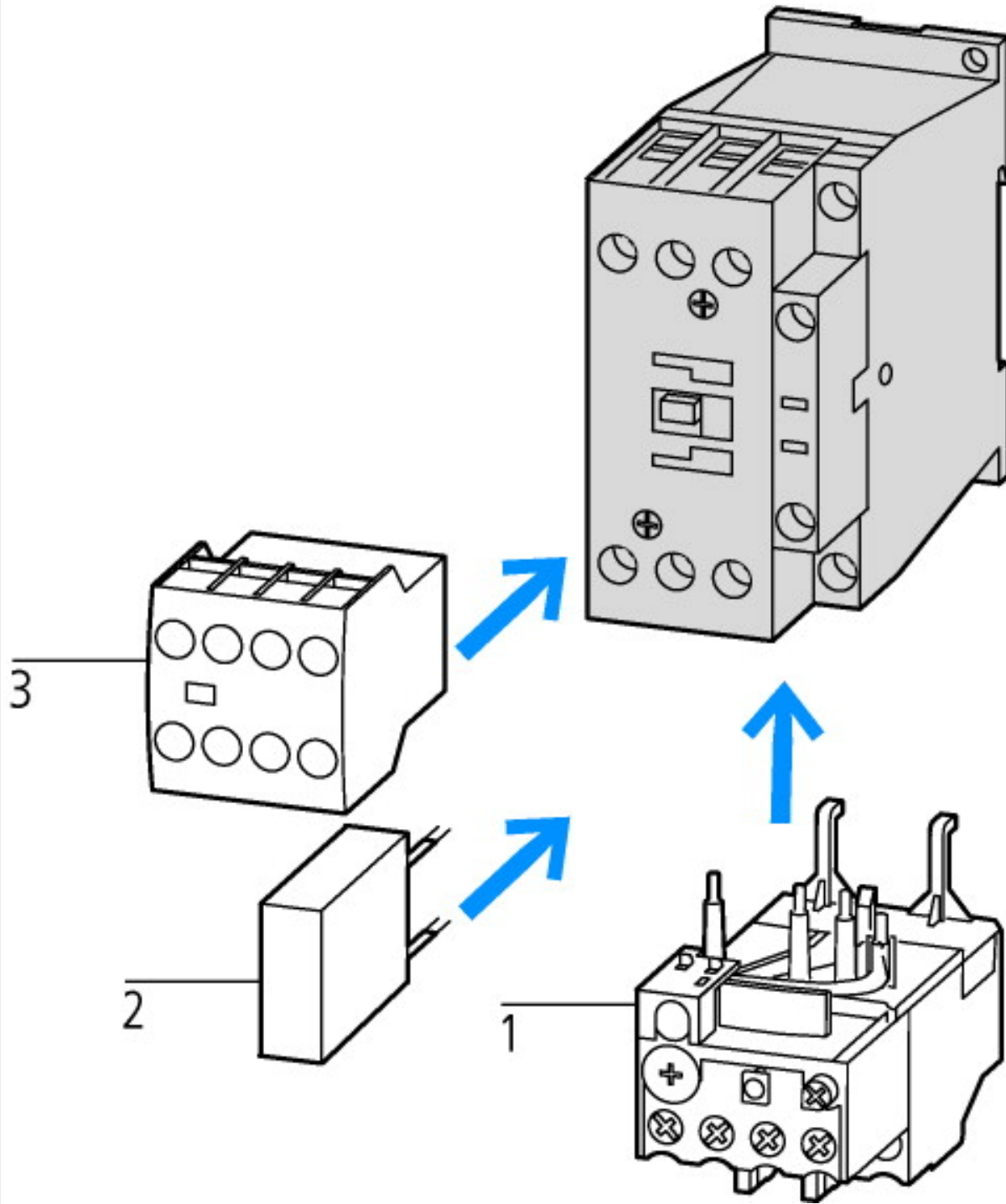

- 1: Overload relay
- 2: Suppressor
- 3: Auxiliary contact modules

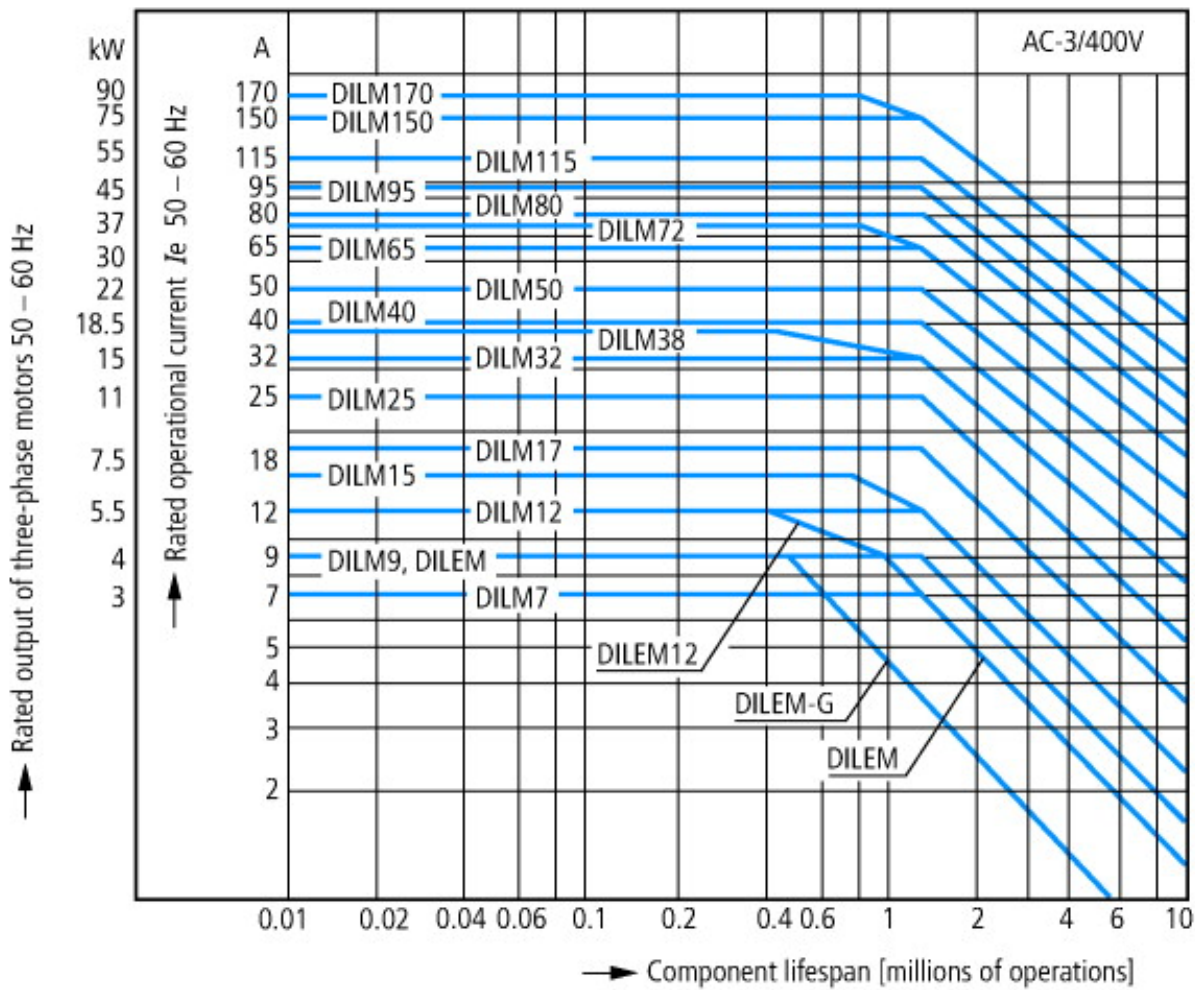

- Squirrel-cage motor
- Operating characteristics
- Starting: from rest
- Stopping: after attaining full running speed
- Electrical characteristics
- Make: up to 6 x rated motor current
- Break: up to 1 x rated motor current
- Utilization category
- 100 % AC-3
- Typical applications
- Compressors
- Lifts
- Mixers
- Pumps
- Escalators
- Agitators
- Fans
- Conveyor belts
- Centrifuges
- Hinged flaps
- Bucket-elevators
- Air conditioning system
- General drives in manufacturing and processing machines

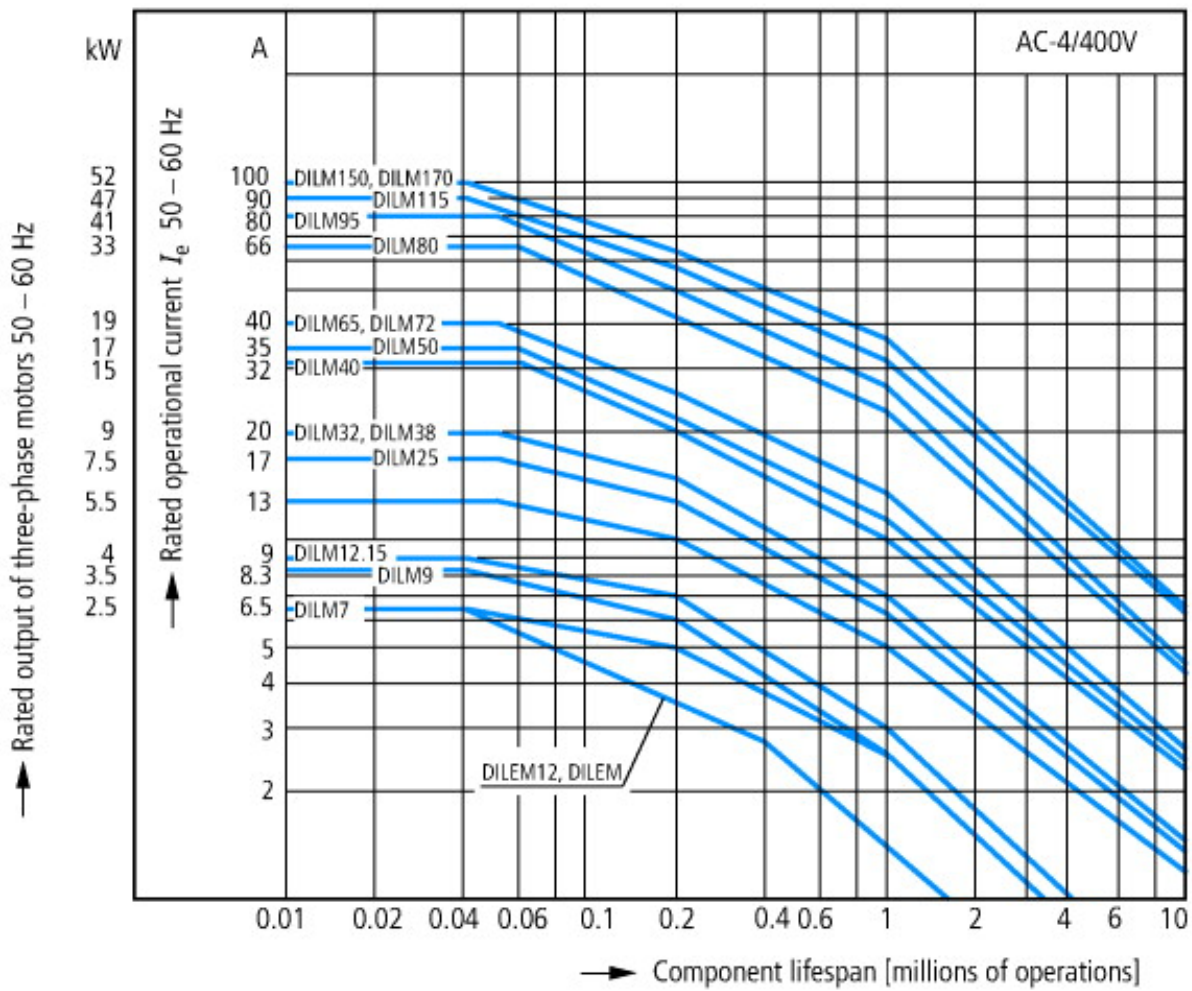

- Extreme switching duty
- Squirrel-cage motor
- Operating characteristics
- Inching, plugging, reversing
- Electrical characteristics
- Make: up to 6 x rated motor current
- Break: up to 6 x rated motor current
- Utilization category
- 100 % AC-4
- Typical applications
- Printing presses
- Wire-drawing machines
- Centrifuges
- Special drives for manufacturing and processing machines

Dimensions

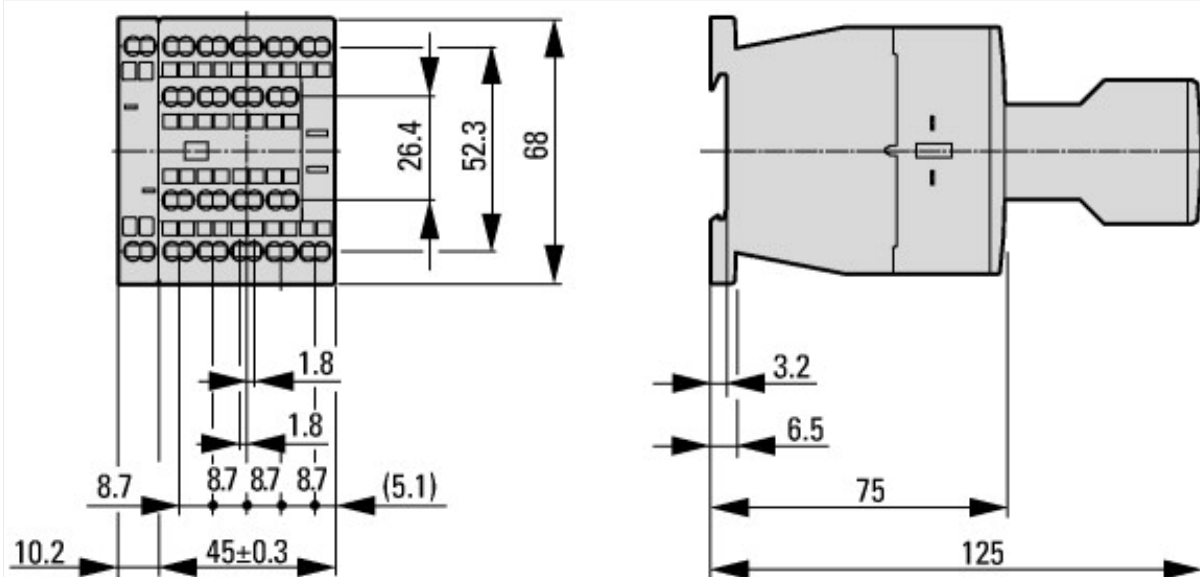

Contactor with auxiliary contact module

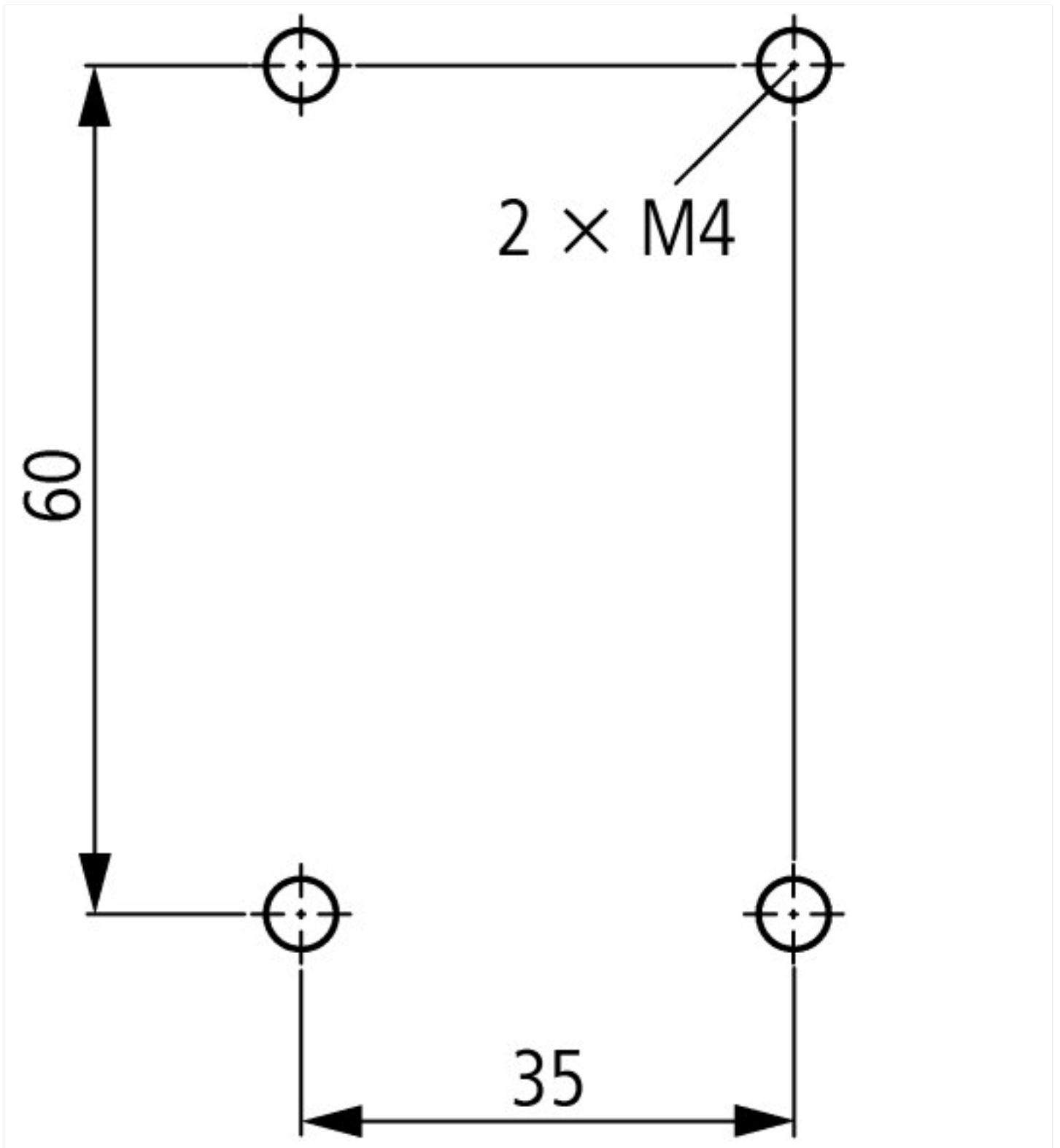

Additional product information (links)

IL03407013Z (AWA2100-2126) Contactors

| | |
|--|---|
| IL03407013Z (AWA2100-2126) Contactors | ftp://ftp.moeller.net/DOCUMENTATION/AWA_INSTRUCTIONS/IL03407013Z2012_03.pdf |
| UL/CSA: Approved rating data | http://de.ecat.moeller.net/flip-cat/?edition=HPLTE&startpage=5.84 |
| UL/CSA: UL/CSA: Special Purpose Rating | http://de.ecat.moeller.net/flip-cat/?edition=HPLTE&startpage=5.85 |
| UL/CSA: UL/CSA: Short Circuit Current Rating (SCCR) | http://de.ecat.moeller.net/flip-cat/?edition=HPLTE&startpage=5.86 |
| Switchgear of Power Factor Correction Systems | http://www.moeller.net/binary/ver_techpapers/ver934en.pdf |
| X-Start - Modern Switching Installations Efficiently Fitted and Wired Securely | http://www.moeller.net/binary/ver_techpapers/ver938en.pdf |
| Mirror Contacts for Highly-Reliable Information Relating to Safety-Related Control Functions | http://www.moeller.net/binary/ver_techpapers/ver944en.pdf |
| Effect of the Cable Capacitance of Long Control Cables on the Actuation of Contactors | http://www.moeller.net/binary/ver_techpapers/ver949en.pdf |

| | |
|--|---|
| Motor starters and "Special Purpose Ratings" for the North American market | http://www.moeller.net/binary/ver_techpapers/ver953en.pdf |
| Switchgear for Luminaires | http://www.moeller.net/binary/ver_techpapers/ver955en.pdf |
| Standard Compliant and Functionally Safe Engineering Design with Mechanical Auxiliary Contacts | http://www.moeller.net/binary/ver_techpapers/ver956en.pdf |
| The Interaction of Contactors with PLCs | http://www.moeller.net/binary/ver_techpapers/ver957en.pdf |
| Busbar Component Adapters for modern Industrial control panels | http://www.moeller.net/binary/ver_techpapers/ver960en.pdf |