

Part no. : 7614

Receptacle

switched, with mechanical DUO-interlock; can be padlocked

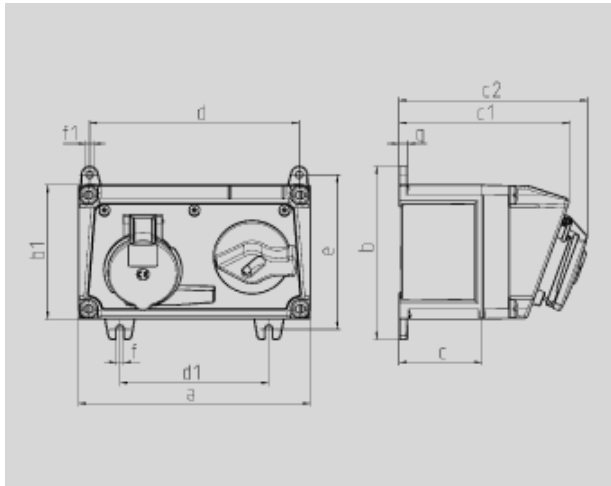

Drawing 1 MB 550	Amp. Poles	16			32		
		3	4	5	3	4	5
Dim. in mm	a	225	225	225	225	225	225
	b	168	168	168	168	168	168
	b1	130	130	130	130	130	130
	c	80	80	80	80	80	80
	c1	166	166	166	166	166	166
	c2	182	183	183	193	193	193
	d	204	204	204	204	204	204
	d1	145	145	145	145	145	145
	e	150	150	150	150	150	150
	f	7	7	7	7	7	7
	f1	Ø7	Ø7	Ø7	Ø7	Ø7	Ø7
	g	8	8	8	8	8	8

 Article-group : **1100**

voltages : 400V

rated current : 32A







pole : 4 pole

IP protection types : 44

position of ground contact : 6h

weight : 1524

PART NUMBERS

	V	110V	230V	400V	500V	>50-500V	
	Hz	50,60	50,60	50,60	50,60	100-300	300-500
	colour						
	amp.						
16 A	3	7602	7603				
	4		7604	7605	7606		
	5			7607			
32 A	3	7611	7612				
	4		7613	7614	7615		
	5			7616			