



68602-110HLF
68602-110HLF - BergStik® : Unshrouded Header, Through Hole, Double Row, 10 Positions, 2.54 mm Pitch, Vertical, 5.84 mm (0.23 in.) Mating, 3.81 mm (0.15 in.) Tail



Customer drawing



Environmental Compliance Report

[General](#)
[Dimensional](#)
[Electrical](#)
[Mechanical](#)
[Mounting](#)
[Physical](#)
[Approvals / Certifications](#)
[Other Features](#)

General

Number of contacts (per row)	5
Number of contacts (Total)	10
Number of rows	2
Orientation	Vertical
Packaging	Bulk Packaging
Attachment type (Board)	Through Hole
Series Number	68602
Dimensional	
Length (Mating pin)	5.84 mm (0.23 in.)
Length (Overall pin)	12.19 mm (0.48 in.)
Length (Tail)	3.81 mm (0.15 in.)
Electrical	
Current rating	3 amp Continuous
Resistance (Insulation)	5000 M-ohms
Voltage rating	1500V AC rms
Mechanical	
Retention force	8.88N (2 lbf)
Mounting	
Retention feature (Board)	No
Solder process	Vapor-phase IR Reflow Soldering Processes Compatible with Wave
Physical	
Color (Housing)	Black
Material (Contact)	Phospor Bronze
Material (Housing)	High Temperature Black Thermoplastic
Plating (Contact area)	0.76 µm (30 µin.) Gold or GXT
Plating (Tail)	0.76 µm (30 µin.) Gold or GXT, or Tin
Underplating (Contact)	1.27 µm (50 µin.) Nickel
Flammability rating	UL 94 V-0
Temperature (Range)	-65°C to +125°C
Approvals / Certifications	
UL File Number	E66906
CSA File Number	LR46923
Approvals / Certifications	UL and CSA Approved
Other Features	
Comments	Sample Kit 950501-016
Literature	950559-001

PRODUCT NUMBER

XXXXX-YYYHPLF

- LEAD FREE OPTION
SEE NOTE 1,13
- SPECIAL OPTIONS
SEE NOTE 1 OR 10
- HIGH TEMPERATURE PLASTIC
SEE NOTE 1
- NO OF POSITIONS
SEE NOTE 1
- PIN PLATING
SEE SHEET 2
- BASE PART NO.

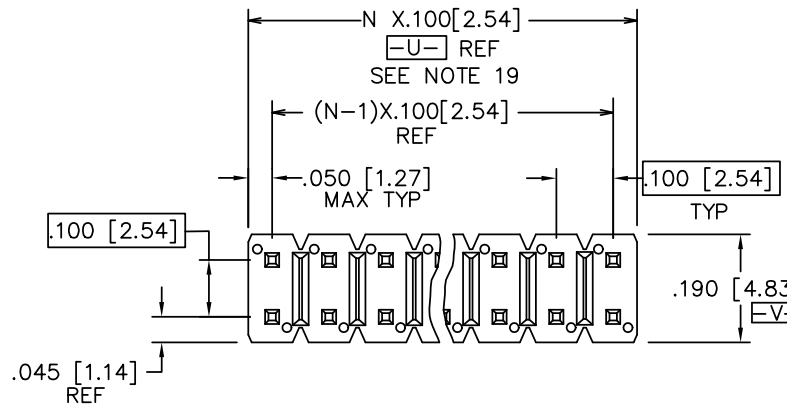

TOP VIEW

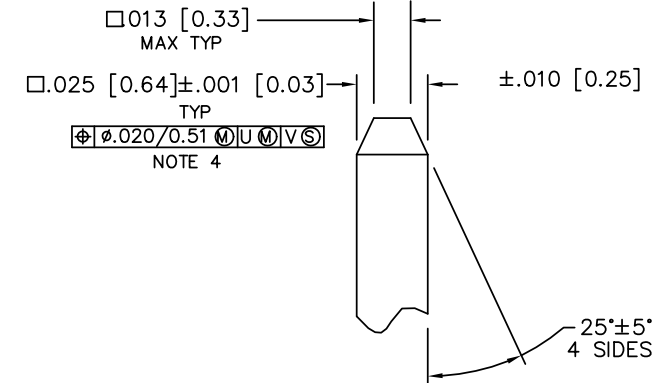

DETAIL P
SCALE 5:1
TYP BOTH ENDS

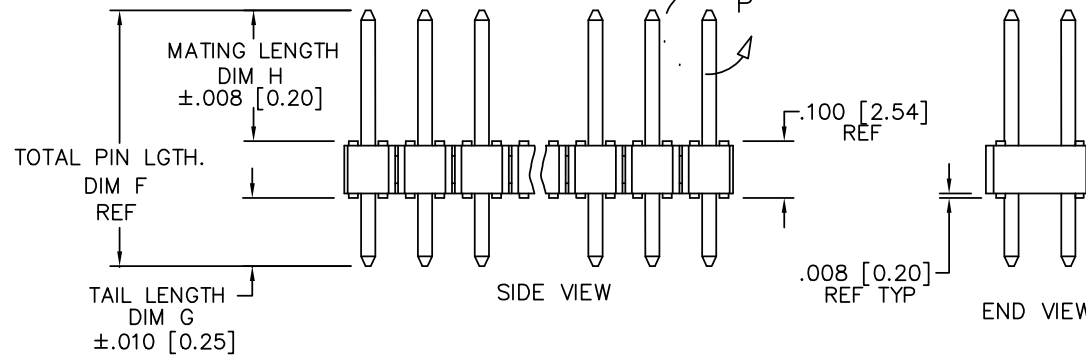

NOTE 6

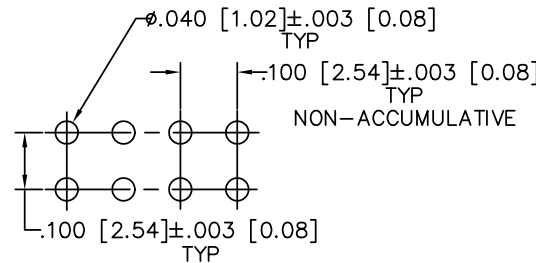

RECOMMENDED HOLE PATTERN

67996-X XX-XXX XXX LF

TAIL LENGTH (EXAMPLE BELOW)
3.0mm=030 12.8mm=128
(SEE NOTE 16 & 17)

MATING LENGTH (EXAMPLE BELOW)
5.0mm=050 25.5mm=255
(SEE NOTE 16 & 17)

TOTAL NUMBER OF POSITIONS
FROM 2 (2X1) THRU 72 (2X36) POS.

PIN PLATING (SEE NOTE 14)
1=0.76µm Au
4= PURE TIN
8=0.36µm Au

BASE PART NO.
DOUBLE ROW

mat'l. code NOTE 2 & 3				surface ISO 1302 ✓		tolerance ISO 406 ISO 1101		projection INCH/MM		product family BERGSTIK	
ltr	ecn no	dr	date	tolerances unless otherwise specified				title			
DF	N11-0180	J.Z	2011-05-31	angles	linear	.XX±.01/.XX±.3		BERGSTIK II HEADER D/R			
DG	ELX-N-13471	J.Z	2011-11-16	0°±2'		.XXX±0.005/.XXX±.13		.100/2.54cc STRAIGHT			
						.XXX±0.020/.XXX±.05		scale 2:1			
				dr	T.BREWBAKER	12/21/94		dwg no sheet 1 of 8 size			
				engr	T.HANNA	12/21/94		67996 A3			
				chr	J.MURPHY	12/21/94		type Product Customer Drawing			
				appd	T.HANNA	12/21/94					
sheet index	revision sheet	DG	...	DG							
		1	...	8							

PIN PLATING CODES:	
XXXX-1YY	30u"/0.76u MIN (SEE NOTE 14) OVER 50u"/1.27u MIN Ni
XXXX-2YY	15u"/0.38u MIN (SEE NOTE 14) OVER 50u"/1.27u MIN Ni
XXXX-3YY	50u"/1.27u MIN (SEE NOTE 14) OVER 50u"/1.27u MIN Ni
XXXX-4YY	100u"/2.54u MIN Sn OVER 50u"/1.27u MIN Ni (SEE NOTE 15)
XXXX-4YYHLF	
XXXX-5YY	15u"/0.38u MIN (SEE NOTE 14) OVER 50u"/1.27u MIN Ni
XXXX-6YY	30u"/0.76u MIN (SEE NOTE 14) OVER 50u"/1.27u MIN Ni
XXXX-7YY	30u"/0.76u MIN (SEE NOTE 14) OVER 50u"/1.27u MIN Ni
XXXX-8YY	15u"/0.38u MIN (SEE NOTE 14) OVER 50u"/1.27u MIN Ni
XXXX-9YY	15u"/0.38u MIN (SEE NOTE 14) OVER 50u"/1.27u MIN Ni
XXXX-0YY	30u"/0.76u MIN (SEE NOTE 14) OVER 50u"/1.27u MIN Ni

- PIN MATERIAL: PHOS BRONZE.
- MEASURED WITH PART IN RESTRAINED CONDITION.
- TWO SIDES OF PIN TIPS NOT PLATED. TYPICAL BOTH ENDS.
- 2LBS/0.9KG MIN PIN RETENTION IN EITHER DIRECTION.
- MILITARY BERGSTIK HEADER
P/N XXXXX-XYX-MIL
NOT AVAILABLE.
- ±.010/0.25 TOL APPLIES TO ALL "G" TAILS EXCEPT INDICATED PARTS ON TABLE WHERE +.010/0.25 -.000/0.00 APPLIES.
- NOTCH CONFIGURATION WILL VARY PER VENDOR'S DISCRETION.
- BERGSTRIPTM PART NUMBERS FOLLOWED BY BY A "B" ARE BULK PRICED.
- TAIL LENGTH (DIM. G) TO BE ±.008/.020.
- POSITIONS PER ROW 37 TO 50 CAN BE PRODUCED, BUT FLATNESS AND CURVATURE MAY NOT BE HELD AS CLOSE AS 36 POSITIONS.
- THESE PRODUCTS MEETS EUROPEAN UNION DIRECTIVES AND OTHER COUNTRY REGULATION AS DESCRIBED IN GS-22-008.
- PLATING OPTIONS:
PERFORMANCE PLATING WILL BE EITHER GOLD OR GXT ON POST OR TAIL, OPTIONALLY (78~295u"/2~7.5u) TIN ON TAIL.
- "THIS PRODUCT HAS 100% TIN PLATING IN THE INTERFACE AND HAS NOT BEEN TESTED FOR WHISKER GROWTH IN ALL INTERCONNECT ENVIRONMENTS."
- THE OAL DON'T EXCEED 34.5mm
- INCREMENTS BY 0.1mm IN LENGTHS ONLY
- FOR SPECIAL PACKAGING REQUEST PLEASE CONTACT PRODUCT MANAGER FOR AVAILABILITY
- TO DETERMINE DIMENSIONS:
N=NUMBER OF POSITION PER ROW
EXAMPLE: 10 POS. N X .100/2.54

NOTES

1. PART NUMBER OPTIONS:
PIN PLATING CODES (SEE ABOVE)

HIGH TEMPERATURE MATERIAL:

PART NUMBERS WITH AND WITHOUT "H" WILL BE SUPPLIED WITH HIGH TEMPERATURE PLASTIC.

NUMBER OF POSITIONS :

EVEN NUMBER OF POSITIONS FROM 2 (2X1) THROUGH 72 (2X36).
-X00H INDICATES BERGSTRIPTM PRODUCT. SEE PAGE 3
FOR SPECIAL GEOMETRY OF THIS CONTINUOUS STRIP PRODUCT.
AUTOMATED REELS WILL CONTAIN 45,000 PINS.
SEE SPECIFIC PART NUMBERS FOR AVAILABILITY.

PACKAGING:

PACKAGED IN POLY BAGS.
EIGHT DIGIT PART NUMBERS FOLLOWED BY A "T" ARE PACKAGED IN TUBES. SEE SPECIFIC PART NUMBERS FOR AVAILABILITY.
EIGHT DIGIT PART NUMBERS FOLLOWED BY A "G" ARE PACKAGED IN GPAX FOR IBM ONLY. SEE SPECIFIC PART NUMBERS FOR AVAILABILITY.
PART NUMBERS FOLLOWED BY A "C" ARE PACKAGED IN TUBES WITH A PICKUP CAP APPLIED.
EIGHT DIGIT PART NUMBERS FOLLOWED BY A "A" ARE PACKAGED IN TAPE/REEL WITH PICKUP CAP P/N 95730-003 APPLIED, PER BUS-14-345.

LEAD FREE:

ADD "HLF" SUFFIX AT THE END OF PART NUMBER FOR LEAD FREE OPTION, NOT AVAILABLE FOR -5YY,-5YYH, -6YY & -6YYH

2. BODY MATERIAL:

BODY MATERIAL : MANUFACTURER'S OPTION OF NYLON, PCT GLASS FIBER REINFORCED OR MINERAL FILLED LCP FLAME RETARDENT PER UL-94V-0.
COLOR: BLACK
BERGSTRIPTM PRODUCED WITH HIGH TEMPERATURE LCP THERMOPLASTIC, FLAME RETARDENT PER UL-94V-0.
COLOR: BLACK
PART NUMBERS WITH "H" AND WITHOUT SUFFIX WILL WITHSTAND EXPOSURE TO 260° C PEAK TEMPERATURE FOR 20 SECONDS IN WAVE SOLDER, INFRA-RED OR VAPOR PHASE SOLDER PROCESS.

mat'l. code		surface		tolerance		projection		product family	
NOTE 2 & 3		ISO 1302 ✓		ISO 406		ISO 1101		BERGSTIK	
ltr	ecn	no	dr	date	tolerances unless otherwise specified		INCH/MM	title	
DG					angles	linear		scale 2:1	BERGSTIK II HEADER D/R
					0°±2'	.XXX±0.006/XXX±.13			.100/2.54cc STRAIGHT
					dr	T.BREWBAKER	12/21/94	dwg no	
					enrg	T.HANNA	12/21/94	sheet 2 of 8 size	
					chr	J.MURPHY	12/21/94	67996 A3	
					appd	T.HANNA	12/21/94	type Product Customer Drawing	
sheet index	revision sheet								

BERGSTRIPTM HEADER

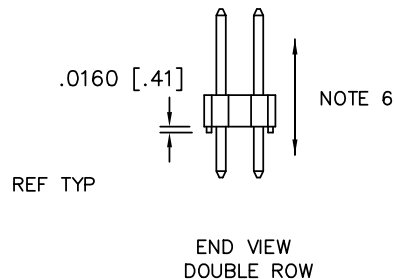
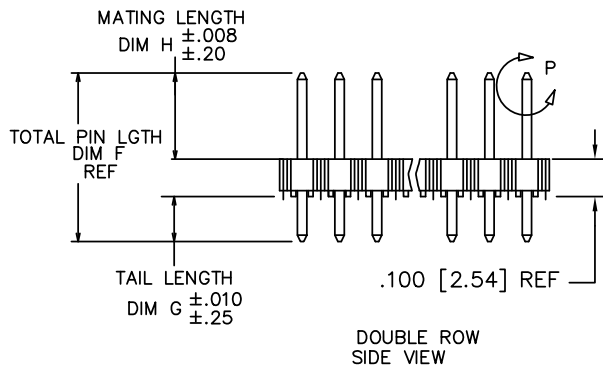
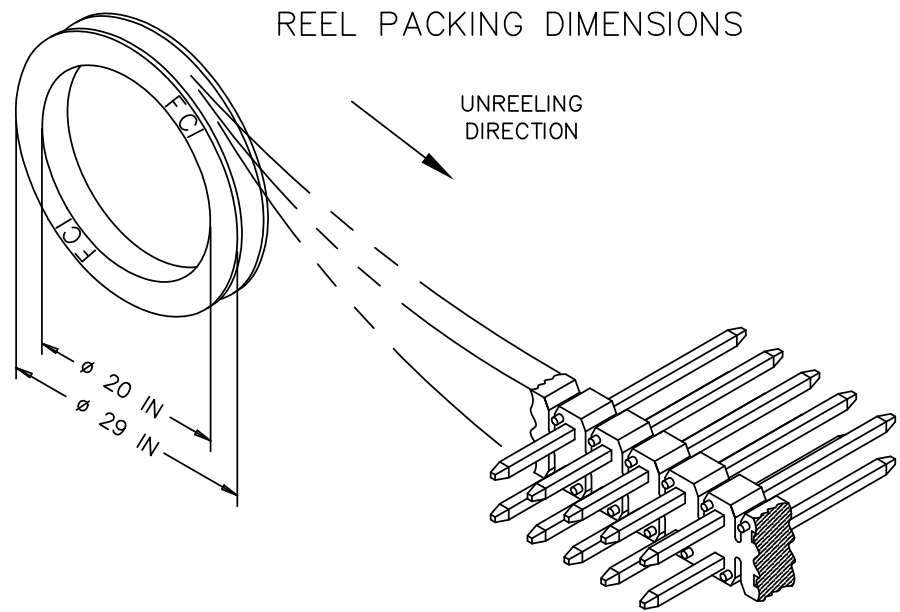
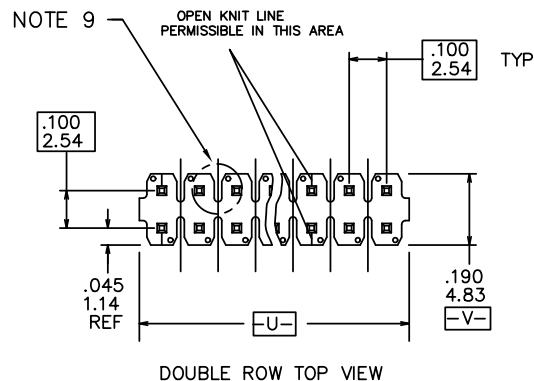

mat'l. code NOTE 2 & 3		surface ISO 1302 ✓	tolerance ISO 406 ISO 1101	projection INCH/MM	product family BERGSTIK
ltr	ecn no	dr	date	tolerances unless otherwise specified	title
DG				linear XX±01/XX±3 XXX±0.005/XXX±.13 XXXX±0020/XXX±.05	BERGSTIK II HEADER D/R .100/2.54cc STRAIGHT
				0°±2'	scale 2:1
		dr	T.BREWBAKER	12/21/94	dwg no
		enr	T.HANNA	12/21/94	sheet 3 of 8
		chr	J.MURPHY	12/21/94	size
		appd	T.HANNA	12/21/94	67996
					A3
					type Product Customer Drawing
sheet index	revision sheet				

PRODUCT NUMBER	1 TOT. PIN LGTH.		TAIL LENGTH		2 3 MATING LENGTH		PACKAGING	NOTES	BERGSTRIIP™ AVAILABLE	LF OPTION
	DIM F	DIM F	DIM G	DIM G	DIM H	DIM H				
	ENGLISH	METRIC	ENGLISH	METRIC	ENGLISH	METRIC				
55005-XYH	0.597	15.16	0.095	2.41	0.402	10.21	POLY BAGS	-	YES	NOTE 1,13
55030-XYH	0.630	16.00	0.150	3.81	0.380	9.65	POLY BAGS	-	YES	
67996-XYH	0.425	10.80	0.095	2.41	0.230	5.84	POLY BAGS/TUBES	-	YES	
67997-XYH	0.450	11.43	0.120	3.05	0.230	5.84	POLY BAGS/TUBES	-	YES	
67997-XYH	0.450	11.43	0.120	3.05	0.230	5.84	POLY BAGS/TUBES	-	YES	
67998-XYH	0.525	13.34	0.107	2.72	0.318	8.08	POLY BAGS/TUBES	-	YES	
67999-XYH	0.548	13.92	0.130	3.30	0.318	8.08	POLY BAGS	-	NO	
68438-XYH	0.555	14.10	0.225	5.72	0.230	5.84	POLY BAGS/TUBES	-	NO	
68439-XYH	0.720	18.29	0.120	3.05	0.500	12.70	POLY BAGS	-	NO	
68464-XYH	0.650	16.51	0.120	3.05	0.430	10.92	POLY BAGS/TUBES	-	NO	
68481-XYH	0.480	12.19	0.095	2.41	0.285	7.24	POLY BAGS/TUBES	-	NO	
68482-XYH	0.938	23.83	0.318	8.08	0.520	13.21	POLY BAGS	-	NO	
68491-XYH	0.475	12.07	0.120	3.05	0.255	6.48	POLY BAGS/TUBES	-	NO	
68600-XYH	0.825	20.96	0.115	2.92	0.610	15.49	POLY BAGS	-	NO	
68601-XYH	0.620	15.75	0.120	3.05	0.400	10.16	POLY BAGS	-	NO	
68602-XYH	0.480	12.19	0.150	3.81	0.230	5.84	POLY BAGS	-	YES	
68690-XYH	0.533	13.54	0.115	2.92	0.318	8.08	POLY BAGS	-	NO	
68691-XYH	0.538	13.67	0.120	3.05	0.318	8.08	POLY BAGS	-	YES	
68692-XYH	0.430	10.92	0.100	2.54	0.230	5.84	POLY BAGS	-	NO	
68693-XYH	0.938	23.83	0.520	13.21	0.318	8.08	POLY BAGS	-	NO	
68716-XYH	0.828	21.03	0.410	10.41	0.318	8.08	POLY BAGS	-	NO	
68734-XYH	0.615	15.62	0.230	5.84	0.285	7.24	POLY BAGS	-	NO	
68737-XYH	0.440	11.18	0.110	2.79	0.230	5.84	POLY BAGS	-	YES	
68738-XYH	0.615	15.62	0.115	2.92	0.400	10.16	POLY BAGS	-	NO	
68739-XYH	0.486	12.34	0.156	3.96	0.230	5.84	POLY BAGS	-	NO	
68743-XYH	0.638	16.21	0.220	5.59	0.318	8.08	POLY BAGS	-	NO	
68749-XYH	0.838	21.29	0.420	10.67	0.318	8.08	POLY BAGS	-	NO	
68779-XYH	0.736	18.69	0.318	8.08	0.318	8.08	POLY BAGS	-	NO	
68783-XYH	0.375	9.53	0.045	1.14	0.230	5.84	POLY BAGS	-	NO	
68799-XYH	0.925	23.50	0.595	15.11	0.230	5.84	POLY BAGS	-	NO	

B
FCconnect.com

C

D

mat'l. code NOTE 2 & 3		surface ISO 1302 ✓	tolerance ISO 406 ISO 1101	projection 	product family BERGSTIK
ltr	ecn no	dr	date	tolerances unless otherwise specified	title
DG				angles linear 0°±2'	BERGSTIK II HEADER D/R .100/2.54cc STRAIGHT
				linear XXX±0.006/XXX±.13 XXXX±0.020/XXXX±.05	INCH/MM scale 2:1
		dr	T.BREWBAKER	12/21/94	dwg no
		enrg	T.HANNA	12/21/94	sheet 4 of 8 size
		chr	J.MURPHY	12/21/94	67996 A3
		appd	T.HANNA	12/21/94	type Product Customer Drawing
sheet index	revision sheet				

PRODUCT NUMBER	TOT. PIN LGTH.		TAIL LENGTH		MATING LENGTH		PACKAGING	NOTES	BERGSTRIPTM AVAILABLE	LF OPTION
	DIM F	DIM F	DIM G	DIM G	DIM H	DIM H				
69132-YYY	0.760	19.30	0.120	3.05	0.540	13.72	POLY BAGS/TUBES	-	NO	NOTE 1,13
69133-YYY	0.615	15.62	0.285	7.24	0.230	5.84	POLY BAGS	-	NO	
69157-YYY	0.410	10.41	0.110	2.79	0.200	5.08	POLY BAGS	-	NO	
71217-XXYH	1.000	25.40	0.450	11.43	0.450	11.43	POLY BAGS	-	NO	
71222-XXYH	0.850	21.59	0.250	6.35	0.500	12.70	POLY BAGS	-	NO	
72273-XXYH	0.725	18.42	0.110	2.79	0.515	13.08	POLY BAGS	-	NO	
72448-XXYH	0.658	16.71	0.172	4.37	0.386	9.80	POLY BAGS	-	NO	
72455-XXYH	0.598	15.19	0.180	4.57	0.318	8.08	POLY BAGS	-	NO	
72455-632HG	0.598	15.19	0.180	4.57	0.318	8.08	GPAX	NOTE 1	NO	
73503-XXYH	0.420	10.67	0.120	3.05	0.200	5.08	POLY BAGS	-	NO	
73596-XXYH	0.795	20.19	0.110	2.79	0.585	14.86	POLY BAGS	-	NO	
74317-XXYH	0.532	13.51	0.309	7.85	0.123	3.12	POLY BAGS	NOTE 11	NO	
74318-XXYH	0.592	15.04	0.369	9.37	0.123	3.12	POLY BAGS	NOTE 11	NO	
74999-XXYH	0.508	12.90	0.090	2.29	0.318	8.08	POLY BAGS	-	NO	
78212-XXY	0.710	18.03	0.350	8.89	0.260	6.60	POLY BAGS	-	NO	
78233-XXY	0.568	14.43	0.150	3.81	0.318	8.08	POLY BAGS	-	NO	
78269-XXY	0.385	9.78	0.095	2.41	0.190	4.83	POLY BAGS	-	NO	
78286-XXY	0.500	12.70	0.160	4.06	0.240	6.10	POLY BAGS/TUBES	-	NO	
78932-XXY	UNAVAILAB	E	UNAVAILAB	E	UNAVAILAB	E		-	-	
78933-XXY	0.695	17.65	0.285	7.24	0.310	7.87	POLY BAGS	-	NO	
78988-XXY	0.540	13.72	0.135	3.43	0.305	7.75	POLY BAGS	-	NO	
78989-XXY	UNAVAILAB	E	UNAVAILAB	E	UNAVAILAB	E		-	-	
78990-XXY	UNAVAILAB	E	UNAVAILAB	E	UNAVAILAB	E		-	-	
78991-XXY	UNAVAILAB	E	UNAVAILAB	E	UNAVAILAB	E		-	-	
78992-XXY	UNAVAILAB	E	UNAVAILAB	E	UNAVAILAB	E		-	-	
78993-XXY	UNAVAILAB	E	UNAVAILAB	E	UNAVAILAB	E		-	-	
78994-XXY	UNAVAILAB	E	UNAVAILAB	E	UNAVAILAB	E		-	-	

NOTE 1,13

mat'l. code NOTE 2 & 3		surface ISO 1302 ✓	tolerance ISO 406 ISO 1101	projection 	product family BERGSTIK
ltr	ecn no	dr	date	tolerances unless otherwise specified	title
DG				linear XX±0.10/XX±.3 XXX±0.005/XXX±.13 XXXX±0.020/XXXX±.05	BERGSTIK II HEADER D/R .100/2.54cc STRAIGHT
				angles 0°±2'	INCH/MM scale 2:1
		dr	T.BREWBAKER	12/21/94	dwg no
		enr	T.HANNA	12/21/94	sheet 5 of 8
		chr	J.MURPHY	12/21/94	size 67996 A3
		appd	T.HANNA	12/21/94	type Product Customer Drawing
sheet index	revision sheet				

PRODUCT NUMBER	TOT. PIN LGTH.		TAIL LENGTH		MATING LENGTH		PACKAGING	NOTES	BERGSTRIPTM AVAILABLE	LF OPTION
	DIM F	DIM F	DIM G	DIM G	DIM H	DIM H				
	ENGLISH	METRIC	ENGLISH	METRIC	ENGLISH	METRIC				
78995-XYY	UNAVAILABLE		UNAVAILABLE		UNAVAILABLE		E	-	-	NOTE 1,13
78996-XYY	UNAVAILABLE		UNAVAILABLE		UNAVAILABLE		E	-	-	
79242-XYY	0.930	23.62	0.340	8.64	0.490	12.45	POLY BAGS	-	NO	
79243-XYY	1.230	31.24	0.390	9.91	0.740	18.80	POLY BAGS	-	NO	
79244-XYY	UNAVAILABLE		UNAVAILABLE		UNAVAILABLE		E	-	-	
79268-XYY	1.020	25.91	0.120	3.05	0.800	20.32	POLY BAGS	-	NO	
79271-XYY	1.100	27.94	0.500	12.70	0.500	12.70	POLY BAGS	-	NO	
79425-XYY	0.410	10.41	0.120	3.05	0.190	4.83	POLY BAGS	-	NO	
79821-XYY	0.730	18.54	0.200	5.08	0.430	10.92	POLY BAGS	-	NO	
84610-XYYH	0.380	9.65	0.120	3.05	0.160	4.06	POLY BAGS	-	NO	
84760-XYYH	0.870	22.09	0.150	3.81	0.620	15.74	POLY BAGS	-	NO	
84784-XYYH	1.130	28.70	0.122	3.09	0.908	23.06	POLY BAGS	-	NO	
84934-XYYH	1.375	34.93	0.625	15.88	0.650	16.51	POLY BAGS	-	NO	
84976-XYYH	0.730	18.54	0.400	10.16	0.230	5.84	POLY BAGS	-	NO	
86503-XYY	0.470	11.94	0.120	3.05	0.250	6.35	POLY BAGS	-	NO	
86581-XYY	0.450	11.43	0.120	3.05	0.230	5.84	POLY BAGS	NOTE 8	NO	
86817-XYY	0.925	23.50	0.120	3.05	0.705	17.91	POLY BAGS	-	NO	
86827-XYY	0.700	17.78	0.120	3.05	0.480	12.19	POLY BAGS	-	NO	
86832-XYY	0.525	13.34	0.100	2.54	0.325	8.26	POLY BAGS	-	NO	
86834-XYY	1.335	33.91	0.585	14.86	0.650	16.51	POLY BAGS	-	NO	
86836-XYY	0.870	22.10	0.120	3.05	0.650	16.51	POLY BAGS	-	NO	
86837-XYY	0.600	15.24	0.120	3.05	0.380	9.65	POLY BAGS	-	NO	
87037-XYY	1.240	31.50	0.120	3.05	1.020	25.91	POLY BAGS	-	NO	
87052-XYY	0.990	25.15	0.120	3.05	0.770	19.56	POLY BAGS	-	NO	
87203-XYY	0.545	13.84	0.150	3.81	0.295	7.49	POLY BAGS	-	NO	
87344-XYY	1.375	34.93	0.219	5.56	1.056	26.82	POLY BAGS	-	NO	

mat'l. code NOTE 2 & 3		surface ISO 1302 ✓	tolerance ISO 406 ISO 1101	projection 	product family BERGSTIK
ltr	ecn no	dr	date	tolerances unless otherwise specified	title
DG				linear	BERGSTIK II HEADER D/R .100/2.54cc STRAIGHT
				angles	INCH/MM
				0°±2'	scale 2:1
		dr	T.BREWBAKER	12/21/94	
		enr	T.HANNA	12/21/94	
		chr	J.MURPHY	12/21/94	
		appd	T.HANNA	12/21/94	
sheet index	revision sheet				dwg no 67996 sheet 6 of 8 size A3 type Product Customer Drawing

PRODUCT NUMBER	TOT. PIN LGTH.		TAIL LENGTH		MATING LENGTH		PACKAGING	NOTES	BERGSTRIPTM AVAILABLE
	DIM F	DIM F	DIM G	DIM G	DIM H	DIM H			
	ENGLISH	METRIC	ENGLISH	METRIC	ENGLISH	METRIC			
87345-YYY	1.218	30.94	0.406	10.31	0.712	18.08	POLY BAGS	-	NO
87348-YYY	0.930	23.62	0.100	2.54	0.730	18.54	POLY BAGS	-	NO
87349-YYY	0.890	22.61	0.110	2.79	0.680	17.27	POLY BAGS	-	NO
87381-YYY	0.645	16.38	0.100	2.54	0.445	11.30	POLY BAGS	-	NO
87382-YYY	0.675	17.15	0.100	2.54	0.475	12.07	POLY BAGS	-	NO
87503-XXYH	0.630	16.00	0.110	2.79	0.420	10.67	POLY BAGS	-	NO
87869-YYY	0.690	17.53	0.230	5.84	0.360	9.14	POLY BAGS	-	NO
87894-YYY	0.588	14.94	0.170	4.32	0.318	8.08	POLY BAGS	-	NO
87900-YYY	0.940	23.88	0.120	3.05	0.720	18.29	POLY BAGS	-	NO
87901-YYY	1.040	26.42	0.120	3.05	0.820	20.83	POLY BAGS	-	NO
87903-YYY	0.963	24.46	0.337	8.56	0.526	13.36	POLY BAGS	-	NO
88797-YYY	0.950	24.13	0.320	8.13	0.530	13.46	POLY BAGS	-	NO
88812-YYY	0.415	10.54	0.085	2.16	0.230	5.84	POLY BAGS/TUBES	NOTE 8	NO
88886-YYY	1.306	33.17	0.276	7.01	0.930	23.62	POLY BAGS	-	NO
89446-YYY	0.930	23.62	0.120	3.05	0.710	18.03	POLY BAGS	-	NO
89540-YYY	0.760	19.30	0.280	7.11	0.380	9.65	POLY BAGS	-	NO
89542-YYY	1.065	27.05	0.125	3.18	0.840	21.34	POLY BAGS	-	NO
89639-YYY	1.260	32.00	0.118	3.00	1.042	26.47	POLY BAGS	-	NO
91828-YYY	0.450	11.43	0.120	3.05	0.230	5.84	TUBES	-	NO
92417-YYY	0.530	13.46	0.110	2.79	0.320	8.13	POLY BAGS	-	NO
93216-XXYH	0.573	14.55	0.155	3.94	0.318	8.08	POLY BAGS/TUBES	-	NO
93216-632HG	0.573	14.55	0.155	3.94	0.318	8.08	GPAX	NOTE 1	NO
93217-XXYH	0.395	10.03	0.095	2.41	0.200	5.08	POLY BAGS	-	NO
93254-YYY	0.563	14.30	0.110	2.79	0.353	8.97	POLY BAGS	-	NO

NOTE 1,13

NOTE 1,13

mat'l. code NOTE 2 & 3		surface ISO 1302 ✓	tolerance ISO 406 ISO 1101	projection 	product family BERGSTIK
ltr	ecn no	dr	date	tolerances unless otherwise specified	title BERGSTIK II HEADER D/R .100/2.54cc STRAIGHT
DG				linear XX±01/XX±3 XXX±0.005/XXX±.13 XXXX±.0020/XXX±.05	INCH/MM scale 2:1
				dr T.BREWBAKER 12/21/94	dwg no 67996 sheet 7 of 8 size A3
				enr T.HANNA 12/21/94	
				chr J.MURPHY 12/21/94	
				appd T.HANNA 12/21/94	type Product Customer Drawing
sheet index	revision sheet				



Copyright FCI

PRODUCT NUMBER	TOT. PIN LGTH.		TAIL LENGTH		MATING LENGTH		BERGSTRIK		LF OPTION	
	DIM F	DIM F	DIM G	DIM G	DIM H	DIM H	PACKAGING	NOTES		AVAILABLE
	ENGLISH	METRIC	ENGLISH	METRIC	ENGLISH	METRIC				
94010-XYH	0.756	19.20	0.350	8.89	0.306	7.77	POLY BAGS	-	NO	
94532-XYH	1.250	31.75	0.450	11.43	0.700	17.78	POLY BAGS	-	NO	
95105-XYH	0.370	9.40	0.126	3.20	0.144	3.66	POLY BAGS	-	NO	
95645-XYH	0.350	8.89	0.100	2.54	0.150	3.81	POLY BAGS	-	NO	
95652-XYH	0.500	12.70	0.070	1.78	0.330	8.38	POLY BAGS	-	NO	
95665-XYH	0.835	21.21	0.335	8.51	0.400	10.16	POLY BAGS	-	NO	
95687-XYH	0.820	20.83	0.360	9.14	0.360	9.14	POLY BAGS	-	NO	
95712-XYH	1.090	27.69	0.110	2.79	0.880	22.35	POLY BAGS	-	NO	
95727-XYH	0.825	20.96	0.110	2.79	0.615	15.62	POLY BAGS	-	NO	
98181-XYH	0.760	19.30	0.218	5.54	0.442	11.23	POLY BAGS	-	NO	
98217-XYH	0.756	19.20	0.328	8.33	0.328	8.33	POLY BAGS	-	NO	
98329-XYH	0.930	23.62	0.415	10.54	0.415	10.54	POLY BAGS	-	NO	
98854-XYH	0.450	11.43	0.120	3.05	0.230	5.84	TUBES	-	NO	
10017852-XYH	0.450	11.43	0.125	3.18	0.225	5.72	POLYBAGS	-	NO	
10074747-XYH	0.850	21.59	0.520	13.21	0.230	5.84	POLYBAGS	-	NO	

NOTE 1,13
↓
NOTE 1,13



Copyright FCI

mat'l. code NOTE 2 & 3		surface ISO 1302 ✓	tolerance ISO 406 ISO 1101	projection 	product family BERGSTIK
ltr	ecn no	dr	date	tolerances unless otherwise specified	title
DG				linear XX±0.1/XX±.3 XXX±0.006/XXX±.13 XXXX±0.020/XXX±.05	BERGSTIK II HEADER D/R .100/2.54cc STRAIGHT
				angles 0°±2'	INCH/MM scale 2:1
		dr	T.BREWBAKER	12/21/94	dwg no
		enr	T.HANNA	12/21/94	sheet 8 of 8 size
		chr	J.MURPHY	12/21/94	67996 A3
		appd	T.HANNA	12/21/94	type Product Customer Drawing
sheet index	revision sheet				