

Product Information



TOP250x50-Ø20

EAN 4031582366266

Wheel centre made of Polyamide, heavy duty,
precision ball bearing

Technical Data

| | |
|------------------------|----------------|
| Wheel diameter | 250 mm |
| Width of Tread | 50 mm |
| Axle Hole-Ø | 20 mm |
| Hub length | 60 mm |
| Temperature | - 40 / + 80 °C |
| Standard | EN 12533 |
| Weight | 1.883 kg |
| Hardness of tread | D 75 Shore |
| Bearing type | 6205 No. |
| Load capacity | 1100 kg |
| Load capacity (static) | 2200 kg |



| | | | | | |
|----------------------|---|---|---|---|---|
| Roll performance | + | + | + | + | + |
| Movement noise | + | + | + | + | + |
| Attrition | + | + | + | + | + |
| Corrosion resistance | + | + | + | + | + |

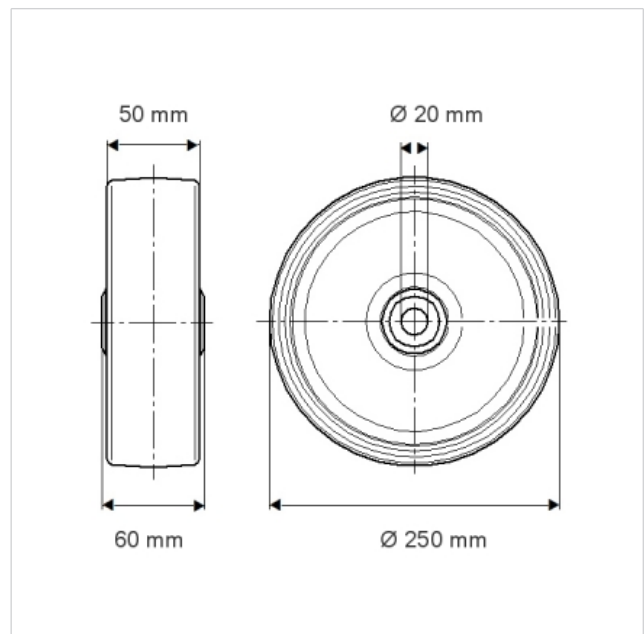



TOP250x50-Ø20

EAN 4031582366266

