

ZS10-R1 Screw Clamp Terminal Blocks Feed-through

With the same profile as the ZS10-ST..., the feed-through ZS10-R1 allows you to fully implement the electrical drawing of your CT or PT circuits,
- Fully compatible with the ZS10-ST... accessories.

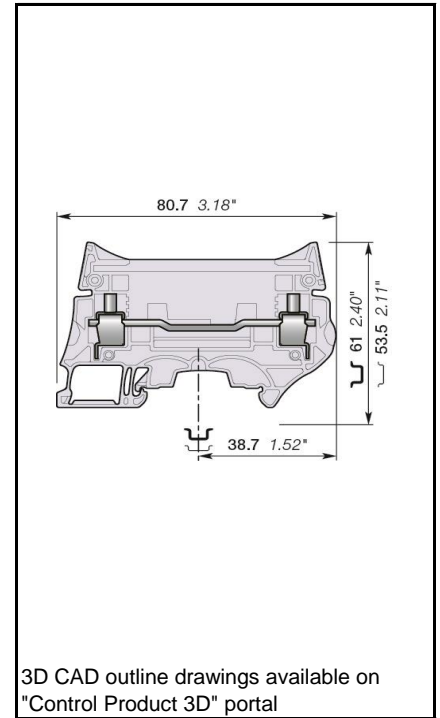

		10 mm²
		6 AWG
8 mm 0,315 in Spacing		

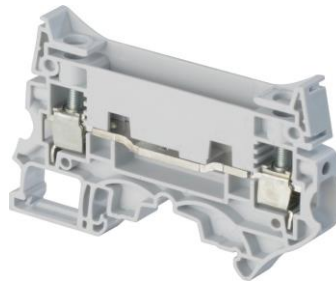





Ordering Details

Color	Type	Order Code	EAN Code	Pack ^(ing)	Weight (1 pce) g
Grey	ZS10-R1	1SNK508011R0000	3472595080113	25	20.90

Declarations and Certificates



		RoHS						
CE	CB	RoHS	USR		Gost R			
		BV						

Declarations and Certificates

	CE	1SND225113C10*
	CB	1SND161092A02*
	RoHS	1SND230516F02*
	USF	1SND161041A02*
	CSA	1SND161070A02*
	GOST R	1SND161005A11*
	BV	1SND161073A02*

General Information

The following information must be strictly adhered to in order to guarantee the terminal block electrical, mechanical and environmental performance.

Protection	IEC 60947-1	IP20		NEMA 1			
Rail	TH35-7.5, TH35-15	TH35-7.5, TH35-15					
Wire stripping length		13 mm	0.512 in				
		Screw clamp		Screw rail contact (Maximum value)		Disconnect device	
Operating tool		Flat screwdriver					
		3.5 mm	0.138 in				
Torque		1,3 N.m	11,5 lb.in				
		± 0,3 N.m	± 2.65 lb.in				

Material Specifications

Insulating material	Polyamide
CTI	600 V
Flammability	UL94 V0
	NF F 16101 I2F2
	Needle flame test: C 60615-11-5 Compliant

Connecting capacity per clamp

		Screw clamp			
1 Rigid - Solid / Stranded conductor	Norme	IEC60947-7-1	UL1059		
	Value	0.5 ... 10 mm ²	24 ... 6 AWG		
1 Flexible conductor	Norme	IEC60947-7-1			
	Value	0.5 ... 10 mm ²			
1 Flexible conductor with non insulated ferrule	Norme	Manufacturer data	Manufacturer data		
	Value	0.5 ... 10 mm ²	24 ... 8 AWG		
1 Flexible conductor with insulated ferrule	Norme	Manufacturer data	Manufacturer data		
	Value	0.5 ... 6 mm ²	24 ... 10 AWG		
Gauge		A5-B5	5.2 mm		
		IEC 60947-1	0.205 in		
Ferrule maximum outer diameter or conductor insulation maximum outer diameter		Manufacturer data	7.5 mm	0.295 in	

The "Connecting capacity with ferrule" data is guaranteed with ABB crimping tool PS-3 (crimping capacity up to 10 mm²).

As part of its on-going product improvement, ABB reserves the right to modify the characteristics or the products described in this document. The information given is not contractual. For further details please contact the ABB company marketing these products in your country.

Multi Connecting capacity per clamp

2 Rigid - Solid / Stranded conductors	Norme	IEC60947-7-1	UL1059	
	Value	0.5 ... 4 mm ²	20 ... 12 AWG	
2 Flexible conductors	Norme	IEC60947-7-1		
	Value	0.5 ... 4 mm ²		
2 Flexible conductors with twin ferrule	Norme	Manufacturer data	Manufacturer data	
	Value	0.5 ... 4 mm ²	20 ... 12 AWG	

Don't mix **solid and flexible** conductors **in the same clamp**

Don't mix **solid or flexible** conductors of different sizes **in the same clamp**

The "Connecting capacity with ferrule" data is guaranteed with ABB crimping tool PS-3 (crimping capacity up to 10 mm²)

Cross section

Rated cross section	IEC60947-7-1	10 mm ²	UL1059	6 AWG
Maximum Cross section	Manufacturer data	10 mm ²	Manufacturer data	6 AWG

Electrical characteristics

Current

Rated current		IEC60947-7-1	57 A
	Field and factory wiring Cat.2	UL 1059	62 A
	Factory wiring Cat.1	UL 1059	62 A
		CSA-C-22.2 n°158	62 A
Maximum Exe current		IEC/EN 60079-7	
Rated short-time withstand current 1 s (I _{cw})		IEC60947-7-1	1200 A
Short-time withstand current	0.5 s	Manufacturer data	
	5 s	Manufacturer data	
	10 s	Manufacturer data	
	30 s	Manufacturer data	
	1 min	Manufacturer data	
Rated short-circuit withstand current		CSA-C-22.2 n°158	
Max. current (45° temperature increase) / Max. cross section (mm ²)		Manufacturer data	10 mm ²
Maximum short circuit current (1s)		Manufacturer data	1200 A

Short Circuit Current Rating (SCCR) SA UL 1059 supplement

SCCR	UL 1059
With the following configurations:	
Suitable conductor wire range	
Maximum voltage	
Fuse class / Max. amp. Rating	J
	T
	RK1
	RK5
	G
	CC

Voltage

Rated voltage	IEC 60947-1	630 V
Rated voltage	UL 1059	300 V
Use Group	UL 1059	B, C
Rated voltage	CSA-C-22.2 n°158	300 V
Rated voltage Ex e	IEC/ EN 60079-7	
Rated impulse withstand voltage	IEC 60947-1	8000 V
Dielectric test voltage	IEC 60947-1	2000 V
Pollution degree	IEC 60947-1	3
Overvoltage category	IEC 60947-1	III

Temperature range

Ambient temperature min/max	Storage	-55 ... +110 °C	-67 ... +230 °F
	Installing	-5 ... +40 °C	-23 ... +104 °F
	Service	-55 ... +110 °C	-67 ... +230 °F

Current Derating curve for continuous service temperature

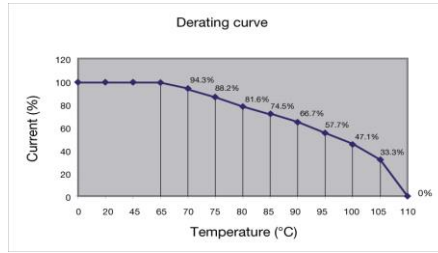

Dissipated power

Maximum dissipated power at rated current	IEC 60947-1	3,3 W
Maximum dissipated power at maximum Exe current	IEC 60079-7	

Rated power dissipation at an ambient temperature of 23 °C - IEC 60947-7-3

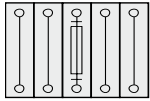
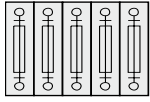
Separate arrangement / Overload and short-circuit protection	 <p>1 fuse and 4 feed-through blocks</p>	
Separate arrangement / Exclusive short-circuit protection		
Compound arrangement / Overload and short-circuit protection	 <p>5 fuse blocks</p>	
Compound arrangement / Exclusive short-circuit protection		

Environmental Characteristics Additional climatic tests

Dry heat	Conditions	IEC 60068-2 2	Compliant
		Temperature	+100 °C
		Duration of test	96 h
Cyclic damp heat	Conditions	IEC 60068-2 30	Compliant
		Temperature	+55 °C
		Relative humidity	
		Number of cycles (1 cycle = 24h)	2
Cold	Conditions	IEC 60068-2 1	Compliant
		Temperature	-40 °C
		Duration of test	96 h
Damp heat steady state	Conditions	IEC 60068-2-78	
		Temperature	
		Relative humidity	
		Duration of test	

Corrosion

Salt mist	Conditions	IEC 60068-2 11	Compliant
		Duration of test	96 h
		Concentration	5 %
SO ₂	Conditions	ISO 6988	Compliant
		Duration of test	48 h
		Concentration	0.2 dm ³
Flowing mixed gas corrosion test	Conditions	IEC 60068-2 60	
		Number of the test method	
		Duration of test	

As part of its on-going product improvement, ABB reserves the right to modify the characteristics or the products described in this document. The information given is not contractual. For further details please contact the ABB company marketing these products in your country.

Vibrations and shocks

Sinusoidal vibrations		IEC 60068-2-6
Conditions	Frequency range	10 ... 55 Hz
	Number of cycles	10
	Acceleration	10 m/s ²
Functional random vibrations		IEC 61373
Category 1 Class B 3 axes	Conditions	Duration of test
		Frequency range
		Acceleration
Long life testing at increased random vibrations		IEC 61373
Category 1 Class B 3 axes	Conditions	Duration of test
		Frequency range
		Acceleration
Shock		IEC 61373
Category 1 Class B 3 axes	Conditions	Duration of test
		Acceleration

ZS10-R1 Terminal Block Accessories Compatibility

Some accessories may modify the terminal block's rating. See complete information in the accessories catalog page.

Description	Type	Order Code	Pack ^(ing) pieces	Weight g (1 pce)
1 End Stops	BAM3	1SNK900001R0000	50	13.80
	BAZ1	1SNK900002R0000	20	5.30
	BAZH1	1SNK900102R0000	20	23.90
2 End Sections	ES10-ST	1SNK508910R0000	20	3.52
3 Jumper Bars	JB8-2-R1	1SNK908902R0000	10	7.60
	JB8-3-R1	1SNK908903R0000	10	11.60
	JB8-4-R1	1SNK908904R0000	10	15.50
	JB8-5-R1	1SNK908905R0000	10	19.40
	JB8-10-R1	1SNK908910R0000	10	39.00
4 Lateral Jumper Bars	PC8-2	1SNA116538R1700	10	3.00
	PC8-3	1SNA116539R1000	10	4.00
	PC8-4	1SNA116540R2500	10	6.00
	PC8-10	1SNA163313R2400	10	14.00
	PC8-R1	1SNA400711R0600	10	6.60
	PC8-R2	1SNA400712R0700	10	7.84
	PC8-R3	1SNA400713R0000	10	9.00
5 Test Sockets	PC8-R4	1SNA400724R0300	10	4.50
	AJS9	1SNA179726R0200	25	3.60
	AJS9-1	1SNA206680R1500	25	3.60
	AJS9-2	1SNA206681R0200	25	3.60
	AJS9-3	1SNA206682R0300	25	3.60
	AJS9-4	1SNA206683R0400	25	3.60
	AJS9-5	1SNA206720R1400	25	3.60
	AL4-M3	1SNA206721R0100	50	1.10
AJS10	1SNA206759R0000		5.00	
6 Protecting Cover Kits	KCO	1SNK900624R0000	1	47.80
7 Protecting Covers	CO	1SNK900604R0000	1	300.00
8 Short Circuit Plugs	BP8.A4	1SNA173888R2000	10	
9 Short Circuit Bridges	SC-JB8-2	1SNK900652R0000	25	2.00
	SC-JB8-3	1SNK900653R0000	25	3.40
	SC-JB8-4	1SNK900654R0000	25	4.70
	SC-JB8-5	1SNK900655R0000	25	4.70
10 Terminal Block Markers	MC812	1SNK160000R0000	22	10.00
	MC812PA	1SNK160011R0000	1	14.00
	UMH	1SNK900611R0000	10	0.20
	SAT8	1SNK900616R0000	5	6.00
	ZS10-R1	1SNK508011R0000	25	20.90
11 Screw Clamp Terminal Blocks				

As part of its on-going product improvement, ABB reserves the right to modify the characteristics or the products described in this document. The information given is not contractual. For further details please contact the ABB company marketing these products in your country.

Contact us

ABB France
Low Voltage Products Division
Export Department
10, rue Ampère Z.I. - B.P. 114
F-69685 Chassieu cedex / France
Tel. +33 (0)4 7222 1722
Fax +33 (0)4 7222 1935

Note

We reserve the right to make technical changes or modify the contents of this document without prior notice. With regard to purchase orders, the agreed particulars shall prevail. ABB does not accept any responsibility whatsoever for potential errors or possible lack of information in this document.

We reserve all rights in this document and in the subject matter and illustrations contained therein. Any reproduction, disclosure to third parties or utilization of its contents – in whole or in parts – is forbidden without prior written consent of ABB.

Copyright© 2011 ABB
All rights reserved

1SNK161059D0201 - PDF