

Accessories

E11817

Fixing strap for clean-line cylinders

Ø 16...20 mm

Piston diameter

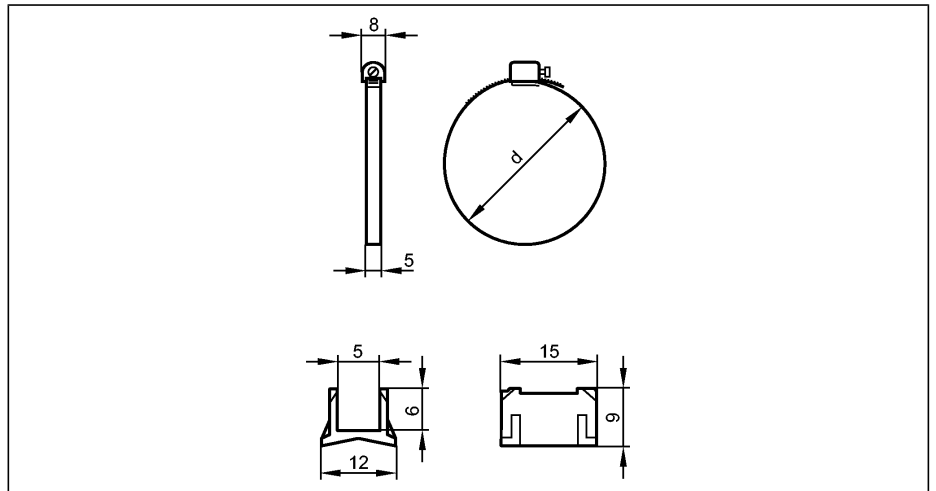

Made in Germany

Design	for types MKT
Piston diameter [mm]	16...20
Clamping range d [mm]	18...29
Housing materials	adapter: PA (polyamide); Fixing strap: stainless steel (303S22)
Weight [kg]	0.006
Accessories (included)	adapter for types MKT