

## Description

Single pole thermal circuit breaker with press-to-reset, tease-free, trip-free, snap action mechanism. Type 2-5000 is available with optional manual release (-H), type 2-5700 can be supplied as a push-push switch/circuit breaker (R-type TO CBE to EN 60934 in press-to-reset configuration; M-type when fitted with manual release -H; S-type with push-push operation). Fitted with flange or threadneck for panel mounting. Options include an additional unprotected circuit tap (-A3). Approved to CBE standard EN 60934 (IEC 60934).

## Typical applications

Motors, transformers, solenoids, battery chargers, power supplies, appliances, machinery, extra low voltage systems.

## Ordering information

Type No.	
2-5000	flange mounting
2-5700	threadneck panel mounting (hardware bulk shipped)
<b>Threadneck design – type 2-5700 only</b>	
iG1	moulded threadneck 3/8"-27UNS-2A
iG2	moulded threadneck M12x1
<b>Terminal design</b>	
P10	blade terminals 6.3-0.8 mm (QC .250)
K10	screw terminals M4x6
<b>Shunt terminal (optional) -P10 only</b>	
A3	shunt terminal (up to $I_N$ 2.5 A/6 A max. load)
<b>Manual release (optional)</b>	
H	manual release facility (type 2-5000 only)
DD	push to release/push to reset (type 2-5700 only)
<b>Current ratings</b>	
0.05...25 A	
2-5700 -iG1 - P10 - ... - DD - 8 A ordering example	

The exact part number required can be built up from the table of choices shown above. Ordering references for optional features should be omitted if not required.

## Standard current ratings and typical internal resistance values

Current rating (A)	Internal resistance ( $\Omega$ )	Current rating (A)	Internal resistance ( $\Omega$ )
0.05	280	3	0.1
0.08	100	3.5	0.06
0.1	110	4	0.06
0.2	29	4.5	0.05
0.3	14	5	0.05
0.4	7	6	0.02
0.5	4.9	7	0.02
0.6	3.4	8	0.02
0.7	2.5	10	< 0.02
0.8	1.8	12	< 0.02
1	1.2	13	< 0.02
1.2	0.8	15	< 0.02
1.5	0.6	16	< 0.02
1.8	0.4	20	< 0.02
2	0.3	22	< 0.02
2.5	0.2	25	< 0.02

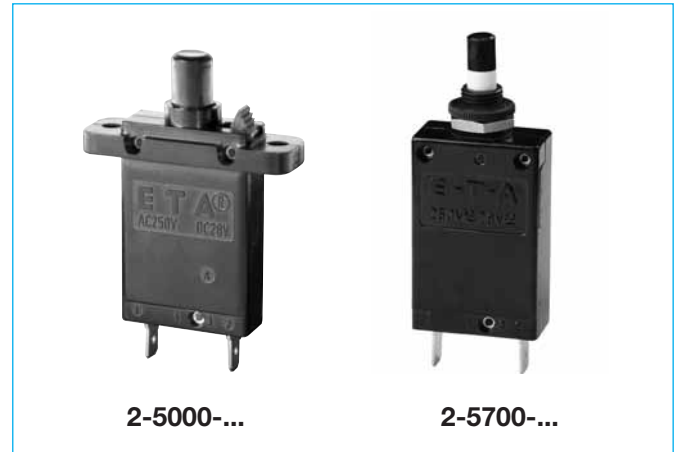

## Technical data

For further details please see chapter: Technical Information

Voltage rating	AC 250 V; DC 28 V (UL: AC 250 V; DC 50 V)	
Current rating range	0.05...25 A	
Typical life	AC 250 V / DC 28 V: 0.05...16 A 5,000 operations at $2 \times I_N$ , inductive 17...25 A 5,000 operations at $2 \times I_N$ , resistive	
Ambient temperature	-20...+60 °C (-4...+140 °F)	
Insulation co-ordination (IEC 60664 and 60664 A)	rated impulse withstand voltage 2.5 kV reinforced insulation in operating area	pollution degree 2
Dielectric strength (IEC 60664 and 60664A) operating area	test voltage AC 3,000 V	
Insulation resistance	> 100 M $\Omega$ (DC 500 V)	
Interrupting capacity $I_{cn}$	0.05...2.5 A 3...5 A 6...12 A  13...25 A	$8 \times I_N$ $20 \times I_N$ 200 A (higher interrupting capacity available to special order) 400 A
Interrupting capacity (UL 1077)	$I_N$ 0.05...20 A 0.05...25 A (higher values upon request)	$U_N$ AC 250 V 2,000 A DC 50 V 2,000 A
Degree of protection (IEC 60529/DIN 40050)	operating area IP40 terminal area IP00	
Vibration	8 g (57-500 Hz) $\pm$ 0.61 mm (10-57 Hz), to IEC 60068-2-6, test Fc, 10 frequency cycles/axis	
Shock	25 g (11 ms) to IEC 60068-2-27, test Ea	
Corrosion	96 hours at 5 % salt mist, to IEC 60068-2-11, test Ka	
Humidity	240 hours at 95 % RH to IEC 60068-2-78, test Cab	
Mass	approx. 29 g	

## Approvals

Authority	Voltage ratings	Current ratings
VDE (EN 60934)	AC 250 V; DC 28 V	0.05...25 A
CSA/ UL	AC 250 V; DC 50 V	0.05...20 A
CCC	AC 250 V	0.05...25 A
SEV	AC 250 V; DC 28 V	0.05...25 A



## Internal connection diagrams

**0.05 ... 2.5 A**  
(with or without shunt terminal)

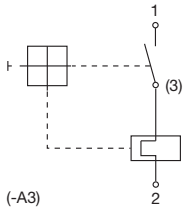

**3 ... 25 A**  
(without shunt terminal)

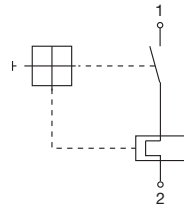

## Typical time/current characteristics at +23 °C/+73.4 °F

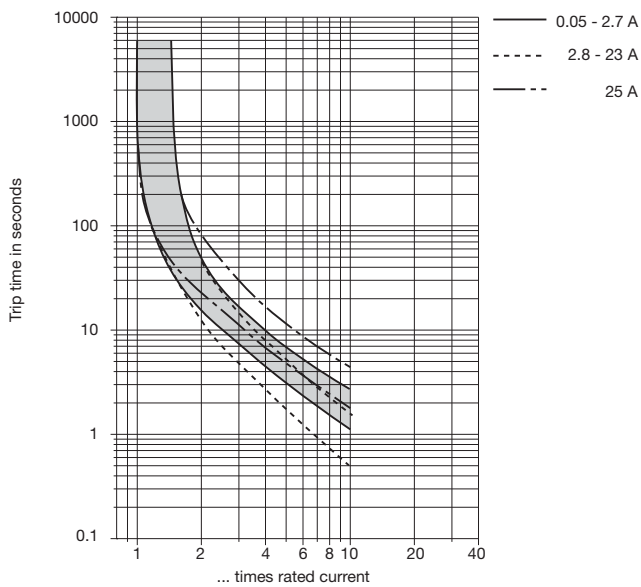

The time/current characteristic curve depends on the ambient temperature prevailing. In order to eliminate nuisance tripping, please multiply the circuit breaker current ratings by the derating factor shown below. See also section 9 – Technical information.

Ambient temperature °F	-4	+14	+32	+73.4	+104	+122	+140
°C	-20	-10	0	+23	+40	+50	+60
Derating factor	0.76	0.84	0.92	1	1.08	1.16	1.24

## Accessories for types 2-5000 and 2-5700 with screw terminals -K10

**Bus bar  
Y 303 563 01**

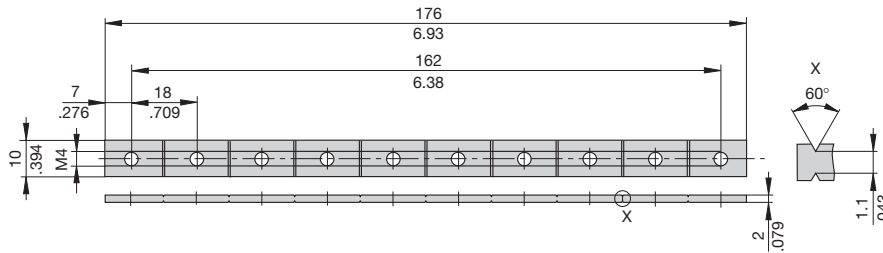

## Accessories for type 2-5000-...

**Water splash cover, transparent  
for push button (IP64)  
Y 300 728 01**

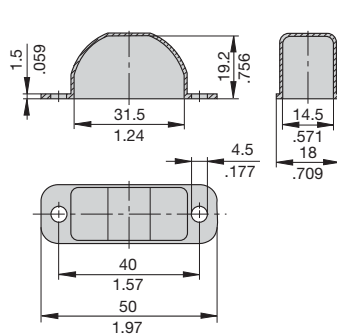

**Fixing plate  
Y 301 056 02**

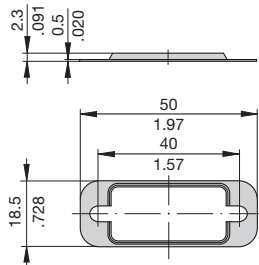

**Rear terminal shroud, transparent (IP64)  
Y 300 476 01**

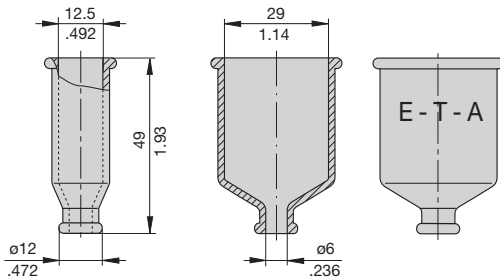

## Accessories for type 2-5700-...

**With 3/8" threadneck (-iG1)**

**Water splash cover, transparent Y 300 538 01 and  
knurled nut Y 300 628 01  
X 200 799 01 (IP64)**

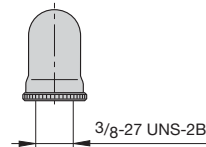

**Water splash cover,  
transparent with  
special knurled nut  
X 200 798 02 (IP64)**

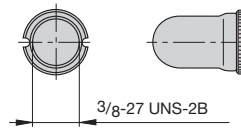

**Hex nut with splash  
cover black without O ring  
X 210 739 01 (IP64)  
transparent splash cover  
X 201 296 03 (IP64)**

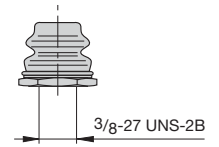

**Separate hardware  
Hex nut  
Y 300 192 01**

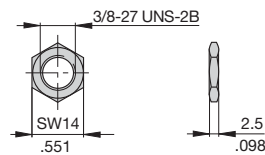

**Knurled nut  
Y 307 117 02**

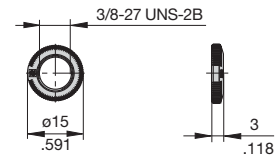

**With M12 threadneck (-iG2)**

**Hex nut with splash cover, black  
X 201 296 01 without O ring (IP64)  
X 200 801 03 with O ring  
(IP66 and IP67)**

**Hex nut with splash cover,  
transparent  
X 200 801 08 with O ring  
(IP66 and IP67)**



**Water splash cover,  
transparent with knurled nut  
and O ring  
X 210 663 01 (IP64)**

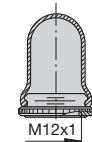

**Hex nut  
Y 300 116 02**

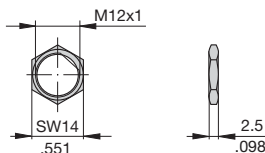

**Knurled nut  
Y 302 065 01**

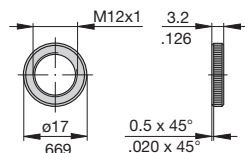

This is a metric design and millimeter dimensions take precedence ( $\frac{\text{mm}}{\text{inch}}$ )

All dimensions without tolerances are for reference only. In the interest of improved design, performance and cost effectiveness the right to make changes in these specifications without notice is reserved. Product markings may not be exactly as the ordering codes. Errors and omissions excepted.