

## Datasheet

### Rack mount enclosure, 1U 245mm Black

RS Stock number 665-7700

#### Product Information PF 19" Series

---

**The PF-19 Enclosure Series** is a high quality, heavy duty electronic enclosure for multiple users. Whether you have industrial requirements or are a home hobbyist, the PF-19 will work for you.

Combining a well engineered design, top grade materials and precision workmanship, users will find the PF-19 easy to work with and flexible in its range of applications.

The sturdy construction and tough powder coat finish ensures the PF-19 provides a strong and attractive finished product, which looks good wherever it is used.

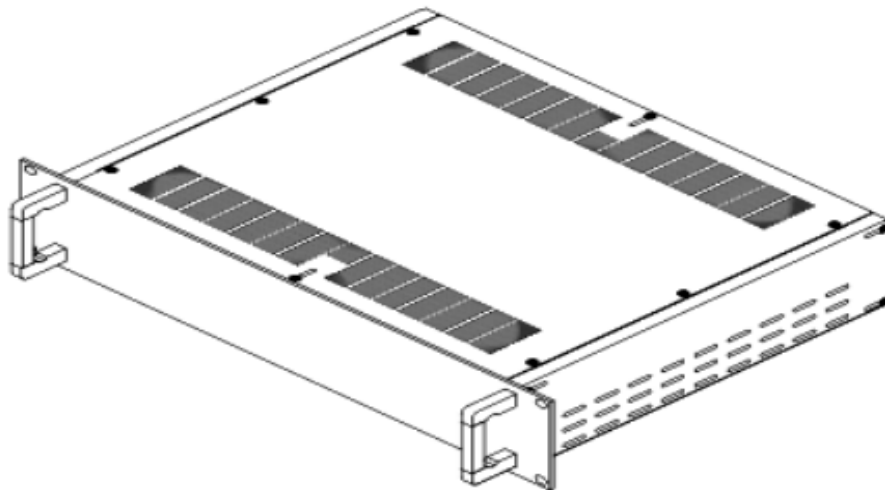

#### Features :

- Complies with IEC 297, EIA RS-310 C1977, DIN41494; allows complete compatibility with all 19" standard equipment.
- Careful design allows for easy modification to the customer's requisites.
- Wide range of applications ; the PF-19 system consists of 6 sizes from 1U to 6U and 5 different depths.
- Precise and high quality manufacturing standard enables fast and easy assembly.
- Packed flat for convenient shipment and storage.

#### Materials/Finish :

High grade cold rolled steel.  
Aluminum on Front and Rear panel  
Powder coat finish preceded by 5 stage iron phosphate pretreatment.  
Conforms to ASTM D610-01 (Creepage test)  
Conforms to ASTM B117 (500 hours salt spray test)  
Standard color is low gloss black. Special colors upon request.

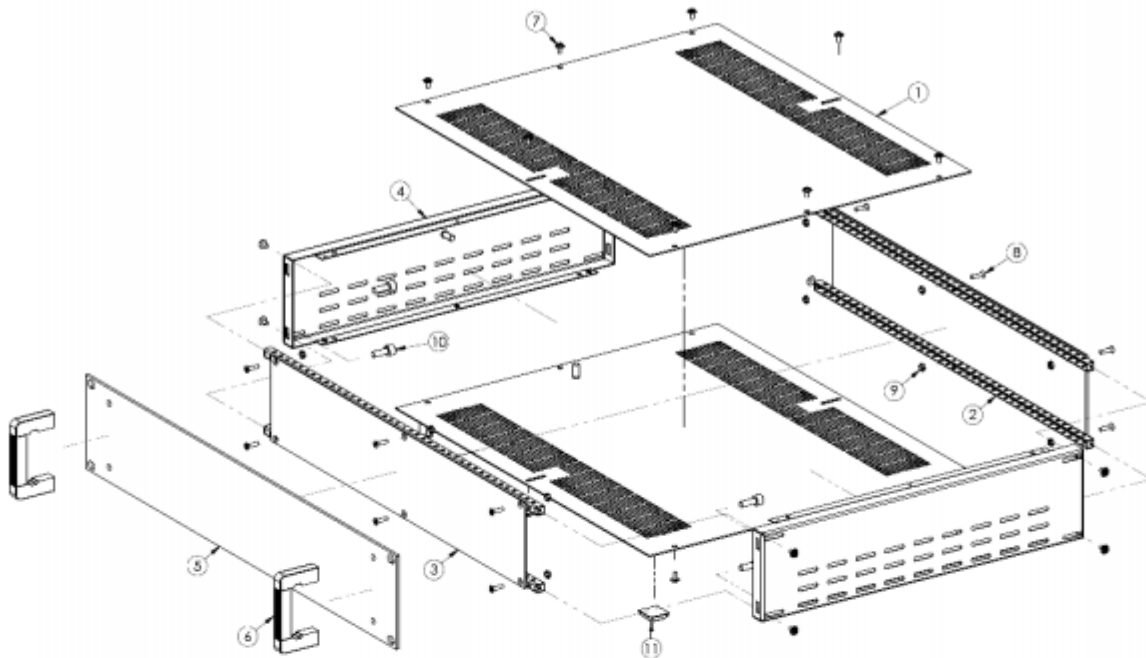

PF 19 inches Part List :

Item	Material	Contents of Kit					
		1U	2U	3U	4U	5U	6U
1. Top / Base Panel	Mild steel 1.2 MM	2	2	2	2	2	2
2. General Purpose Bar (90mm/other models)	Zinc plate steel 0.9 MM	4/8	8	8	8	8	8
3. Inside Front/ Rear Panel	AL (0.9/1.2 MM)	2 (0.9)	2 (0.9)	2(1.2)	2(1.2)	2(1.2)	2(1.2)
4. Side Panel	Mild Steel 0.9 MM	2	2	2	2	2	2
5. Front Panel	AL 3.0 MM	1	1	1	1	1	1
6. Handle	AL extruded	2	2	2	2	2	2
7. Umbrella Phillips screw	M3x6	28	28, 32	16	16	16	16
8. Umbrella Phillips screw	M4x8	-	-	16	16	16	16
9. Flat Head screw	M3x12 with nut	12	12	-	-	-	-
10. Flat Head screw	M3x15	-	-	12	12	12	12
11. Round Head screw	M5x15 with nut	-	4	4	4	4	4
12. Hex screw	M5x15 with nut	4	-	-	-	-	-

**Note :** Torque 7 in lbs for screw M3  
Torque 10 in lbs for screw M4

## Available Dimensions :

There are 24 different sizes and configurations which are available in :

- Height : 1.5U to 6U (B)
- Width : 482 (A)
- Depth : 90, 245, 335, 425 and 465 (D)

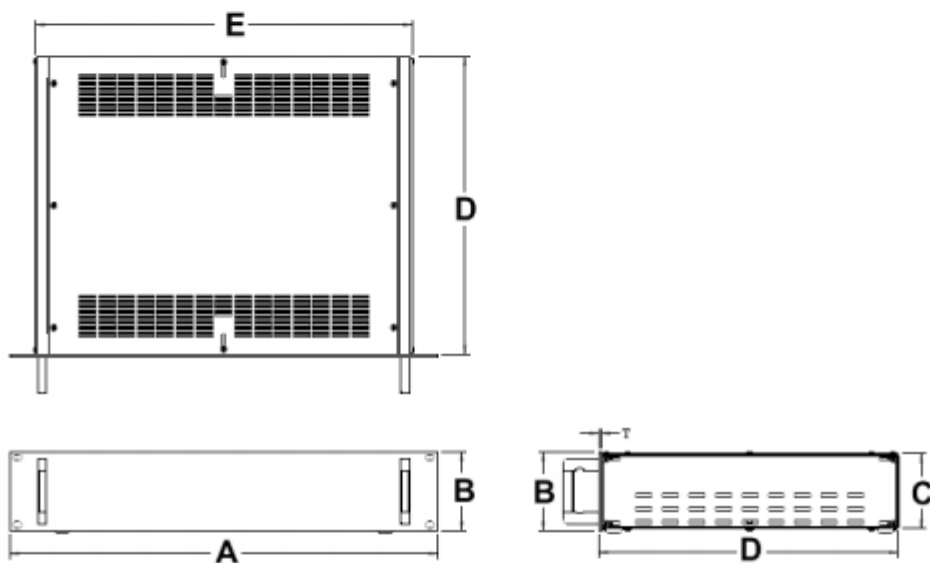

RS Stock No.	Model	Front Panel (A x B)	Handle Height	Cabinet (E x D x C)
665-7706	1U-D0	483 x 44	25	425x90x39 mm
665-7700	1U-D1	483 x 44	25	425x245x39 mm
665-7719	2U-D1	483 x 88	60	425x245x83 mm
665-7712	2U-D2	483 x 88	60	425x335x83 mm
665-7716	3U-D2	483 x 133	90	425x335x128 mm
665-7725	3U-D3	483 x 133	90	425x425x128 mm
665-7728	4U-D2	483 x 177	130	425x335x172 mm
665-7722	4U-D3	483 x 177	130	425x425x172 mm
665-7731	5U-D3	483 x 222	130	425x425x217 mm
665-7734	6U-D3	483 x 266	130	425x425x261 mm
665-7738	6U-D4	483 x 266	130	425x465x261 mm