

Product Datasheet

Screw Disconnect Terminal Blocks 2.5sq.mm

Screw Clamp Disconnect Terminal Blocks, 12A, 600V, 22-12 AWG, 0.5-2.5 sq.mm

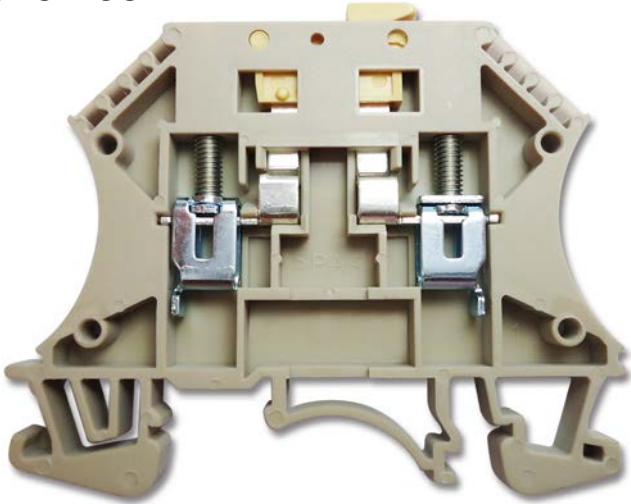



878-7584

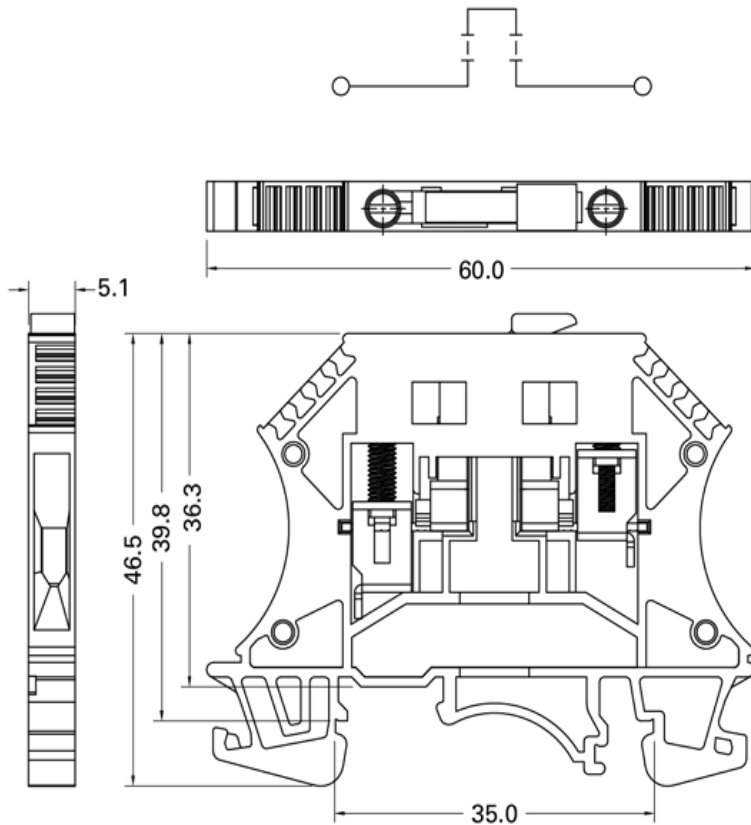

Dimensions in mm

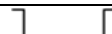
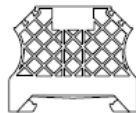
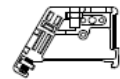

Product Specifications:

Specifications	2.5mm ²
Technical Date	Rated voltage / Rated current / Wire size
UL	600V / 12A / AWG 22-12
CSA	600V / 12A / AWG 22-12
IEC	500V / 15A / 0.5-2.5mm ²
Insulating impulse voltage withstand/pollution degree	6KV / 3
Torque (in -lbs)	4.5
Clamping Screw (M)	M3
Insulation stripping length (mm)	10~12 mm
Net weight per piece	8.9g
Material / Available Color (Standard Color: Beige)	 Red Orange Beige Blue Grey White Black
Rail Dimensions	T / W / H (mm)
For TS35x7.5 	5.1 x 60 x 47.5
For TS35x15 	5.1 x 60 x 55
Accessories	Cat. No.
End Bracket 	8787553
	8787556
End plate 	8787540
Marking Tags 	8787590