

**PLEASE CHECK WWW.MOLEX.COM FOR LATEST PART INFORMATION**

**Part Number:** [504186-2400](#)  
**Status:** **Active**  
**Overview:** Micro-Lock™ Connectors  
**Description:** Micro-Lock™ 1.25mm Pitch Dual-Row Crimp Housing, White, 24 Circuits

**Documents:**

<a href="#">3D Model</a>	<a href="#">Application Specification AS-504186-002 (PDF)</a>
<a href="#">Drawing (PDF)</a>	<a href="#">Packaging Specification SPK-504186-001 (PDF)</a>
<a href="#">Product Specification PS-504186-001 (PDF)</a>	<a href="#">RoHS Certificate of Compliance (PDF)</a>
<a href="#">Application Specification AS-504186-001 (PDF)</a>	

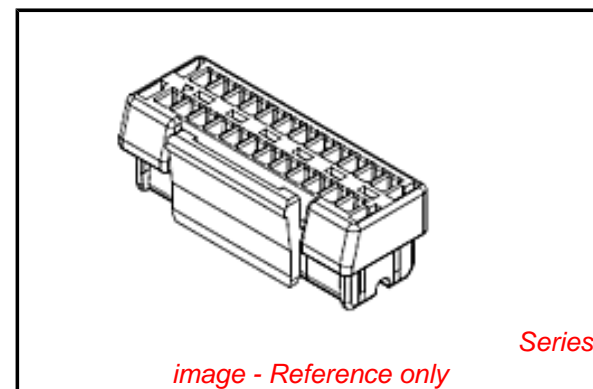

**General**

Product Family	Crimp Housings
Series	504186
Application	Wire-to-Board
Overview	<u>Micro-Lock™ Connectors</u>
Product Name	Micro-Lock™
UPC	887191161716

**Physical**

Circuits (maximum)	24
Color - Resin	White
Gender	Female
Glow-Wire Compliant	No
Lock to Mating Part	Yes
Material - Resin	Polyester
Net Weight	358.045/mg
Number of Rows	2
Packaging Type	Tray
Panel Mount	No
Pitch - Mating Interface	1.25mm
Pitch - Termination Interface	1.25mm
Polarized to Mating Part	Yes
Temperature Range - Operating	-25°C to +85°C

**Electrical**

Current - Maximum per Contact	1.5A
-------------------------------	------

**Material Info**

**Reference - Drawing Numbers**

Application Specification	AS-504186-001, AS-504186-002
Packaging Specification	SPK-504186-001
Product Specification	PS-504186-001, RPS-504186-001, RPS-504186-002
Sales Drawing	SD-504186-001

**EU RoHS**

**ELV and RoHS Compliant**  
**REACH SVHC**  
**Contains SVHC: No**  
**Low-Halogen Status**  
**Not Low-Halogen**

**China RoHS**



**Need more information on product environmental compliance?**

Email [productcompliance@molex.com](mailto:productcompliance@molex.com)  
 For a multiple part number RoHS Certificate of Compliance, [click here](#)

Please visit the [Contact Us](#) section for any non-product compliance questions.

**Search Parts in this Series**

[504186Series](#)

**Mates With**

Micro-Lock™ 1.25mm Pitch Header [504187](#), [504189](#)

**Use With**

Micro-Lock™ Wire-to-Board Crimp Terminal [504185-1000](#)