

# NEW

## Multifunctional three-phase monitoring relays CM-MPN.52, CM-MPN.62 and CM-MPN.72 Data sheet

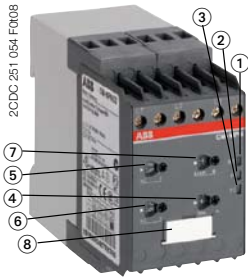

CM-MPN.52

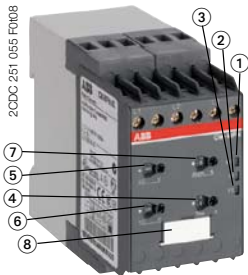

CM-MPN.62

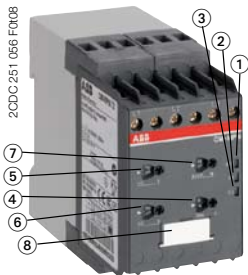

CM-MPN.72

- ① R/T: yellow LED - relay status, timing
- ② F1: red LED - fault message
- ③ F2: red LED - fault message
- ④ Adjustment of the tripping delay  $t_v$
- ⑤ Adjustment of the threshold value for overvoltage
- ⑥ Adjustment of the threshold value for undervoltage
- ⑦ Adjustment of the threshold value for phase unbalance
- ⑧ Function selection (see DIP switch functions) / Marker label

### Features

- Monitoring of three-phase mains for phase sequence (can be switched off), phase failure, over- and undervoltage as well as phase unbalance
- Automatic phase sequence correction configurable
- Threshold values for phase unbalance, over- and undervoltage are adjustable as absolute values
- Tripping delay can be adjusted or switched off by means of a logarithmic scale
- ON-delayed or OFF-delayed tripping delay selectable
- Powered by the measuring circuit
- True RMS measuring principle
- 1x2 or 2x1 c/o (SPDT) contact configurable
- 3 LEDs for status indication

### Approvals

	UL 508, CAN/CSA C22.2 No.14	(only CM-MPN.52 und CM-MPN.62)
	GL	
	GOST	
	CB scheme	
	CCC	

### Marks

- CE
- C-Tick

### Order data

Type	Rated control supply voltage = measuring voltage	Order code
CM-MPN.52	3x350-580 V AC	1SVR 650 487 R8300
CM-MPN.62	3x450-720 V AC	1SVR 650 488 R8300
CM-MPN.72	3x530-820 V AC	1SVR 650 489 R8300

### Order data - Accessories

Type	Description	Order code
ADP.01	Adapter for screw mounting	1SVR 430 029 R0100
MAR.02	Marker label for devices with DIP switch	1SVR 430 043 R0000
COV.02	Sealable transparent cover	1SVR 440 005 R0100

### Application

The CM-MPN.x2 are multifunctional monitoring relays for three-phase mains. They monitor the phase parameters phase sequence, phase failure, over- and undervoltage and phase unbalance. The threshold values for over- and undervoltage and phase unbalance are adjustable.

**NEW**

# Multifunctional three-phase monitoring relays

## CM-MPN.52, CM-MPN.62 and CM-MPN.72

### Data sheet

#### Operating mode

Configuration of the devices is made by means of setting elements accessible on the front of the unit and signalling is made by means of front-face LEDs.

#### Adjustment potentiometer

##### Threshold values









By means of three separate potentiometers with direct reading scales, the threshold values for over- and undervoltage as well as for phase unbalance can be adjusted within the measuring range.

	Measuring range for overvoltage	Measuring range for undervoltage	Measuring range for phase unbalance
<b>CM-MPN.52</b>	3x480-580 V AC	3x350-460 V AC	2-25 % of average of phase voltages
<b>CM-MPN.62</b>	3x600-720 V AC	3x450-570 V AC	
<b>CM-MPN.72</b>	3x690-820 V AC	3x530-660 V AC	

#### Tripping delay $t_v$



The tripping delay  $t_v$  can be adjusted within a range of 0.1-30 s by means of a potentiometer with logarithmic scale. By turning to the left stop, the tripping delay can be switched off.

#### DIP switches



Position	4	3	2	1
ON †				
OFF				

2CDD 232 041 F0008

#### DIP switch 1 = Timing function

ON = ON-delayed 	OFF = OFF-delayed 
In case of a fault, the de-energizing of the output relays and the respective fault message are suppressed for the adjusted tripping delay $t_v$ .	In case of a fault, the output relays de-energize instantaneously and a fault message is displayed and stored for the length of the adjusted tripping delay $t_v$ . Thereby, also momentary undervoltage conditions are recognized.

#### DIP switch 2 = Phase sequence monitoring





ON = Phase sequence monitoring deactivated 	OFF = Phase sequence monitoring activated 
Phase sequence errors will not be recognized.	The output relays de-energize as soon as a phase sequence error occurs. The output relays re-energize automatically as soon as the phase sequence is correct again.



**NEW**

# Multifunctional three-phase monitoring relays











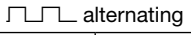

## CM-MPN.52, CM-MPN.62 and CM-MPN.72

### Data sheet

DIP switch 3 = Operating principle of the output relays	
ON = 2x1 c/o (SPDT) contact 	OFF = 1x2 c/o (SPDT) contacts 
<p>Depending on the configuration of automatic phase sequence correction and on the fault type, the output relays R1 (15-16/18) and R2 (25-26/28) react differently, if operating principle 2x1 c/o (SPDT) contact is selected.</p> <p><u>Auto. phase sequence correction deactivated </u>:</p> <ul style="list-style-type: none"> <li>■ Overvoltage: only 1st c/o (SPDT) contact R1 (15-16/18) switches</li> <li>■ Undervoltage: only 2nd c/o (SPDT) contact R2 (25-26/28) switches</li> <li>■ Phase unbalance, phase sequence, phase failure, interrupted neutral: both output relays R1 (15-16/18) and R2 (25-26/28) react synchronously</li> </ul> <p><u>Auto. phase sequence correction activated </u>:</p> <ul style="list-style-type: none"> <li>■ Overvoltage, undervoltage, phase unbalance, phase failure, interrupted neutral: only 1st c/o (SPDT) contact R1 (15-16/18) switches</li> <li>■ Phase sequence: only 2nd c/o (SPDT) contact R2 (25-26/28) switches</li> </ul> <p>Operating principle 2x1 c/o (SPDT) contact is mandatory if automatic phase sequence correction is activated.</p>	<p>If operating principle 1x2 c/o (SPDT) contacts is selected, both output relays R1 (15-16/18) and R2 (25-26/28) react synchronously, independent of the fault type.</p>

DIP switch 4 = Automatic phase sequence correction	
ON = Phase sequence correction activated 	OFF = Phase sequence correction deactivated 
<p>In conjunction with a reversing contactor combination, it is ensured that the correct phase sequence is applied to the input terminals of the load.</p>	<p>No automatic phase sequence correction in case of phase sequence error.</p>

### LEDs

Function	R/T: yellow LED	F1: red LED	F2: red LED
Control supply voltage applied, output relay energized		-	-
Tripping delay $t_v$ active		-	-
Phase failure	-		
Phase sequence	-	 alternating	
Overvoltage	-		-
Undervoltage	-	-	
Phase unbalance	-		
Adjustment error <sup>1)</sup>			

<sup>1)</sup> Possible misadjustments of the front-face operating controls:

Overlapping of the threshold values: An overlapping of the threshold values is given, if the threshold value for overvoltage is set to a smaller value than the threshold value for undervoltage.

DIP switch 3 = OFF and DIP switch 4 = ON: Automatic phase sequence correction is activated and selected operating mode is 1x2 c/o (SPDT) contacts

DIP switch 2 and 4 = ON: Phase sequence detection is deactivated and the automatic phase sequence correction is activated

**NEW**

# Multifunctional three-phase monitoring relays

## CM-MPN.52, CM-MPN.62 and CM-MPN.72

### Data sheet

#### Function descriptions/diagrams

##### Function diagram legend

- Control supply voltage not applied / Output contact open / LED off
- Control supply voltage applied / Output contact closed / LED glowing

#### Phase sequence and phase failure monitoring

Applying control supply voltage begins the fixed start-up delay  $t_s$ . When  $t_s$  is complete and all phases are present with correct voltage, the output relays energize and the yellow LED R/T glows.

##### Phase sequence monitoring

If phase sequence monitoring is activated, the output relays de-energize as soon as a phase sequence error occurs. The fault is displayed by alternated flashing of the LEDs F1 and F2. The output relays re-energize automatically as soon as the phase sequence is correct again.

##### Phase failure monitoring

The output relays de-energize instantaneous if a phase failure occurs. The fault is indicated by lightning of LED F1 and flashing of LED F2. The output relays re-energize automatically as soon as the voltage returns to the tolerance range.

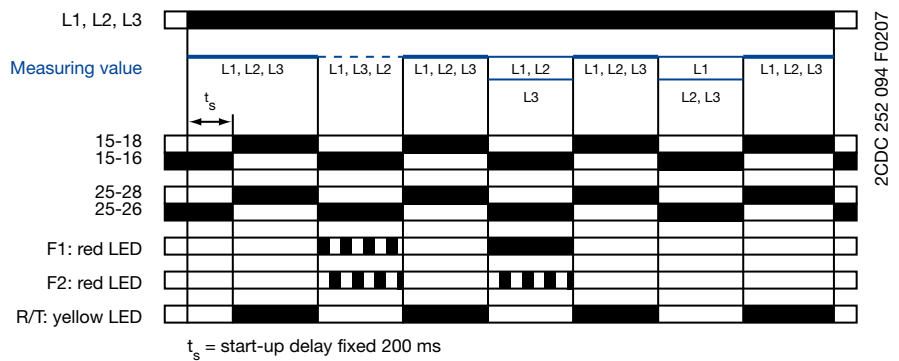

**NEW**

# Multifunctional three-phase monitoring relays

## CM-MPN.52, CM-MPN.62 and CM-MPN.72

### Data sheet

#### Over- and undervoltage monitoring 1x2 c/o (SPDT) contacts 1x2 c/o

Applying control supply voltage begins the fixed start-up delay  $t_s$ . When  $t_s$  is complete and all phases are present with correct voltage and with correct phase sequence, the output relays energize and the yellow LED R/T glows.

#### Type of tripping delay = ON-delay ☒

If the voltage to be monitored exceeds or falls below the set threshold value, the output relays de-energize after the set tripping delay  $t_v$  is complete. The LED R/T flashes during timing and turns off as soon as the output relays de-energize.

The output relays re-energize automatically as soon as the voltage returns to the tolerance range, taking into account a fixed hysteresis of 5 %. The LED R/T glows.

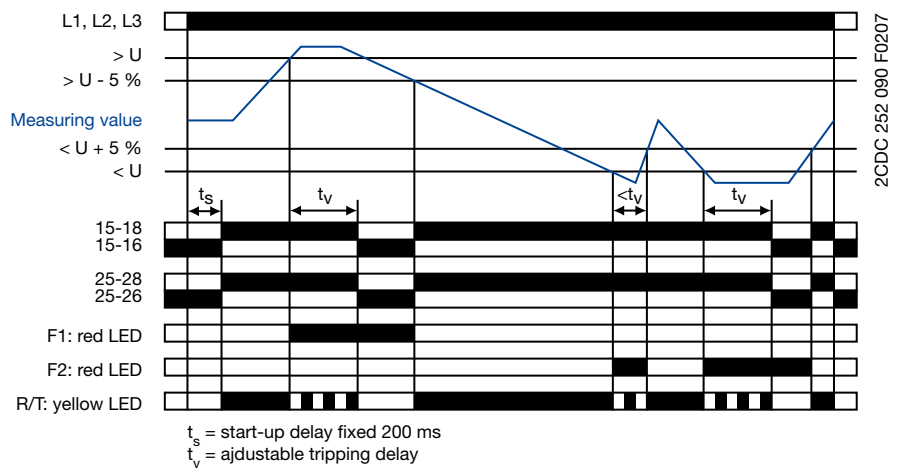

#### Type of tripping delay = OFF-delay ■

If the voltage to be monitored exceeds or falls below the set threshold value, the output relays de-energize instantaneously and the LED R/T turns off.

As soon as the voltage returns to the tolerance range, taking into account a fixed hysteresis of 5 %, the output relays re-energize automatically after the set tripping delay  $t_v$  is complete. The LED R/T flashes during timing and turns steady when timing is complete.

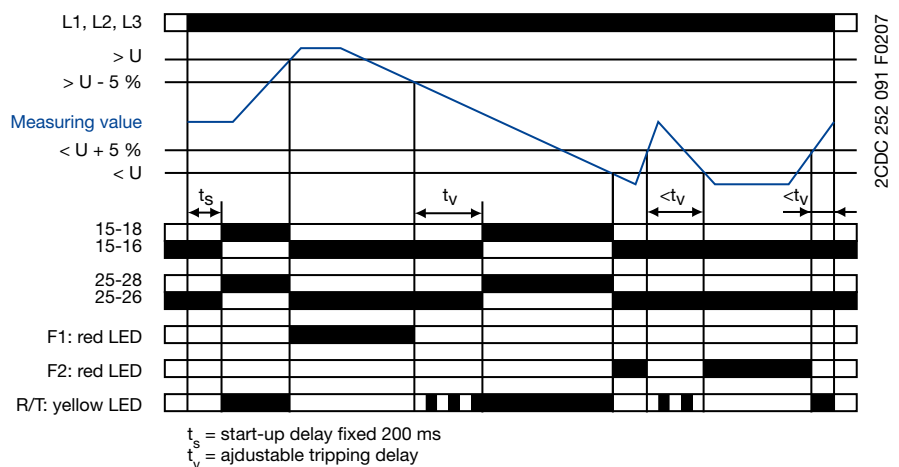

**NEW**

# Multifunctional three-phase monitoring relays

## CM-MPN.52, CM-MPN.62 and CM-MPN.72

### Data sheet

Over- and undervoltage monitoring 2x1 c/o (SPDT) contact 2x1 c/o

Applying control supply voltage begins the fixed start-up delay  $t_s$ . When  $t_s$  is complete and all phases are present with correct voltage and with correct phase sequence, the output relays energize. The yellow LED R/T glows as long as at least one output relay is energized.

#### Type of tripping delay = ON-delay ☒

If the voltage to be monitored exceeds or falls below the set threshold value, output relay R1 (overvoltage) or output relay R2 (undervoltage) de-energizes after the set tripping delay  $t_v$  is complete. The LED R/T flashes during timing.

The corresponding output relay re-energizes automatically as soon as the voltage returns to the tolerance range, taking into account a fixed hysteresis of 5 %.

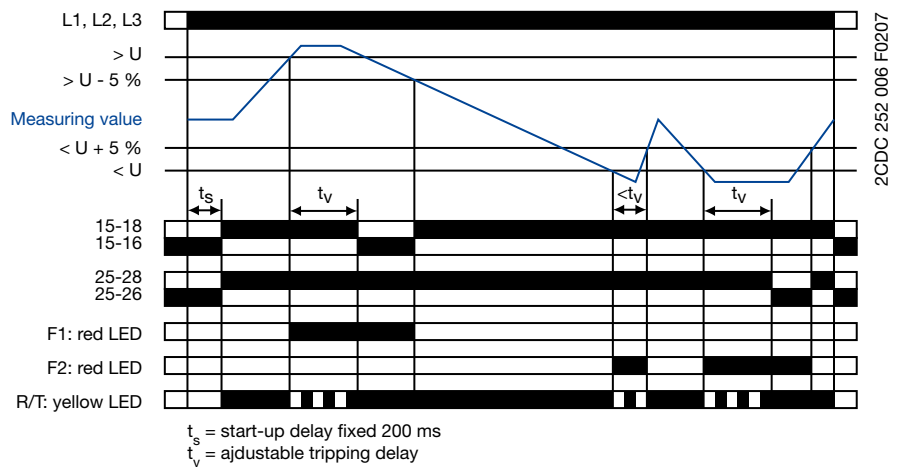

#### Type of tripping delay = OFF-delay ■

If the voltage to be monitored exceeds or falls below the set threshold value, output relay R1 (overvoltage) or output relay R2 (undervoltage) de-energizes instantaneously.

As soon as the voltage returns to the tolerance range, taking into account a fixed hysteresis of 5 %, the corresponding output relay re-energizes automatically after the set tripping delay  $t_v$  is complete. The LED R/T flashes during timing.

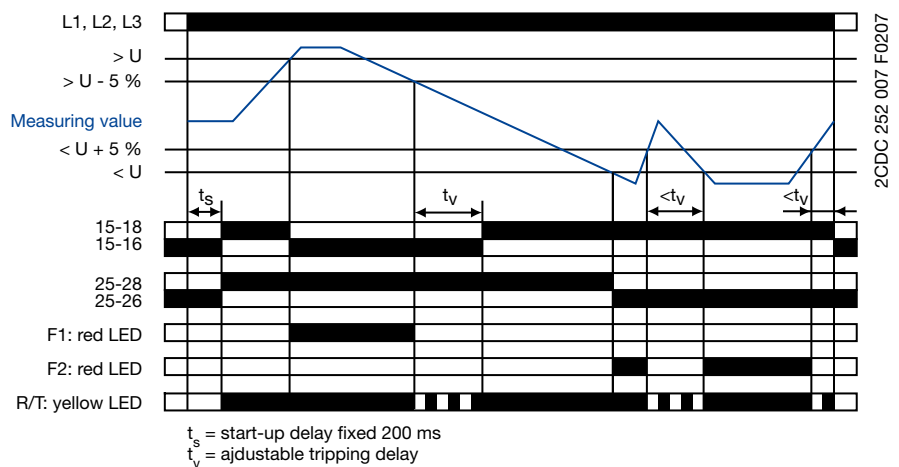

**NEW**

# Multifunctional three-phase monitoring relays

## CM-MPN.52, CM-MPN.62 and CM-MPN.72

### Data sheet

#### Phase unbalance monitoring

Applying control supply voltage begins the fixed start-up delay  $t_s$ . When  $t_s$  is complete and all phases are present with correct voltage and with correct phase sequence, the output relays energize and the yellow LED R/T glows.

#### Type of tripping delay = ON-delay ☒

If the voltage to be monitored exceeds or falls below the set phase unbalance threshold value, the output relays de-energize after the set tripping delay  $t_v$  is complete. The LED R/T flashes during timing and turns off as soon as the output relays de-energize.

The output relays re-energize automatically as soon as the voltage returns to the tolerance range, taking into account a fixed hysteresis of 20 %. The LED R/T glows.

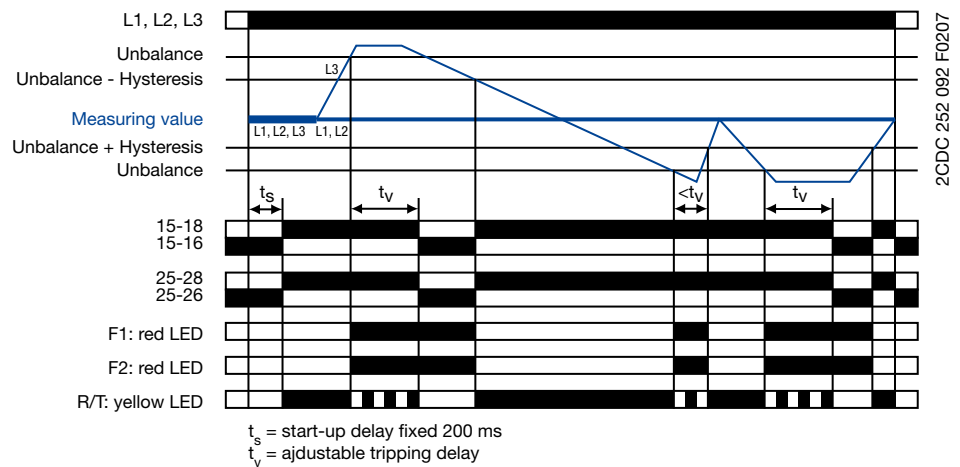

#### Type of tripping delay = OFF-delay ■

If the voltage to be monitored exceeds or falls below the set phase unbalance threshold value, the output relays de-energize instantaneously and the LED R/T turns off.

As soon as the voltage returns to the tolerance range, taking into account a fixed hysteresis of 20 %, the output relays re-energize automatically after the set tripping delay  $t_v$  is complete. The LED R/T flashes during timing and turns steady when timing is complete.

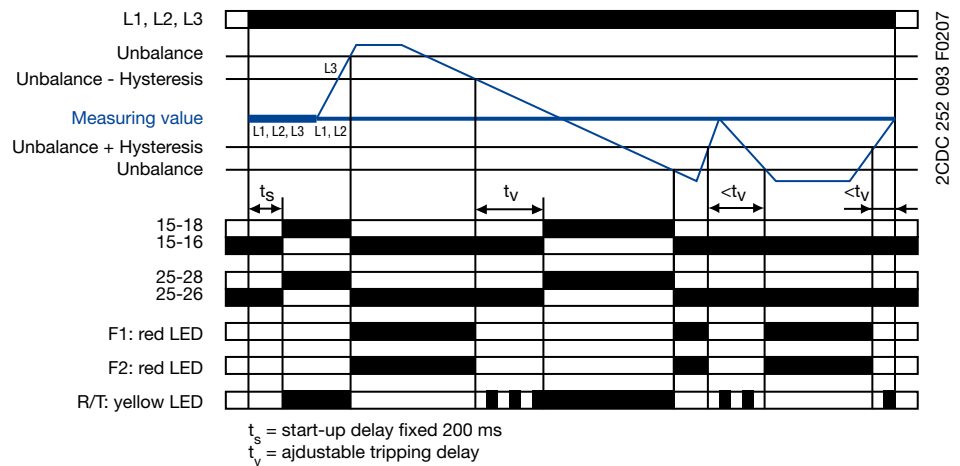

**NEW**

# Multifunction three-phase monitoring relays

## CM-MPN.52, CM-MPN.62 and CM-MPN.72

### Data sheet

#### Automatic phase sequence correction

This function can be selected only if phase sequence monitoring is activated  (DIP switch 3 = ON) and operating mode 2x1 c/o (SPDT) contact  is selected (DIP switch 2 = OFF).

Applying control supply voltage begins the fixed start-up delay  $t_{s1}$ . When  $t_{s1}$  is complete and all phases are present with correct voltage, output relay R1 energizes. Output relay R2 energizes when the fixed start-up delay  $t_{s2}$  is complete and all phases are present with correct phase sequence. Output relay R2 remains de-energized if the phase sequence is incorrect.

If the voltage to be monitored exceeds or falls below the set threshold values for phase unbalance, over- or undervoltage or if a phase failure occurs, output relay R1 de-energizes and the LEDs F1 and F2 indicate the fault.

Output relay R2 is responsive only to a false phase sequence. In conjunction with a reversing contactor combination, this enables an automatic correction of the rotation direction. See circuit diagrams.

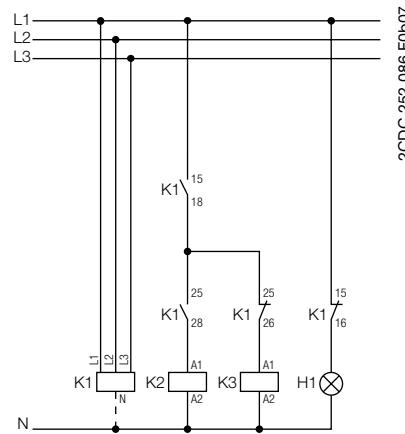
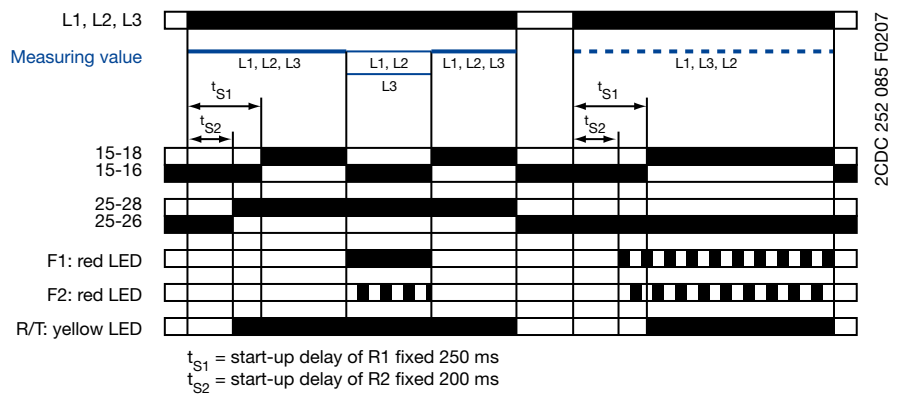

Control circuit diagram (K1 = CM-MPN.x2)

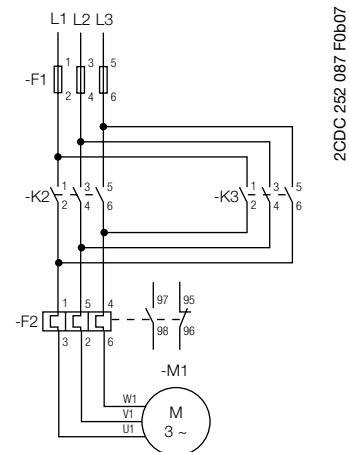

Power circuit diagram

**NEW**

# Multifunctional three-phase monitoring relays

CM-MPN.52, CM-MPN.62 and CM-MPN.72  
Data sheet

## Connection diagram

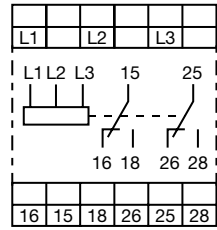

2CDC 252 038 F0b08

L1, L2, L3  
15-16/18  
25-26/28

Control supply voltage = measuring voltage  
Output contacts -  
closed-circuit principle

**CM-MPN.52, CM-MPN.62, CM-MPN.72**

**NEW**

# Multifunctional three-phase monitoring relays

## CM-MPN.52, CM-MPN.62 and CM-MPN.72

### Data sheet

Data at  $T_a = 25\text{ °C}$  and rated values, if nothing else indicated

Type		CM-MPN.52	CM-MPN.62	CM-MPN.72
<b>Input circuit = Measuring circuit</b>		<b>L1, L2, L3</b>		
Rated control supply voltage $U_s =$ measuring voltage		3x350-580 V AC	3x450-720 V AC	3x530-820 V AC
Rated control supply voltage $U_s$ tolerance		-15...+10 %		
Rated frequency		50/60 Hz		
Frequency range		45-65 Hz		
Typical current / power consumption		29 mA / 41 VA (480 V AC)	29 mA / 52 VA (600 V AC)	29 mA / 59 VA (690 V AC)
<b>Measuring circuit</b>		<b>L1, L2, L3</b>		
Monitoring functions	Phase failure	■	■	■
	Phase sequence	can be switched off	can be switched off	can be switched off
	Automatic phase sequence correction	configurable	configurable	configurable
	Over-/undervoltage	■	■	■
	Phase unbalance	■	■	■
	Interrupted neutral	-	-	-
Measuring range	Overvoltage	3x480-580 V AC	3x600-720 V AC	3x690-820 V AC
	Undervoltage	3x350-460 V AC	3x450-570 V AC	3x530-660 V AC
	Phase unbalance	2-25 % of average of phase voltages		
Thresholds	Overvoltage	adjustable within measuring range		
	Undervoltage	adjustable within measuring range		
	Phase unbalance (switch-off value)	adjustable within measuring range		
Hysteresis related to the threshold value	Over-/undervoltage	fixed 5 %		
	Phase unbalance	fixed 20 %		
Rated frequency of the measuring signal		50/60 Hz		
Frequency range of the measuring signal		45-65 Hz		
Maximum measuring cycle time		100 ms		
Measuring error within the rated control supply voltage tolerance		≤ 0.5 %		
Measuring error within the temperature range		≤ 0.06 % / °C		
Measuring method		True RMS		
<b>Timing circuit</b>				
Start-up delay $t_{s1}$ and $t_{s2}$		fixed 200 ms		
Start-up delay $t_{s1}$		fixed 250 ms		
Tripping delay $t_v$		ON- or OFF-delay 0; 0.1-30 s adjustable		
Repeat accuracy (constant parameters)		< ±0.2 %		
Timing error within the rated control supply voltage tolerance		≤ 0.5 %		
Timing error within the temperature range		≤ 0.06 % / °C		
<b>Indication of operational states</b>		1 yellow LED, 2 red LEDs Details see operating mode and function description/diagrams		
<b>Output circuits</b>		<b>15-16/18, 25-26/28</b>		
Kind of output		2x1 or 1x2 c/o (SPDT) contacts configurable (Relays)		
Operating principle <sup>1)</sup>		closed-circuit principle		
Contact material		AgNi alloy, Cd free		
Rated voltage (VDE 0110, IEC 60947-1)		250 V		
Minimum switching power		24 V / 10 mA		
Maximum switching voltage		see load limit curve		
Rated operational current (IEC/EN 60947-5-1)	AC12 (resistive) 230 V	4 A		
	AC15 (inductive) 230 V	3 A		
	DC12 (resistive) 24 V	4 A		
	DC13 (inductive) 24 V	2 A		
AC rating (UL 508)	Utilization category (Control Circuit Rating Code)	B 300		
	max. rated operational voltage	300 V AC		
	max. continuous thermal current at B 300	5 A		
	max. making/breaking apparent power at B 300	3600/360 VA		

**NEW**

# Multifunctional three-phase monitoring relays

## CM-MPN.52, CM-MPN.62 and CM-MPN.72

### Data sheet

Data at  $T_a = 25\text{ °C}$  and rated values, if nothing else indicated

Type	CM-MPN.52	CM-MPN.62	CM-MPN.72
Mechanical lifetime	30 x 10 <sup>6</sup> switching cycles		
Electrical lifetime (AC12, 230 V, 4 A)	0,1 x 10 <sup>6</sup> switching cycles		
Short-circuit proof,	n/c contact	10 A fast-acting	
maximum fuse rating	n/o contact	10 A fast-acting	
<b>General data</b>			
Duty time	100 %		
Dimensions (W x H x D)	45 x 78 x 100 mm (1.78 x 3.07 x 3.94 inch)		
Weight	0.22 kg (0.49 lb)		
Mounting	DIN rail (EN 60715), snap-on mounting without any tool		
Mounting position	any		
Minimum distance to other units	not necessary		
Degree of protection	enclosure / terminals	IP50 / IP20	
<b>Electrical connection</b>			
Wire size	fine-strand with(out) wire end ferrule	2 x 0.75-2.5 mm <sup>2</sup> (2 x 18-14 AWG)	
	rigid	2 x 0.5-4 mm <sup>2</sup> (2 x 20-12 AWG)	
Stripping length	7 mm (0.28 inch)		
Tightening torque	0.6-0.8 Nm		
<b>Environmental data</b>			
Ambient temperature ranges	operation / storage	-25...+60 °C / -40...+85 °C	
Damp heat (IEC 60068-2-30)	55 °C, 6 cycles		
Climatic category	3K3		
Vibration (sinusoidal) (IEC/EN 60255-21-1)	Class 2		
Shock (IEC/EN 60255-21-2)	Class 2		
<b>Isolation data</b>			
Rated insulation	input circuit / output circuit	1000 V	
voltage $U_i$	output circuit 1 / output circuit 2	300 V	
Rated impulse withstand voltage $U_{imp}$	input circuit	8 kV; 1.2/50 $\mu$ s	
(VDE 0110, IEC/EN 60664)	output circuit	4 kV; 1.2/50 $\mu$ s	
Test voltage	isolated output circuits	2.5 kV, 50 Hz, 1 s	
(type test) between	input circuit and isolated output circuits	4 kV, 50 Hz, 1 s	
Basis isolation	input circuit / output circuit	1000 V	
Protective separation (VDE 0160 part 101 and 101/A, IEC/EN 61140)	input circuit / output circuit	-	
Pollution degree (VDE 0110, IEC/EN 60664, UL 508)	3		
Overvoltage category (VDE 0110, IEC 60664, UL 508)	III		
<b>Standards</b>			
Product standard	IEC/EN 60255-6, EN 50178		
Low Voltage Directive	2006/95/EC		
EMC directive	2004/108/EC		
RoHS directive	2002/95/EC		
<b>Electromagnetic compatibility</b>			
Interference immunity	EN 61000-6-1, EN 61000-6-2		
electrostatic discharge (ESD)	IEC/EN 61000-4-2	Level 3 (6 kV / 8 kV)	
electromagnetic field (HF radiation resistance)	IEC/EN 61000-4-3	Level 3 (10 V/m)	
fast transients (Burst)	IEC/EN 61000-4-4	Level 3 (2 kV / 2 kHz)	
powerful impulses (Surge)	IEC/EN 61000-4-5	Level 4 (2 kV L-L)	
HF line emission	IEC/EN 61000-4-6	Level 3 (10 V)	
Resistance to harmonics	EN 61000-4-13	Class 3	
Interference emission	EN 61000-6-3, EN 61000-6-4		
electromagn. field (HF radiation resistance)	IEC/CISPR 22, EN 50022	Class B	
HF line emission	IEC/CISPR 22, EN 50022	Class B	

<sup>1)</sup> Closed-circuit principle: Output relay(s) de-energize(s) if measured value exceeds or falls below the adjusted threshold value

**NEW**

# Multifunctional three-phase monitoring relays

CM-MPN.52, CM-MPN.62 and CM-MPN.72  
Data sheet

## Technical diagrams

### Load limit curves

#### AC load (resistive)

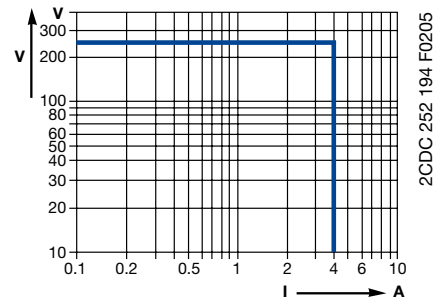

#### DC load (resistive)

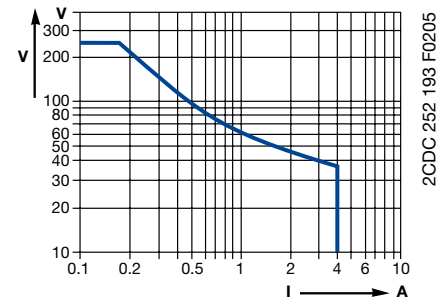

### Derating factor F

#### at inductive AC load

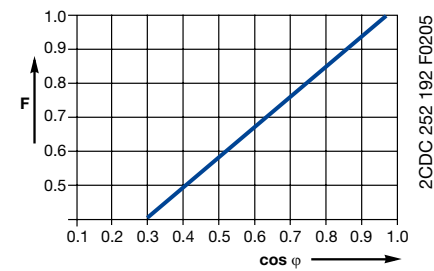

### Contact lifetime

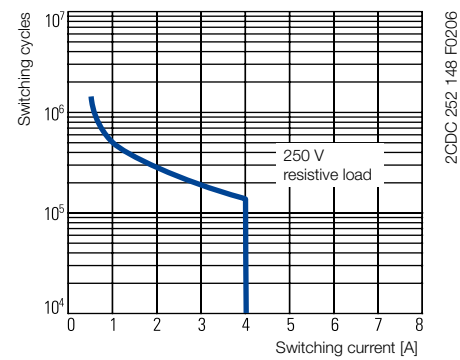

**NEW**

# Multifunctional three-phase monitoring relays

CM-MPN.52, CM-MPN.62 and CM-MPN.72  
Data sheet

## Dimensions

in mm

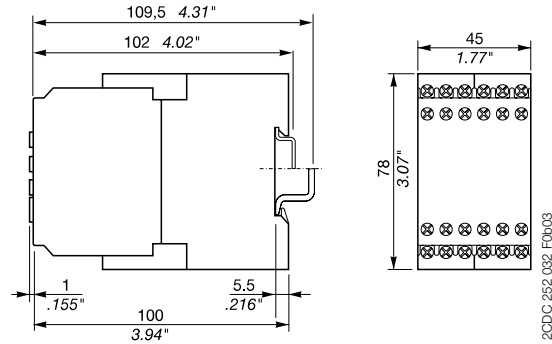

## Dimensions - Accessories

in mm

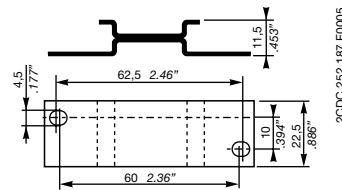

**ADP.01 - Adapter for screw mounting**

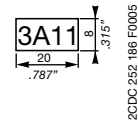

**MAR.02 - Marker label**

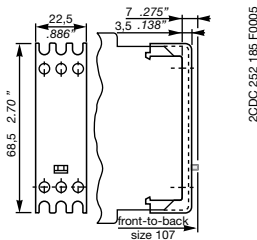

**COV.01 - Sealable transparent cover**

## Further documentation

Document title	Document type	Document number
Electronic Products and Relays	Technical catalogue	2CDC 110 004 C020x
CM-MPS.23, CM-MPS.43, CM-MPN.52, CM-MPN.62, CM-MPN.72	Instruction manual	1SVC 630 530 M0000

You can find the documentation online at [www.abb.com/lowvoltage](http://www.abb.com/lowvoltage) → Control Products → ...



As part of the on-going product improvement, ABB reserves the right to modify the characteristics of the products described in this document. The information given is non-contractual.

For further details please contact ([www.abb.com/contacts](http://www.abb.com/contacts)) the ABB company marketing these products in your country.

---

**ABB STOTZ-KONTAKT GmbH**

Eppelheimer Straße 82, 69123 Heidelberg, Germany  
Postfach 10 16 80, 69006 Heidelberg, Germany  
Internet <http://www.abb.com/lowvoltage> → Control Products

You can find the address of your local sales organisation on the ABB home  
<http://www.abb.com/contacts> → Low Voltage products