

**FLUKE®**

**312, 316, 318**

Clamp Meter

用户手册

PN 1989445

July 2002 Rev. 2, 2/06

© 2002, 2006 Fluke Corporation, All rights reserved. Printed in China.

All product names are trademarks of their respective companies.

## 有限保证和有限责任

本款 **Fluke** 公司的产品保证没有材料和工艺上的缺陷，保证期从购买之日起为一年。此项保证不包括保险丝、普通电池，也不包括由于意外情况、疏于管理、错误使用、经过改动、受到污染或不正常的操作或搬运条件所引起的损坏。代理商无权以 **Fluke** 的名义扩大任何其它的保证条款。欲在保证期内获得维修服务，请将本产品退回购货点并附以故障情况说明。

这种保证是您唯一的补救方法。任何其它的保证条款（如为某种特定目的的适应性）均未表述或默许。**FLUKE** 对于任何特别的、间接的、意外的或后果性的，由于任何原因或理论引起的损坏或丢失都不承担责任。由于某些州或者国家不允许排斥或者限制默认保证条款或者意外的或后果性的损坏，此项有限责任可能不适用于您。

**Fluke Corporation**  
**P.O. Box 9090**  
**Everett, WA 98206-9090**  
**U.S.A.**

维修站地址：

美国福禄克公司北京办事处

北京建国门外大街 22 号赛特大厦 2301 室

电话：010—65123435

上海世禄仪器有限公司

上海市虹梅南路 2638 弄 139 号

邮编：201108

标准号：Q/SXAV 2—2002

# 目录

标题	页数
安全信息 – 首先阅读.....	1
一般技术指标.....	4
电气性能技术指标.....	5
仪器概述 功能位置.....	6
符号定义.....	7
进行测量.....	7
测量 AC 电流.....	8
测量 DC 电流 (仅限 316, 318).....	9
测量 AC 和 DC 电压.....	9
测量电阻.....	12
测量通断性.....	13
二极管测试.....	14
数据保持.....	15
峰值.....	15
MIN MAX (仅限 316, 318).....	15
REL ( $\Delta$ ) (仅限 316, 318).....	16
量程 (仅限 312).....	16
更换电池.....	16
仪表的清洁工作.....	16
维护.....	16



## 安全信息 - 首先阅读

### △警告：使用前首先阅读

为了避免可能发生的电击或人身伤害：

- 只能按照本手册的规定来使用此仪表，否则仪表提供的保护能力可能受到损害。
- 请勿在潮湿的环境下使用此仪表。
- 使用前应检查仪表。如果发现损坏请勿使用此仪表。请注意发现仪表的破损处或丢失的塑料零件。特别要注意连接器周围的绝缘情况。
- 使用前应检查测试线。如果发现其绝缘损坏或金属暴露，请不要再使用。请检查测试线的通断性。使用本仪表之前请首先更换损坏的测试线。
- 本仪表只能由有资格的维修人员进行维修。
- 请勿在仪表的端子之间或任何一个端子和大地之间施加高于仪表上标示出的额定电压值的电压。
- 打开仪表的机壳之前，请将测试线从仪表上取下。
- 绝对禁止在拆掉仪表后盖或打开仪表机壳的情况下使用本仪表。
- 在没有切断电源的情况下，绝对禁止拆掉仪表后盖或打开仪表机壳。
- 当工作电压高于 AC 有效值 33 V、AC 峰值 46.7 V 或 DC 70 V 时，应小心从事。这类电压会引起电击的危险。
- 在测量工作中应使用恰当的接线端子、合适的功能和量程。
- 请勿在爆炸性气体、蒸汽或尘埃的环境中使用此仪表。
- 使用探头时，请将手指放在探头的手指保护环之后。
- 进行电气连接时，应先连接公共测试线，后连接火线测试线；切断电气连接时，应先切断火线测试线，在切断公共测试线。

- 在测试电阻、通断性或二极管之前，应先切断电路的电源并将所有的高压电容放电。
- 只可使用单个的 9 V 电池来为本仪表供电，并应将电池妥善地安装在仪表的机壳内。
- 当电池不足指示符号 (■) 出现时，应立即更换电池以避免可能导致电击或人身伤害的错误读数。
- 在使用前和使用后用一个已知的源来检查本仪表的工作状况。
- 维修时只能使用规定的替换零件。
- 遵守当地和国家安全法规。在危险带电导线外露的环境中，必须使用工业保护设备来防止触电和电弧放电的伤害。
- 使用电流探头时，请将手指放在探头的手指保护环之后（见图 1）。

**环境条件：**

**高度：**可达 2000 米。

**工作温度：**0 °C ~ 30 °C，相对湿度可达 90 %，不结露。

30 °C ~ 40 °C，相对湿度可达 80 %，不结露。









**贮存温度：**-10 °C ~ 60 °C，拆去电池。

**污染等级：**2

**测量类别：**CAT III (600 V)，CAT II (1000 V)

**电磁兼容性：**3V/m，性能标准 B

## 符号的说明

	危险。重要的信息。参见操作手册。
	有触电危险。
	允许在危险的、有电的导体上使用或移开。
	双层绝缘。
	电池
	大地
	交流
	直流
CAT II	设备的设计能够保护由固定安装供电的耗能设备，如电视机、个人计算机、便携式工具和其它家用电器产生的瞬变。
CAT III	设备的设计能够保护由固定设备安装的设备，如大型建筑中的配电盘、馈线及短分支电路和照明系统中的瞬变。
CE	符合欧洲标准 EN/IEC 61010-1 第二版和 EN/IEC 61010-02-032

## 一般技术指标

**数字显示:** 3-3/4 位, 最大读数为 3999

**模拟显示:** 快速 42-段模拟条图显示器

**过载:** 在 40 A、400 A、电阻和通断性功能中, 当输入信号超过测量限制值时显示 **OL**

### 注意

在电压和电流功能中, LCD 可以继续显示超过测量限制值的数值 (达 4000 个字)。参见测量限制值的技术指标

**采样速率:** 对数字显示为 2 次/秒, 对模拟条图显示为 20 次/秒

**电池不足指示:** 当电池电压低于其需要的电压值时显示 

**电源:** 9 V 电池, NEDA1604 或 6F22 或 006P

**电池寿命:**

(碱性电池):

在 **A** 功能时典型值为 33 小时

在  功能时典型值为 65 小时

在 **V, Ω** 功能时典型值为 100 小时

**自动关机:** 如果没有进行按键或旋转开关操作的时间达 30 分钟, 则本仪表将自动关机。在再次启动仪表的电源之前, 应将旋转开关转至“关闭”(OFF)位置。

如欲关掉此自动关机功能, 按压并按住峰值按键, 再开机即可。

**卡钳开口尺寸:**

312: 36 mm (1.42 英寸)

316、318: 40 mm (1.57 英寸)

**尺寸 (长 x 宽 x 高):** 254 x 66 x 37 mm (10 x 2.60 x 1.45 英寸)

**重量:** 422 g (14.9 盎司) (包括电池)

**随机附件:** 用户手册、携带箱、测试线、9 V 电池

**认证标准:** , EN61010 600 V CAT III, 1000 V CAT II, CMC

## 电气性能技术指标

准确度技术指标定义为在  $23\text{ }^{\circ}\text{C} \pm 5\text{ }^{\circ}\text{C}^1$  时的  $\pm$  (% 读数 + 字)。

功能	量程	分辨率	准确度 (% 读数 + 字)	
			312	316 & 318
AC 电流 <sup>2</sup> (50 ~ 500 Hz)	40.00 A 400.0 A 1000 A	0.01 A 0.1 A 1 A	1.9 % $\pm$ 5	1.9 % $\pm$ 5 (50 ~ 60 Hz)
				2.5 % $\pm$ 5 (60 - 500 Hz)
DC 电流	40.00 A 400.0 A 1000 A	0.01 A 0.1 A 1 A	-	2.5 % $\pm$ 10
AC 电压 <sup>2</sup> (50 ~ 500 Hz)	400.0 V 750 V	0.1 V 1 V	1.2 % $\pm$ 5	1.5 % $\pm$ 5
DC 电压	400.0 V 1000 V	0.1 V 1 V	0.75 % $\pm$ 2	1 % $\pm$ 2
电阻 (欧姆)	400.0 $\Omega$ 4000 $\Omega$	0.1 $\Omega$ 1 $\Omega$	1 % $\pm$ 3	1 % $\pm$ 3
通断性	通时 < 50 $\Omega$			
二极管测试	达 2 V			
Min Max	500 ms acquisition time			
输入阻抗	10 M $\Omega$			
自动关机	30 min $\pm$ 2 min 之后。在 MIN MAX 功能时关闭。开机时可以选择关闭此功能（按住峰值按键）。			
自动量程	在下列测量功能时有效：电压和电阻（仅限 312 的电压功能）。			
过载保护	600 Vrms, 按照 EN61010 CAT III 600 V			
1. 温度系数：0.1 x (规定的准确度) / $^{\circ}\text{C}$ (< 18 $^{\circ}\text{C}$ 或 > 28 $^{\circ}\text{C}$ ) 2. ac 电压和 ac 电流的真有效值准确度系在量程的 5 % 到 100 % 的范围内给出。40 A 和 400 A 量程的波峰因数（50 ~ 60 Hz）最大为 3.0。100 A 量程的波峰因数最大为 1.4（仅限 318）。 3. 如果电流高于 400 A，测量时间应限制在 5 分钟以内，然后进行为时 15 分钟的冷却。				

## 仪器概述

### 功能位置

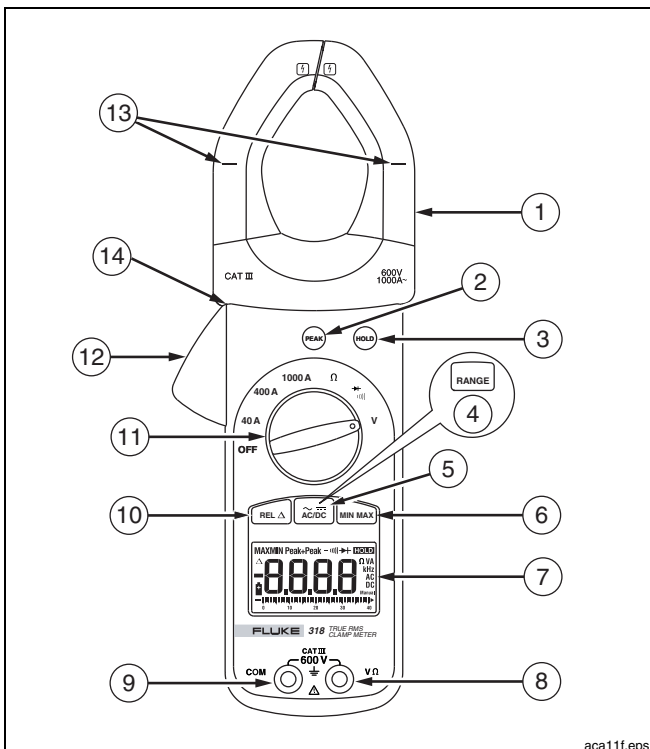

aca11f.eps

①	电流检测卡钳	⑧	VΩ 输入端子
②	峰值按键	⑨	COM 端子
③	保持按键	⑩	REL 按键 (316, 318)
④	量程按键 (312)	⑪	旋转功能开关
⑤	AC/DC 按键 (316, 318)	⑫	卡钳开启扳机
⑥	MIN MAX 按键 (316, 318)	⑬	导线对正标记
⑦	LCD	⑭	手指保护环

图 1. 功能位置 (所示为 318)

## 符号定义

①	<b>MAX</b> 最大读数时显示 (仅限 316, 318) <b>MIN</b> 最小读数时显示 (仅限 316, 318)	⑧	AC 模式
②	相对 ( $\Delta$ ) 模式有效	⑨	<b>V</b> 伏特 <b>A</b> 安培
③	负读数	⑩	$\Omega$ 欧姆
④	电池不足应予更换	⑪	选择保持功能
⑤	条图	⑫	选择二极管/通断性测试功能
⑥	手动量程模式	⑬	选择-峰值功能
⑦	DC 模式	⑭	选择+峰值功能

aca02f.eps

图 2. LCD 符号的解释

## 进行测量

## ⚠警告

- 测量电流时，请用卡钳上的对齐标记将被测导线放在卡钳的中央。
- 进行电流测量时，为避免受到电击请将测试线从仪表上取下。
- 条图仅供参考，并不表示实际测量值或范围。采用主显示读取实际测量值和范围。

## 测量 AC 电流

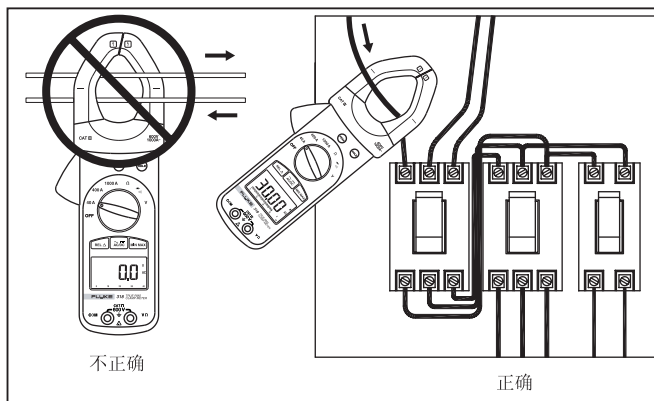

1. 将旋转功能开关旋到适当的电流量程。
2. 如果必要，按  $\tilde{\square}$  按键 (仅限 316, 318) 以测量 ac 电流
3. 按压卡钳打开扳机以打开卡钳，将被测的导线夹入卡钳。
4. 关闭卡钳并使用对正标记使导线处于中间位置。
5. 观察 LCD 上的读数。



aca13f.eps

图 3. 连接钳形表 (所示为 318)

## 测量 DC 电流 (仅限 316, 318)

1. 转动旋转功能开关至适当的电流量程。
2. 按  按键以测量 dc 电流。
3. 为保证测量准确度，等待读数稳定之后再按  以便对读数进行零点调整。
4. 按压卡钳打开扳机以打开卡钳，将被测的导线夹入卡钳。
5. 关闭卡钳并使用对正标记使导线处于中间位置。
6. 观察 LCD 上的读数。

## 测量 AC 和 DC 电压

1. 转动旋转功能开关至 **V**。
2. 按  按键选择 ac 或 dc (仅限 316, 318)。  
当使用 312 仪表时：
  - 当测量 ac 电压时，转动旋转功能开关至  $\tilde{V}$
  - 当测量 dc 电压时，转动旋转功能开关至  $\bar{V}$
3. 将黑色测试线连至 **COM** 端子，将红色测试线连至 **VΩ** 端子。
4. 用探头探触希望的电路测试点以测量电压。
5. 观察 LCD 上的读数。

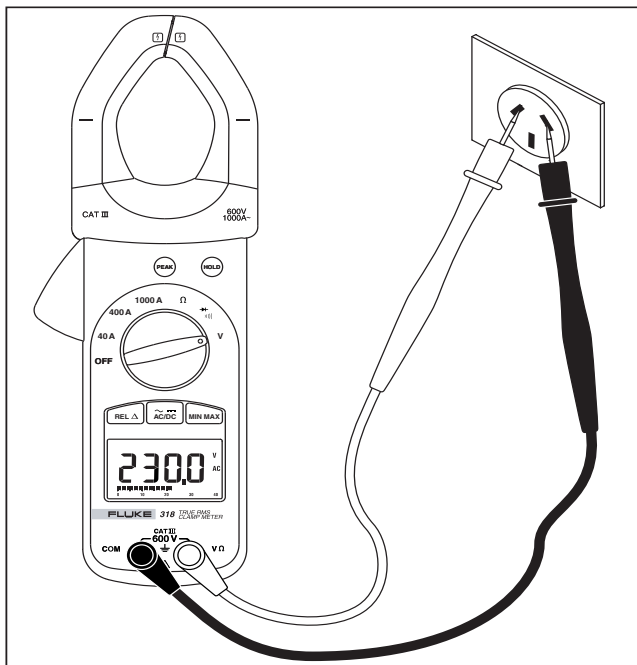

aca14f.eps

图 4. AC 电压测量 (所示为 318)

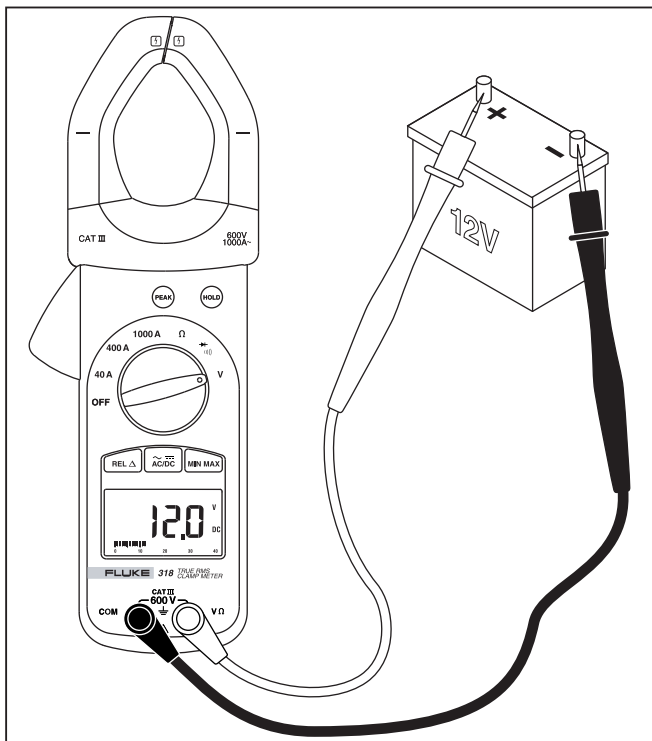

aca15f.eps

图 5. DC 电压测量 (所示为 318)

## 测量电阻

### ⚠ 警告

为了避免电击，在测量电路中的电阻时应确保切断电路的电源并将所有的电容放电。

1. 转动旋转功能开关至  $\Omega$ 。切断被测电路的电源。
2. 将黑色测试线连至 **COM** 端子，将红色测试线连至 **V $\Omega$**  端子。
3. 用探头探触希望的电路测试点以测量电阻。
4. 观察 LCD 上的读数。

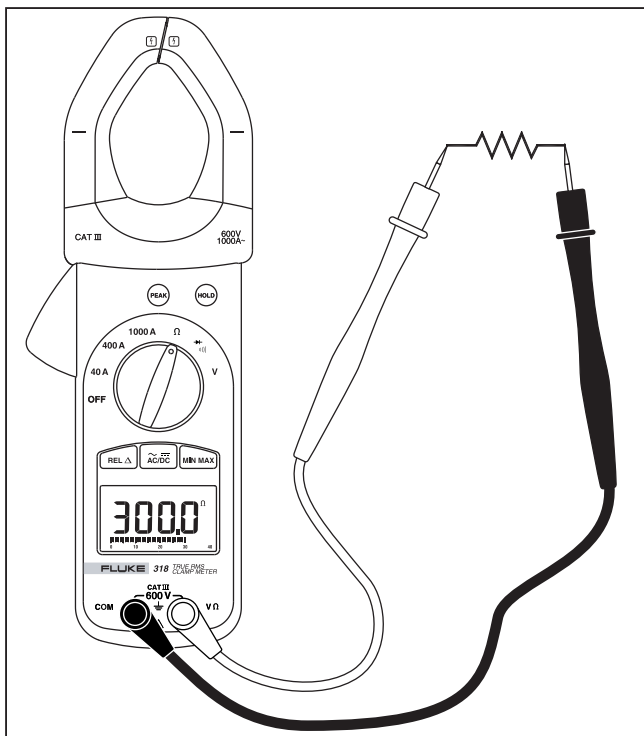

aca16f.eps

图 6. 测量电阻 (所示为 318)

## 测量通断性

### ⚠ 警告

为了避免电击，在测量电路中的通断性时应确保切断电路的电源并将所有的电容放电。

1. 转动旋转功能开关至  $\text{b} \text{ } \text{|||}|$ 。切断被测电路的电源。
2. 将黑色测试线连至 **COM** 端子，将红色测试线连至 **V $\Omega$**  端子。
3. 将探头跨接在被测的电路或元件上。

如果电阻值低于  $50 \Omega$ ，则蜂鸣器将连续鸣响，表明短路状态。如果仪表显示为 **OL**，则为开路。

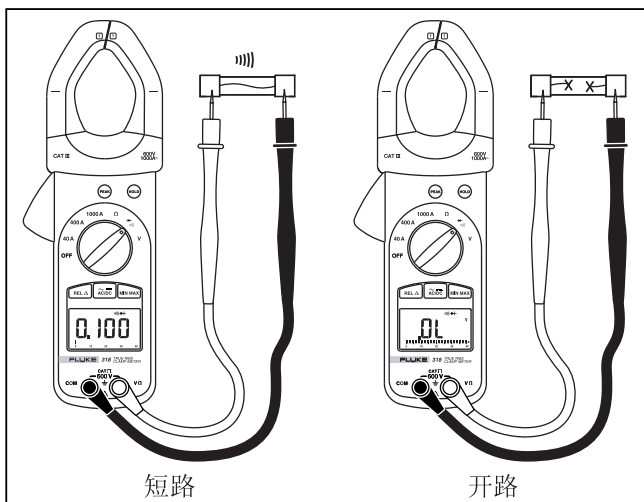

aca17f.eps

图 7. 测量通断性 (所示为 318)

## 二极管测试

### ⚠ 警告

为了避免电击，在测量电路中的二极管时应确保切断电路的电源并将所有的电容放电。

1. 转动旋转功能开关至  $\rightarrow$ 。切断被测电路的电源。
2. 将黑色测试线连至 **COM** 端子，将红色测试线连至 **V $\Omega$**  端子。
3. 将黑色测试线连至被测二极管的阴极，将红色测试线连至被测二极管的阳极。
4. 在 LCD 上读出被测二极管的正向偏置电压值。
5. 如果测试线的极性和二极管的极性相反，则 LCD 显示“OL”。这一点可以用来区分二极管的阳极和阴极。

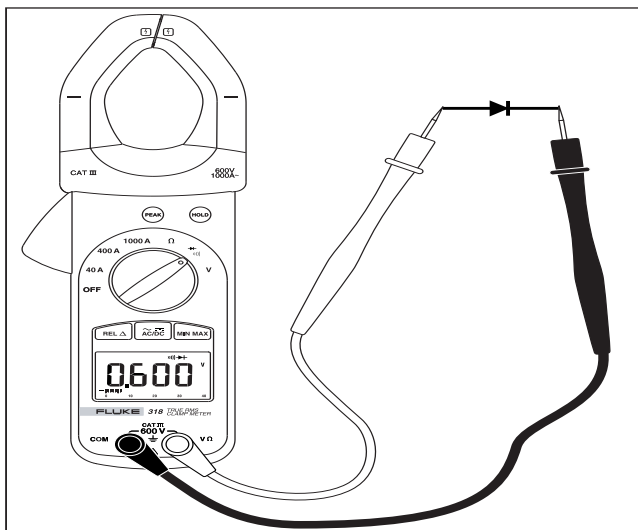

aca18f.eps

图 8. 二极管测试 (所示为 318)

### ⚠ 警告

危险的电压可能出现在仪表的输入端，并且此电压可能不显示出来。

## 数据保持

欲保持当前的数据，按 HOLD 按键。再按此按键则回到活动读数状态。

## 峰值

在使用 ACA、DCA (316, 318)、ACV 和 DCV 功能时，本仪表具有 1 ms 的峰值特性。在进行峰值保持测量之前，峰值特性必须按下述的方法进行校准：





1. 按压并按住峰值按键 2 秒钟。这时 LCD 上出现 CAL 指示以表示仪表已经计算出偏移数值并贮存在仪表中。
2. 校准之后，按一次峰值按键以进入+峰值模式，并开始显示+峰值数值。
3. 再按一次峰值按键以进入-峰值模式，并开始显示-峰值数值。
4. 按住峰值按键 2 秒钟，使仪表回到正常工作状态。

如果在校准以后改变了旋转功能开关的位置，那么在进行下一次峰值测量之前必须再重复进行校准步骤。



### 注意

峰值模式连续地更新 LCD 显示的数值以显示最大的幅度值。不显示较小的幅度值



## MIN MAX (仅限 316, 318)

1. 按  按键一次将仪表设置成 MAX 模式。
2. 再按  按键一次将仪表设置成 MIN 模式。
3. 再按  按键一次，则仪表显示当前的读数，并跟踪 MAX 和 MIN 值。此模式由 LCD 上闪动的 MAXMIN 符号来表示。
4. 按住  按键达 2 秒钟，则将仪表设置返回到正常工作状态。

## REL ( $\Delta$ ) (仅限 316, 318)

1. 按  按键则将零点设置成仪表当前的读数。而仪表显示以后的读数与该参考读数之差。
2. 按  按键一次，仪表显示该参考读数。在 LCD 上闪动的  $\Delta$  也表示出这种模式。
3. 按住  按键 达 2 秒钟，将使仪表返回到正常工作状态。

## 量程 (仅限 312)

按  选择手动量程模式。这时 LCD 上将显示 **Manual**，并且仪表将保持在同一个量程。要退出手动量程模式并返回自动量程模式，按压并按住  按键 1 秒钟。

## 更换电池

当电池电压低于正常工作所需要的电压数值时，在 LCD 上将会出现电池符号。

1. 在更换电池之前，请关闭仪表电源并拆除测试线。
2. 用螺丝刀打开仪表后盖。
3. 用新的 9 V 电池替换原来的电池。
4. 扣好后盖并上紧螺丝钉。

## 仪表的清洁工作

定期用干布擦拭仪表进行清洁工作。不要对本仪表使用研磨剂或者溶剂。

## 维护

### $\Delta$ 警告

- 为避免电击，在拆掉后盖之前请从仪表上取下测试线。切勿在打开后盖的情况下使用本仪表。
- 本手册中未涉及的修理或维护工作只应由有资格的技术人员进行。

### 小心

- 为避免污染或静电损坏，请勿在没有适当静电防护的情况下触摸电路板。
- 如果长时间不使用本仪表，请拆掉电池。不要在高温或高潮湿的环境下存放本仪表。

**FLUKE®**

# **312, 316, 318**

Clamp Meter

Users Manual

PN 1989445

July 2002 Rev.2, 2/06

© 2002, 2006 Fluke Corporation. All rights reserved. Printed in China.

All product names are trademarks of their respective companies.

## **LIMITED WARRANTY AND LIMITATION OF LIABILITY**

This Fluke product will be free from defects in material and workmanship for one year from the date of purchase. This warranty does not cover fuses, disposable batteries, or damage from accident, neglect, misuse, alteration, contamination, or abnormal conditions of operation or handling. Resellers are not authorized to extend any other warranty on Fluke's behalf. To obtain service during the warranty period, return the unit to point of purchase with a description of the problem.

**THIS WARRANTY IS YOUR ONLY REMEDY. NO OTHER WARRANTIES, SUCH AS FITNESS FOR A PARTICULAR PURPOSE, ARE EXPRESSED OR IMPLIED. FLUKE IS NOT LIABLE FOR ANY SPECIAL, INDIRECT, INCIDENTAL OR CONSEQUENTIAL DAMAGES OR LOSSES, ARISING FROM ANY CAUSE OR THEORY.** Since some states or countries do not allow the exclusion or limitation of an implied warranty or of incidental or consequential damages, this limitation of liability may not apply to you.

Fluke Corporation  
P.O. Box 9090  
Everett, WA 98206-9090  
U.S.A.

Service Center Address:  
Fluke Corporation Beijing Service Center  
Room 2301 Scite Tower  
22 Jianguomenwai Dajie, Chao Yang District  
Beijing 100004, PRC  
Tel: 010-65123435

Shanghai ShiLu Instrument Co., Ltd.  
No. 139, Lane 2638, Hongmei South Road  
Shanghai 201108  
Standard No. Q/SXAV 2-2002

# ***Table of Contents***

<b>Title</b>	<b>Page</b>
Safety Information – Read first .....	1
General Specifications .....	4
Electrical Specifications.....	5
Instrument Overview Feature Locations .....	6
Symbol Definition .....	7
Making Measurements .....	7
Measuring AC Current .....	8
Measuring DC Current (316, 318 only) .....	9
Measuring AC and DC Voltage .....	9
Measuring Resistance .....	12
Testing Continuity .....	13
Diode Test.....	14
Data Hold.....	15
Peak.....	15
MIN MAX (316, 318 only).....	15
REL ( $\Delta$ ) (316, 318 only) .....	16
Range (312 only) .....	16
Changing the Battery.....	16
Cleaning the Meter .....	16
Maintenance.....	16



## **Safety Information – Read first**

### **⚠ Warnings: Read Before Using**

To avoid possible electric shock or personal injury:

- Use the Meter only as specified in this manual or the protection provided by the Meter might be impaired.
- Do not use the Meter in wet environments.
- Inspect the Meter before using it. Do not use the Meter if it appears damaged. Look for cracks or missing plastic. Pay particular attention to the insulation around the connectors.
- Inspect the test leads before use. Do not use them if insulation is damaged or metal is exposed. Check the test leads for continuity. Replace damaged test leads before using the Meter.
- Have the Meter serviced only by qualified service personnel.
- Do not apply more than the rated voltage, as marked on the Meter, between the terminals or between any terminal and earth ground.
- Remove test leads from the Meter before opening the Meter case.
- Never operate the Meter with the back cover removed or the case open.
- Never remove the back cover or open the case of an instrument without first removing the power source.
- Use caution when working with voltages above 33 V ac rms, 46.7 V ac peak, or 70 V dc. These voltages pose a shock hazard.
- Use the proper terminals, function, and range for your measurements.
- Do not operate the Meter around explosive gas, vapor, or dust.

- When using probes, keep your fingers behind the finger guards.
- When making electrical connections, connect the common test lead before connecting the live test lead; when disconnecting, disconnect the live test lead before disconnecting the common test lead.
- Disconnect circuit power and discharge all high-voltage capacitors before testing resistance, continuity, or diodes.
- Use only a single 9 V battery, properly installed in the Meter case, to power the Meter.
- Replace the battery as soon as the low battery indicator (🔋) appears to avoid false readings that can lead to electric shock and injury.
- Check Meter operation on a known source before and after use.
- When servicing, use only specified replacement parts.
- Adhere to local and national safety codes. Industrial protective equipment must be used to prevent shock and arc blast injury where hazardous live conductors were exposed.
- Do not hold the Current Probe anywhere beyond the tactile indicator (see Figure 1).

**Environmental Conditions:**

**Altitude:** up to 2000 meters.

**Operating temperature:** 0 °C ~ 30 °C, up to 90 % RH, non-condensing

30 °C ~ 40 °C, up to 80% RH, non-condensing









**Storage temperature:** -10 °C ~ 60 °C, battery removed

**Pollution Degree:** 2

**Measurement Categories:** CAT III (600 V), CAT II (1000 V)

**Electromagnetic Compatibility:** 3 V/m, performance criterion B

## Explanation of Symbols

	Risk of danger. Important information. Refer to operation instructions.
	Risk of electric shock.
	Application and removal from hazardous live conductors permitted.
	Double insulated.
	Battery
	Earth Ground
	Alternating current
	Direct current
CAT II	Equipment is designed to protect against transients from energy-consuming equipment supplied from the fixed installation, such as televisions, personal computers, portable tools, and other household appliances.
CAT III	Equipment is designed to protect against transients in equipment in fixed-equipment installations, such as distribution panels, feeders and short branch circuits, and lighting systems in large buildings.
CE	Complies with European standards EN/IEC 61010-1 2 <sup>nd</sup> Edition and EN/IEC 61010-02-032

## General Specifications

**Digital Display:** 3-3/4 digits with maximum reading of 3999

**Analog Display:** Fast 42-segment analog bar graph display

**Overload:** Displays **OL** when input signal exceeds measuring limit in 40 A, 400 A, resistance, and continuity functions.

### Note

*In Volts and Amps, the LCD may continue to display values above the indicated measuring limit (up to 4000 counts). Refer to specifications for measuring limits.*

**Sample Rate:** 2 times/sec for digital display; 20 times/sec for analog bar graph

**Low Battery Indication:** Displays  when the battery is below its required voltage

**Power Source:** 9 V battery, NEDA1604 or 6F22 or 006P

### Battery Life:

(Alkaline):

33 hrs typical in **A**

65 hrs typical in 

100 hrs typical in **V,  $\Omega$**

**Auto Power Off:** The Meter will power itself off if there is no push button or rotary function switch operation for 30 minutes. Turn the rotary switch to “OFF” before turning the Meter on again.

To deactivate this feature, press the Peak button and keep it pressed down while powering up the Meter.

### Clamp Opening Size:

312: 36 mm (1.42 inches)

316, 318: 40 mm (1.57 inches)

**Dimensions (L x W x H):** 254 x 66 x 37 mm (10 x 2.60 x 1.45 inches)

**Weight:** 422 g (14.9 ounces) (battery included)

**Included Accessories:** Users manual, carrying case, test leads, 9 V battery

**Approvals:** , EN61010 600 V CAT III, 1000 V CAT II, CMC

## Electrical Specifications

The accuracy specification is defined as  $\pm$  (% reading + digits) at  $23\text{ }^{\circ}\text{C} \pm 5\text{ }^{\circ}\text{C}^1$ .

Function	Range	Resolution	Accuracy (% reading + digits)	
			312	316 & 318
AC Amps <sup>2</sup> (50 ~ 500 Hz)	40.00 A	0.01 A	1.9 % $\pm$ 5	1.9 % $\pm$ 5 (50 ~ 60 Hz)
	400.0 A	0.1 A		2.5 % $\pm$ 5 (60 - 500 Hz)
1000 A	1 A			
DC Amps	40.00 A	0.01 A	-	2.5 % $\pm$ 10
	400.0 A	0.1 A		
1000 A	1 A			
AC Volts <sup>2</sup> (50 ~ 500 Hz)	400.0 V	0.1 V	1.2 % $\pm$ 5	1.5 % $\pm$ 5
	750 V	1 V		
DC Volts	400.0 V	0.1 V	0.75 % $\pm$ 2	1 % $\pm$ 2
	1000 V	1 V		
Resistance (ohms)	400.0 $\Omega$	0.1 $\Omega$	1 % $\pm$ 3	1 % $\pm$ 3
	4000 $\Omega$	1 $\Omega$		
Continuity	On at < 50 $\Omega$			
Diode Test	Up to 2 V			
Min Max	500 ms acquisition time			
Input Impedance	10 M $\Omega$			
Auto Shut-off	After 30 min $\pm$ 2 min. Disabled in Min Max. Can be disabled as a power up option (hold down the peak button)			
Auto range	Available in the following measurement functions: Volts & Ohms (Amps for 312 only)			
Overload Protection	600 Vrms per EN61010 CAT III 600 V			
<ol style="list-style-type: none"> <li>1. Temperature Coefficient: 0.1 x (specified accuracy) / <math>^{\circ}\text{C}</math> (&lt; 18 <math>^{\circ}\text{C}</math> or &gt; 28 <math>^{\circ}\text{C}</math>)</li> <li>2. True rms for ac voltage and ac amps accuracy is specified from 5 % to 100 % of range. Crest factor (50 ~ 60 Hz) is 3.0 max in the 40 A and 400 A ranges and 1.4 max in the 1000 A range (318 only).</li> <li>3. The measurement time for current above 400 A is limited to 5 minutes followed by a cooling off time of 15 minutes.</li> </ol>				

**Instrument Overview**  
**Feature Locations**

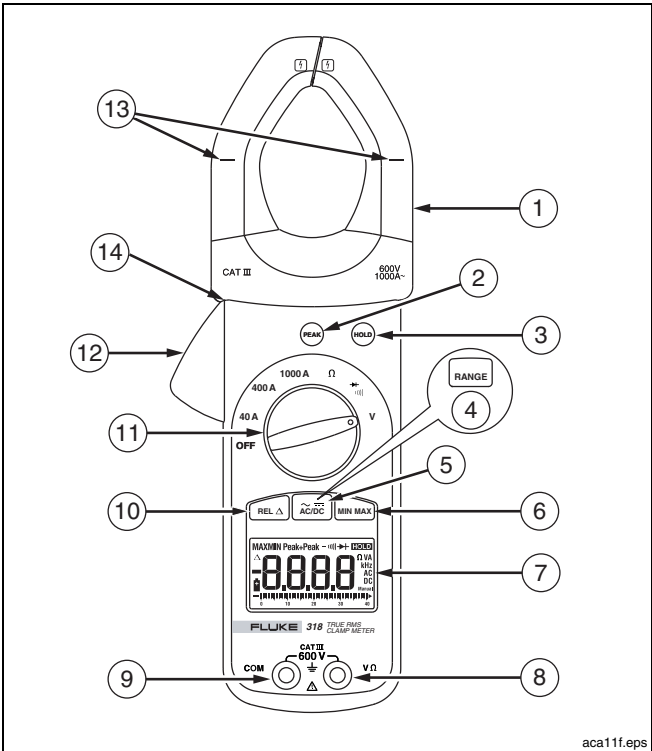

aca11f.eps

①	Current Sensing Clamp	⑧	V Ω Input Terminal
②	Peak Button	⑨	COM Terminal
③	Hold Button	⑩	REL Button (316, 318)
④	Range Button (312)	⑪	Rotary Function Switch
⑤	AC/DC Button (316, 318)	⑫	Clamp-opening Trigger
⑥	MIN MAX Button (316, 318)	⑬	Conductor Alignment Marks
⑦	LCD	⑭	Tactile Indicator

**Figure 1. Feature Locations (318 shown)**

## Symbol Definition

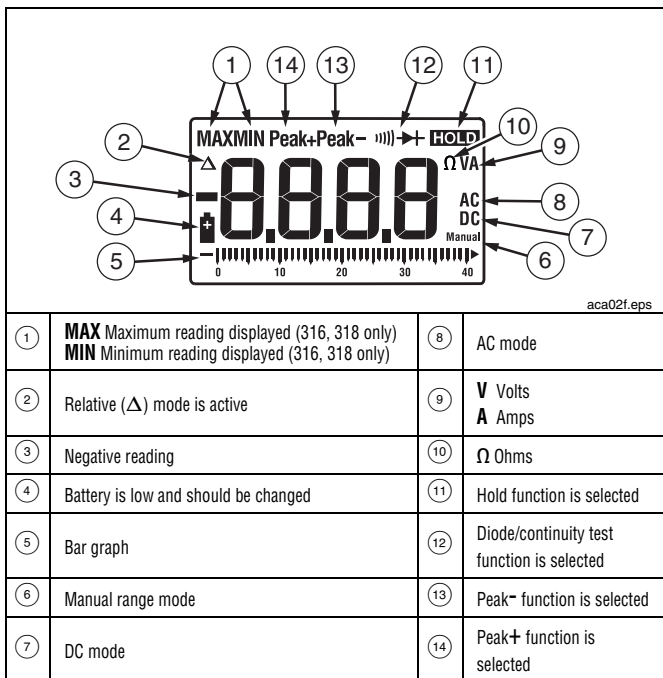



Figure 2. LCD Explanation

## Making Measurements

### **⚠**Warning

- When measuring current, center the conductor in the clamp using the alignment marks on the clamp.
- To avoid electrical shock when making current measurements, disconnect the test leads from the Meter.
- The bargraph is for reference only; it does not show the actual measured value or range. Use the main display to read the actual measured value and range.

## Measuring AC Current

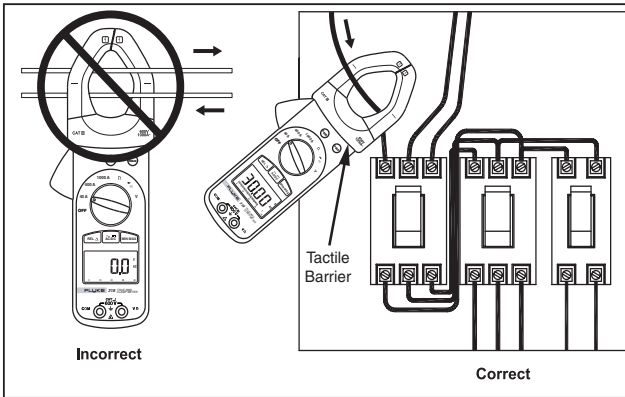

1. Turn the rotary function switch to the proper current range.
2. Press  (316, 318 only) to measure ac current if necessary.
3. Open the clamp by pressing the clamp-opening trigger and insert the conductor to be measured into the clamp.
4. Close the clamp and center the conductor using the alignment marks.
5. View the reading on the LCD.



aca13f.eps

Figure 3. Connecting the Clamp Meter (318 shown)

### **Measuring DC Current (316, 318 only)**

1. Turn the rotary function switch to the proper current range.
2. Press  to measure dc current.
3. To ensure accuracy, wait for the reading to stabilize then press  to zero the reading.
4. Open the clamp by pressing the clamp-opening trigger and insert the conductor to be measured into the clamp.
5. Close the clamp and center the conductor using the alignment marks.
6. View the reading on the LCD.

### **Measuring AC and DC Voltage**

1. Turn the rotary function switch to **V**.
2. Choose ac or dc by pressing  (316, 318 only).

When using a 312 Meter:

- turn the rotary function switch to  $\tilde{V}$  when measuring ac voltage
  - turn the rotary function switch to  $\bar{V}$  when measuring dc voltage
3. Connect the black test lead to the **COM** terminal and the red test lead to the **VΩ** terminal.
  4. Measure the voltage by touching the probes to the desired test points of the circuit.
  5. View the reading on the LCD.

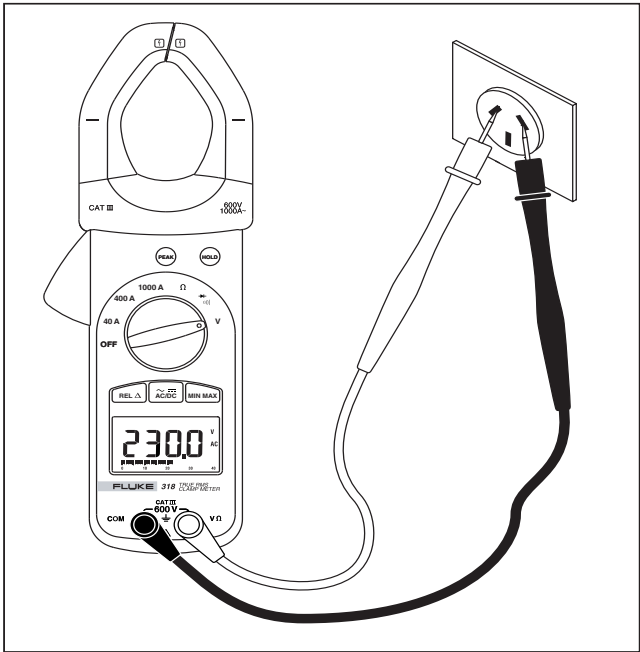

aca14f.eps

Figure 4. AC Voltage Measurement (318 shown)

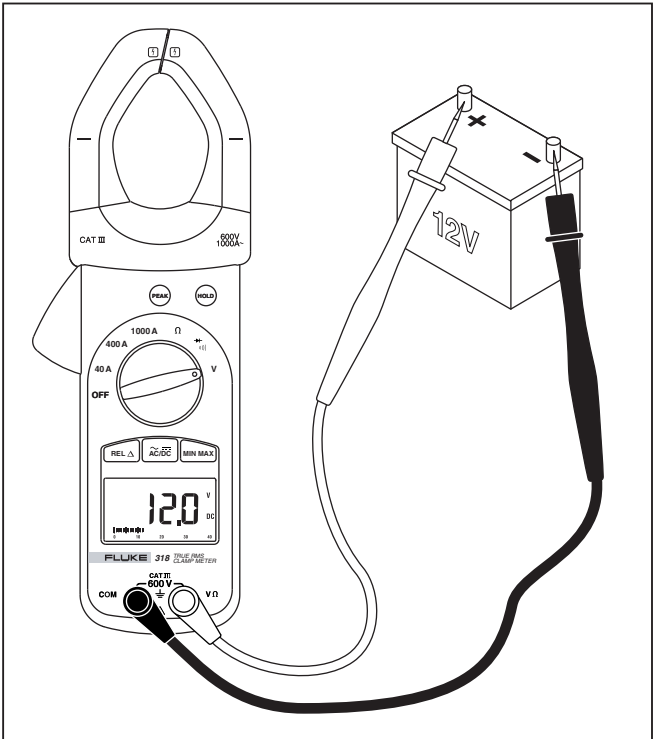

aca15f.eps

Figure 5. DC Voltage Measurement (318 shown)

## Measuring Resistance

### ⚠ Warning

To avoid electrical shock when measuring resistance in a circuit, make sure the power to the circuit is turned off and all capacitors are discharged.

1. Turn the rotary function switch to  $\Omega$ . Remove power from the circuit being tested.
2. Connect the black test lead to the **COM** terminal and the red test lead to the **V $\Omega$**  terminal.
3. Measure the resistance by touching the probes to the desired test points of the circuit.
4. View the reading on the LCD.

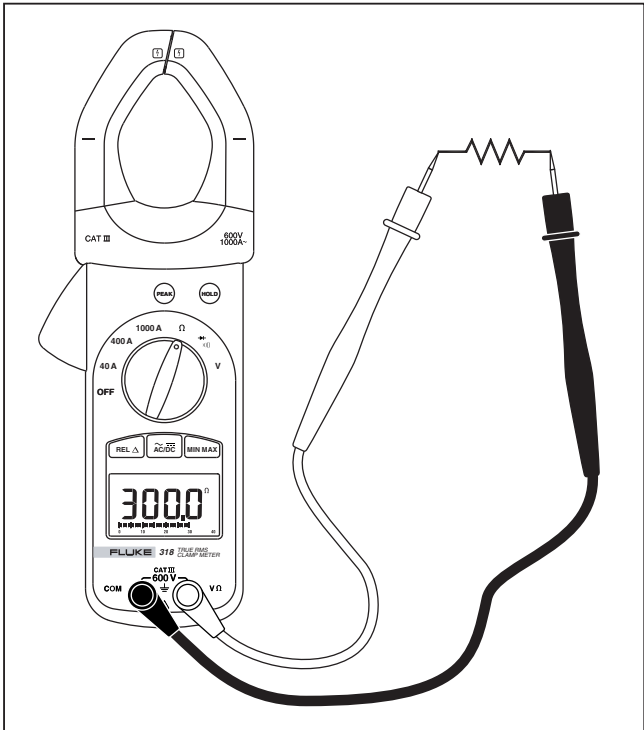

aca16f.eps

Figure 6. Measuring Resistance (318 shown)

## Testing Continuity

### ⚠ Warning

To avoid electrical shock when testing continuity in a circuit, make sure the power to the circuit is turned off and all capacitors are discharged.

1. Turn the rotary function switch to . Remove power from the circuit being tested.
2. Connect the black test lead to the **COM** terminal and the red test lead to the **VΩ** terminal.
3. Connect the probes across the circuit or component to be tested.

If the resistance is under 50 Ω, the beeper will sound continuously, designating a short circuit. If the Meter reads OL, the circuit is open.

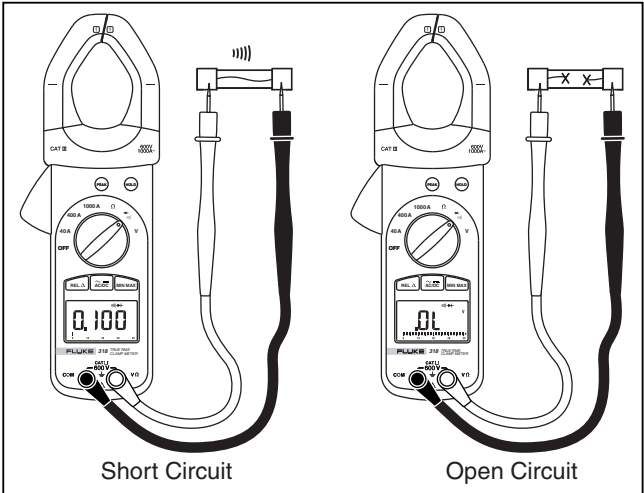

aca17f.eps

Figure 7. Measuring Continuity (318 shown)

**Diode Test****⚠ Warning**

To avoid electrical shock when testing diodes in a circuit, make sure the power to the circuit is turned off and all capacitors are discharged.

1. Turn the rotary function switch to  $\rightarrow$  (diode symbol). Remove power from the circuit being tested.
2. Connect the black test lead to the **COM** terminal and the red test lead to the **V $\Omega$**  terminal.
3. Connect the black test lead to the cathode side and the red test lead to the anode side of the diode being tested.
4. Read forward bias voltage value on the LCD.
5. If the polarity of the test leads is the reverse of the diode polarity, the LCD reading shows "OL". This can be used for distinguishing the anode side and cathode side of a diode.

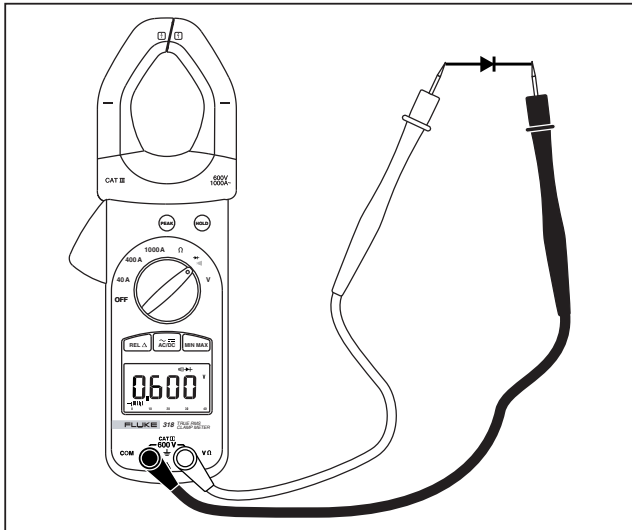

aca18f.eps

**Figure 8. Diode Test (318 shown)**

**⚠ Warning**

**Dangerous voltages may be present at the input terminals and may not be displayed.**

**Data Hold**

To hold the present reading, press the HOLD button. Press the button again to return to the live reading.

**Peak**

The Meter has a 1 ms peak feature for use with ACA, DCA (316, 318), ACV, and DCV functions. Before making a peak hold measurement, the peak feature must be calibrated as follows:





1. Press and hold the peak button for 2 seconds. The CAL indicator appears on the LCD to show that the offset has been calculated and stored by the Meter.
2. After calibration, press the peak button once to enter Peak+ mode and begin displaying Peak+ values.
3. Press the Peak button again to enter Peak- mode and begin displaying Peak- values.
4. Press the Peak button for 2 seconds to return to normal operation.

If the rotary function switch is changed following calibration, the calibration steps must be repeated before making another peak measurement.



*Note*

*The peak mode continuously updates the LCD to show maximum magnitudes. Smaller magnitudes are not displayed.*



**MIN MAX (316, 318 only)**

1. Press  once to set the Meter to MAX mode.
2. Press  again to set the Meter to MIN mode.
3. Press  again and the Meter displays the present reading while keeping track of the MAX and MIN value. This mode is also indicated by the blinking **MAXMIN** symbol on the LCD.
4. Pressing  for more than 2 seconds sets the Meter back to normal operation.

### **REL ( $\Delta$ ) (316, 318 only)**

1. Press  to set the zero to the present reading. The difference between the reference reading and subsequent readings is displayed.
2. Press  again and the Meter displays the reference reading. The blinking  $\Delta$  on the LCD also indicates this mode.
3. Press  for more than 2 seconds to return the Meter to normal operation.

### **Range (312 only)**

Press  to select the manual range mode. **Manual** shows on the LCD, and the Meter remains in the same range. To exit manual-range mode and return to the auto-range mode, press and hold  for 1 second.

### **Changing the Battery**

When the battery voltage drops below the value required for proper operation, the battery symbol () appears on the LCD.

1. Before changing the battery, switch the Meter off and disconnect the test leads.
2. Open the back cover using a screwdriver.
3. Replace the battery with a new 9 V battery.
4. Close the back cover and fasten the screws.

### **Cleaning the Meter**

Periodically clean the Meter by wiping it with a dry cloth. Do not use abrasives or solvents on this instrument.

### **Maintenance**

#### **Warning**

- To avoid electrical shock, disconnect test leads from the Meter before removing its back cover. Never use the Meter with the back cover removed.
- Repairs or servicing not covered in this manual should be performed only by qualified personnel.

#### **Caution**

- To avoid contamination or static damage, do not touch the circuit board without proper static protection.
- If the Meter is not going to be used for a long time, remove the battery. Do not store the Meter in a high temperature or a high humidity environment.