

Welcome to BOPLA City!

# INTERTEGO

## ENCLOSURE SERIES



**BOPLA**

A Phoenix Mecano Company

**Welcome to BOPLA City!**

By introducing INTERTEGO, Bopla is adding a medium-sized series to its range of desktop enclosures. Two of INTERTEGO's main features are its high-quality and innovative design.

Two heights and profile technology which allows for individual dimensions in the width and depth of the enclosure provide plenty of scope for mountings. It is also easy to convert INTERTEGO into a 19" enclosure.

All the enclosure components are designed for ease of assembly, which guarantees easy handling.

A comprehensive and innovative programme of accessories opens up new opportunities, and in addition, the enclosures can be adapted to meet customers' individual design requirements.



**Enclosure material:** Extruded profile: Al Mg Si0.5  
Die-cast lid: zinc alloy Z410  
Decor element: TPE

**Colour:** Graphite grey, similar to RAL 7024

**Ingress protection:** IP 40 / DIN EN 60529  
IP 20 / DIN EN 60529 with ventilation (ADL)

**Accessories (additional price):**

- Decor strip
- Decor elements
- Sheet metal covers with ventilation
- Sheet metal covers without ventilation
- Front panels, plug-in
- Front panels, screw-on
- Tapped strips
- Wall brackets
- Tower foot
- Handle and set-up feet on request

**External dimensions of profile:**

Model	Height	Width	Depth
IT 10...	99.85 (2 U)	variable	variable
IT 15...	144.3 (3 U)	variable	variable

**The INTERTEGO sizes – an overview:**

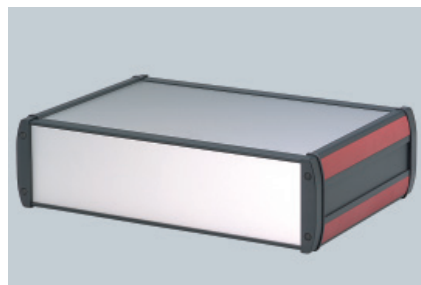

Enclosure 2U IT 10...

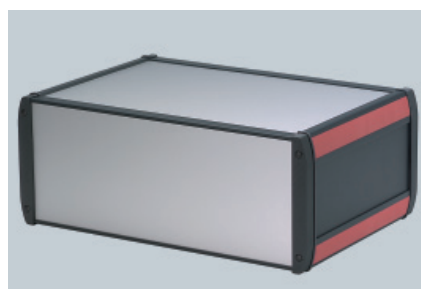

Enclosure 3U IT 15...



Handle HS ... on request



Tower foot IT 0000... T



Wall fitting IT 0000... WB

## Note

### EMC upgrade

Screening of the standard enclosure can be adapted to meet individual requirements using the optional EMC accessories. Technical details about the EMC concept can be found starting on page 14 and on the internet at [www.bopla.de](http://www.bopla.de).

### 19" rack mounting

INTERTEGO can also be used as a 19" enclosure. Details of possibilities and any necessary conversion work can be found on BOPLA's website at [www.bopla.de](http://www.bopla.de).

# INTERTEGO enclosure



INTERTEGO enclosure 2 U

Basic design



INTERTEGO enclosure 3 U

Basic design

## INTERTEGO enclosure 2 U

### Order designation

Model	Order no.	Height	U	Width	HP	Depth	CG*
IT 102520	95102520	99.85	2	250.36	42	184.4	160
IT 102525	95102525	99.85	2	250.36	42	244.4	220
IT 102530	95102530	99.85	2	250.36	42	304.4	280
IT 103520	95103520	99.85	2	357.04	63	184.4	160
IT 103525	95103525	99.85	2	357.04	63	244.4	220
IT 103530	95103530	99.85	2	357.04	63	304.4	280
IT 104520	95104520	99.85	2	463.72	84	184.4	160
IT 104525	95104525	99.85	2	463.72	84	244.4	220
IT 104530	95104530	99.85	2	463.72	84	304.4	280

### Special lengths on request

\*CG = card guide

**Scope of delivery:** 2 side profiles, graphite grey, sim. to RAL 7024  
 4 front profiles, graphite grey, sim. to RAL 7024  
 4 die-cast corners, graphite grey, sim. to RAL 7024  
 4 decor elements, graphite grey, sim. to RAL 7024  
 Fixing material

**Note:** Please order sheet metal covers, front panels, decor strips and EMC accessories separately.

## INTERTEGO enclosure 3 U

### Order designation

Model	Order no.	Height	U	Width	HP	Depth	CG*
IT 152520	95152520	144.3	3	250.36	42	184.4	160
IT 152525	95152525	144.3	3	250.36	42	244.4	220
IT 152530	95152530	144.3	3	250.36	42	304.4	280
IT 153520	95153520	144.3	3	357.04	63	184.4	160
IT 153525	95153525	144.3	3	357.04	63	244.4	220
IT 153530	95153530	144.3	3	357.04	63	304.4	280
IT 154520	95154520	144.3	3	463.72	84	184.4	160
IT 154525	95154525	144.3	3	463.72	84	244.4	220
IT 154530	95154530	144.3	3	463.72	84	304.4	280

### Special lengths on request

\*CG = card guide

**Scope of delivery:** 2 side profiles, graphite grey, sim. to RAL 7024  
 4 front profiles, graphite grey, sim. to RAL 7024  
 4 die-cast corners, graphite grey, sim. to RAL 7024  
 4 decor elements, graphite grey, sim. to RAL 7024  
 Fixing material

**Note:** Please order sheet metal covers, front panels, decor strips and EMC accessories separately.





# INTERTEGO accessories

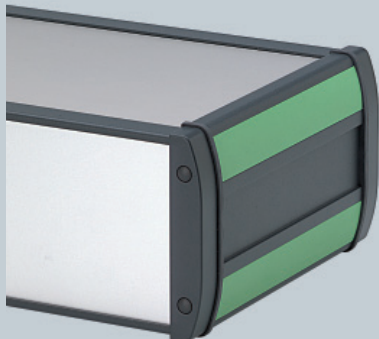

### Decor strips

Decor strips give an enclosure an individual look. They are available in grey, green, blue, red and orange, and are fitted in the side system groove. Of course, printed foil strips to meet customers' individual requirements are also available on request. The decor strips also function as screw covering strips for the wall fittings.

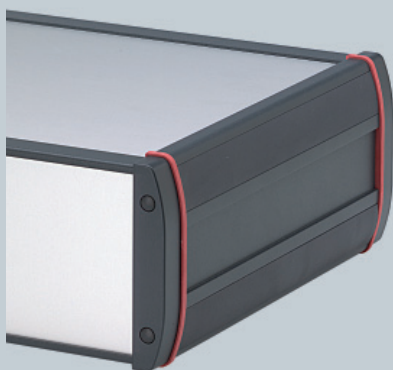

### Decor elements

The decor elements are an alternative to the grey decor elements supplied as part of the standard scope of delivery. Coloured elements can adapt the enclosure design even more closely to the customer's required design.

### Decor strips

#### Order designation

Model	Order no.	For enclosure	Colour	Strip length
IT 000020 DS-blue	95001520	IT ....20	blue	148.4 mm
IT 000020 DS-red	95001220	IT ....20	red	148.4 mm
IT 000020 DS-green	95001320	IT ....20	green	148.4 mm
IT 000020 DS-orange	95001420	IT ....20	orange	148.4 mm
IT 000020 DS-dark grey	95001120	IT ....20	dark grey	148.4 mm
IT 000025 DS-blue	95001525	IT ....25	blue	208.4 mm
IT 000025 DS-red	95001225	IT ....25	red	208.4 mm
IT 000025 DS-green	95001325	IT ....25	green	208.4 mm
IT 000025 DS-orange	95001425	IT ....25	orange	208.4 mm
IT 000025 DS-dark grey	95001125	IT ....25	dark grey	208.4 mm
IT 000030 DS-blue	95001530	IT ....30	blue	268.4 mm
IT 000030 DS-red	95001230	IT ....30	red	268.4 mm
IT 000030 DS-green	95001330	IT ....30	green	268.4 mm
IT 000030 DS-orange	95001430	IT ....30	orange	268.4 mm
IT 000030 DS-dark grey	95001130	IT ....30	dark grey	268.4 mm

### Special lengths on request

Scope of delivery: 20 decor strips (for 5 enclosures)

### Decor elements

#### Order designation

Model	Order no.	For enclosure U	Colour
IT 100000 DE-red	95102200	IT 10.... 2	red
IT 100000 DE-green	95102300	IT 10.... 2	green
IT 100000 DE-orange	95102400	IT 10.... 2	orange
IT 100000 DE-blue	95102500	IT 10.... 2	blue
IT 150000 DE-red	95152200	IT 15.... 3	red
IT 150000 DE-green	95152300	IT 15.... 3	green
IT 150000 DE-orange	95152400	IT 15.... 3	orange
IT 150000 DE-blue	95152500	IT 15.... 3	blue

### Special lengths on request

Scope of delivery: 20 decor elements (for 5 enclosures)

IT 0000... DS-...

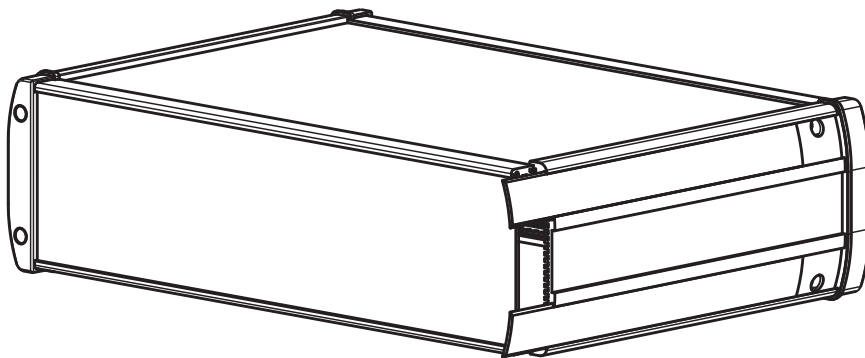

The decor strips can be fitted at a later date without any need to disassemble the corners

Model	L	for enclosures
IT 000020 DS	148.4	IT ... 20
IT 000025 DS	208.4	IT ... 25
IT 000030 DS	268.4	IT ... 30

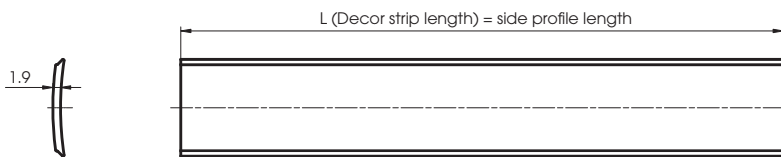

Z-2803083

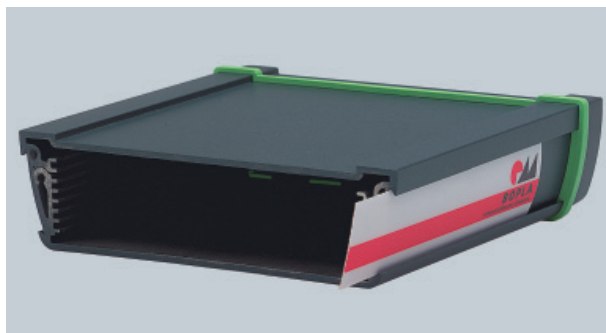

Customer-specific printed foil marking strips on request.



# INTERTEGO accessories

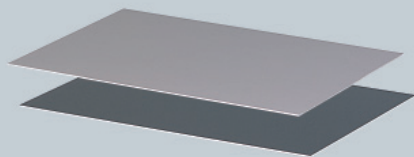

Sheet metal covers, closed

## Sheet metal covers, closed

### Order designation

Model	Order no.	For enclosures	Colour
IT 002520 AD-7024	95012520	IT ..2520	Graph. grey, sim. to RAL 7024
IT 002525 AD-7024	95012525	IT ..2525	Graph. grey, sim. to RAL 7024
IT 002530 AD-7024	95012530	IT ..2530	Graph. grey, sim. to RAL 7024
IT 003520 AD-7024	95013520	IT ..3520	Graph. grey, sim. to RAL 7024
IT 003525 AD-7024	95013525	IT ..3525	Graph. grey, sim. to RAL 7024
IT 003530 AD-7024	95013530	IT ..3530	Graph. grey, sim. to RAL 7024
IT 004520 AD-7024	95014520	IT ..4520	Graph. grey, sim. to RAL 7024
IT 004525 AD-7024	95014525	IT ..4525	Graph. grey, sim. to RAL 7024
IT 004530 AD-7024	95014530	IT ..4530	Graph. grey, sim. to RAL 7024
IT 002520 AD-EQ	95022520	IT ..2520	Anodised
IT 002525 AD-EQ	95022525	IT ..2525	Anodised
IT 002530 AD-EQ	95022530	IT ..2530	Anodised
IT 003520 AD-EQ	95023520	IT ..3520	Anodised
IT 003525 AD-EQ	95023525	IT ..3525	Anodised
IT 003530 AD-EQ	95023530	IT ..3530	Anodised
IT 004520 AD-EQ	95024520	IT ..4520	Anodised
IT 004525 AD-EQ	95024525	IT ..4525	Anodised
IT 004530 AD-EQ	95024530	IT ..4530	Anodised

Scope of delivery: 1 sheet metal cover, aluminium 1 mm

## Sheet metal covers, with ventilation

### Order designation

Model	Order no.	For enclosures	Colour
IT 002520 ADL-7024	95032520	IT ..2520	Graph. grey, sim. to RAL 7024
IT 002525 ADL-7024	95032525	IT ..2525	Graph. grey, sim. to RAL 7024
IT 002530 ADL-7024	95032530	IT ..2530	Graph. grey, sim. to RAL 7024
IT 003520 ADL-7024	95033520	IT ..3520	Graph. grey, sim. to RAL 7024
IT 003525 ADL-7024	95033525	IT ..3525	Graph. grey, sim. to RAL 7024
IT 003530 ADL-7024	95033530	IT ..3530	Graph. grey, sim. to RAL 7024
IT 004520 ADL-7024	95034520	IT ..4520	Graph. grey, sim. to RAL 7024
IT 004525 ADL-7024	95034525	IT ..4525	Graph. grey, sim. to RAL 7024
IT 004530 ADL-7024	95034530	IT ..4530	Graph. grey, sim. to RAL 7024
IT 002520 ADL-EQ	95042520	IT ..2520	Anodised
IT 002525 ADL-EQ	95042525	IT ..2525	Anodised
IT 002530 ADL-EQ	95042530	IT ..2530	Anodised
IT 003520 ADL-EQ	95043520	IT ..3520	Anodised
IT 003525 ADL-EQ	95043525	IT ..3525	Anodised
IT 003530 ADL-EQ	95043530	IT ..3530	Anodised
IT 004520 ADL-EQ	95044520	IT ..4520	Anodised
IT 004525 ADL-EQ	95044525	IT ..4525	Anodised
IT 004530 ADL-EQ	95044530	IT ..4530	Anodised

Scope of delivery: 1 sheet metal cover, aluminium 1 mm

### IT... AD-...

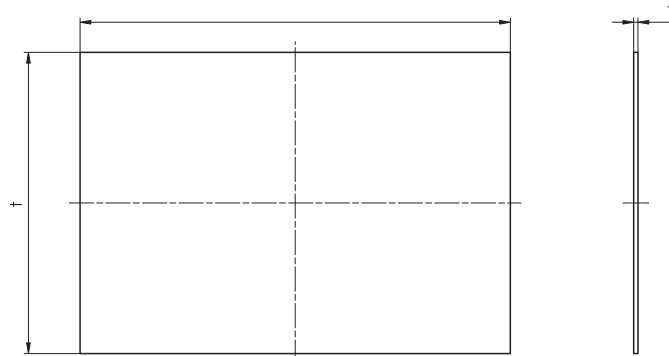

Model	l	t	for enclosures
IT 002520 AD-....	220.94	153.1	IT .. 2520
IT 002525 AD-....	220.94	213.1	IT .. 2525
IT 002530 AD-....	220.94	273.1	IT .. 2530
IT 003520 AD-....	327.62	153.1	IT .. 3520
IT 003525 AD-....	327.62	213.1	IT .. 3525
IT 003530 AD-....	327.62	273.1	IT .. 3530
IT 004520 AD-....	434.3	153.1	IT .. 4520
IT 004525 AD-....	434.3	213.1	IT .. 4525
IT 004530 AD-....	434.3	273.1	IT .. 4530

l = front profile length + 2.5mm  
t = side profile length +4.74mm

Z-2803086

### IT... ADL-...

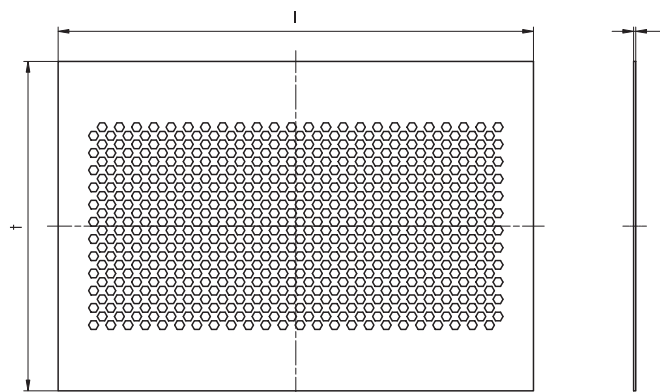

Model	l	t	for enclosures
IT 002520 ADL-....	220.94	153.1	IT .. 2520
IT 002525 ADL-....	220.94	213.1	IT .. 2525
IT 002530 ADL-....	220.94	273.1	IT .. 2530
IT 003520 ADL-....	327.62	153.1	IT .. 3520
IT 003525 ADL-....	327.62	213.1	IT .. 3525
IT 003530 ADL-....	327.62	273.1	IT .. 3530
IT 004520 ADL-....	434.3	153.1	IT .. 4520
IT 004525 ADL-....	434.3	213.1	IT .. 4525
IT 004530 ADL-....	434.3	273.1	IT .. 4530

l = front profile length + 2.5mm  
t = side profile length +4.74mm

Z-2803087



# INTERTEGO accessories



Front panels, plug-in

## Front panels, plug-in

### Order designation

Model	Order no.	Height	U	Width	HP	For enclosures
IT 102500 FP	95104025	87.65	2	220.66	42	IT 1025..
IT 103500 FP	95104035	87.65	2	327.34	63	IT 1035..
IT 104500 FP	95104045	87.65	2	434.02	84	IT 1045..
IT 152500 FP	95154025	132.1	3	220.66	42	IT 1525..
IT 153500 FP	95154035	132.1	3	327.34	63	IT 1535..
IT 154500 FP	95154045	132.1	3	434.02	84	IT 1545..

Special widths on request.

Scope of delivery:

1 front panel,  
aluminium 2 mm, anodised



Front panels, screw-on

## Front panels, screw-on

Model	Order no.	Height	U	HP	For enclosures
TF/M 242	86842023	84.0	2	42	IT 1025..
TF/M 263	86863023	84.0	2	63	IT 1035..
TF/M 284	86884023	84.5	2	84	IT 1045..
TF/M 342	86842033	128.4	3	42	IT 1525..
TF/M 363	86863033	128.4	3	63	IT 1535..
TF/M 384	86884033	128.4	3	84	IT 1545..

Special widths on request.

Scope of delivery:

1 front panel, screw-on,  
aluminium 2.5 mm, anodised

Note: Please order tapped strips, neck collar screws and screwholders separately:

Model	Order no.	Article description	Qty.	Material
ISH/M 19	86080510	Plastic screwholder	20 pcs.	PA 6 grey
ISHM/M 19	86080500	Metal screwholder	20 pcs.	Steel, stainless
BFS/M 1600	86000160	Neck collar screws SHR Z M2, 5x12.3x6.5-SP (plus/minus screw)	20 pcs.	St. nickel-plated
BFS/M 1700	86000170	Neck collar screws SHR Z M2, 5x12.3x6.5-SP (torx screw)	20 pcs.	St. nickel-plated
BFS/M 2200	86000220	Neck collar screws SHR Z M2, 5x12.3x6.5-SP (knurled screw)	20 pcs.	St. nickel-plated
IRS 19	54700420	Neck collar screws SHR Z M2, 5x11.3x6.3-SP (knurled screw with slit)	20 pcs.	St. nickel-plated

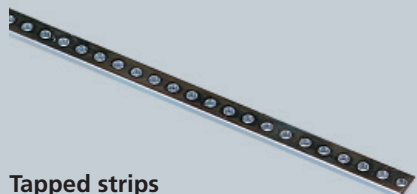

Tapped strips

Tapped strip GS 000..-I is used in the assembly of the screw-on front panel. Tapped strip GS 000..-II fits into the groove on the front profile (see illus. on page 11) and secures installed devices.

## Tapped strips

### Order designation

Model	Order no.	HP	For enclosures
GS 00042-I	54000421	42	IT 1025..
GS 00063-I	54000631	63	IT 1035..
GS 00084-I	54000841	84	IT 1045..
GS 00042-II	54000422	42	IT 1525..
GS 00063-II	54000632	63	IT 1535..
GS 00084-II	54000842	84	IT 1545..

Special lengths on request.

Scope of delivery:

2 tapped strips  
Material: Steel, galvanised



**IT... FP**

Model	I	h	for enclosures
IT 102500 FP	220.66	87.65	IT 1025 ..
IT 103500 FP	327.34	87.65	IT 1035 ..
IT 104500 FP	434.02	87.65	IT 1045 ..
IT 152500 FP	220.66	132.1	IT 1525 ..
IT 153500 FP	327.34	132.1	IT 1535 ..
IT 154500 FP	434.02	132.1	IT 1545 ..

I = front profile length + 2.22mm

Z-2803088

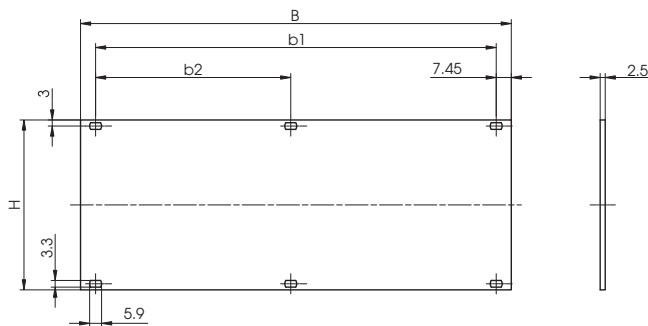

**TF/M...**

Model	H	B	b1	b2	for enclosures
TF/M 242	84	213	198.1	96.5	IT 1025 ..
TF/M 263	84	319.7	304.8	147.3	IT 1035 ..
TF/M 284	84	426.4	411.5	208.3	IT 1045 ..
TF/M 342	128.4	213	198.1	96.5	IT 1525 ..
TF/M 363	128.4	319.7	304.8	147.3	IT 1535 ..
TF/M 384	128.4	426.4	411.5	208.3	IT 1545 ..

Z-2803089

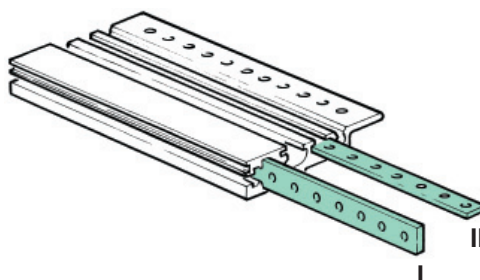

**GS...-**



# INTERTEGO accessories

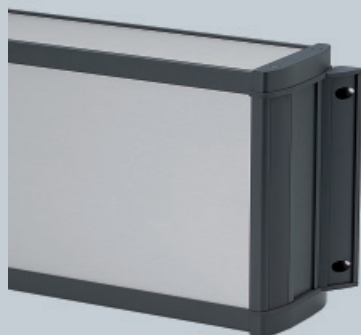

## Wall fitting

The wall fitting is supplied as standard with the side covers. It is designed so that the screw holes can be covered with the standard decor strips.



## Tower foot

The tower foot can be used to stand the enclosure upright.

### Wall fitting

#### Order designation

Model	Order no.	For enclosures	Wall bracket length	Colour
IT 000020 WB	95005020	IT ....20	148.4	Graphite grey, sim. to RAL 7024
IT 000025 WB	95005025	IT ....25	208.4	Graphite grey, sim. to RAL 7024
IT 000030 WB	95005030	IT ....30	268.4	Graphite grey, sim. to RAL 7024

Special lengths on request.      Scope of delivery:      2 wall fittings, 4 covers, dark grey

Note: Coloured covers can also be used:

#### Order designation

Model	Order no.	Comment
AS 0030 AK-WB-red	94785000	Covers for wall fitting, red
AS 0030 AK-WB-green	94783000	Covers for wall fitting, green
AS 0030 AK-WB-orange	94786000	Covers for wall fitting, orange
AS 0030 AK-WB-blue	94784000	Covers for wall fitting, blue

Scope of delivery:      4 covers

### Tower foot

#### Order designation

Model	Order no.	For enclosures	Tower foot length	Colour
IT 000020 T	95006020	IT ....20	148.4	Graphite grey, sim. to RAL 7024
IT 000025 T	95006025	IT ....25	208.4	Graphite grey, sim. to RAL 7024
IT 000030 T	95006030	IT ....30	268.4	Graphite grey, sim. to RAL 7024

Special lengths on request.      Scope of delivery:      2 tower feet, 4 rubber feet

### IT...WB

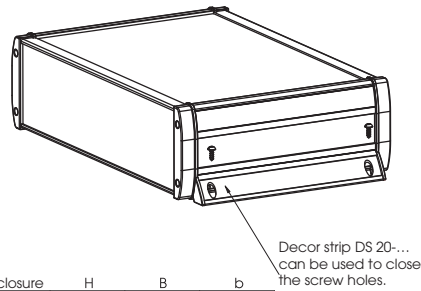
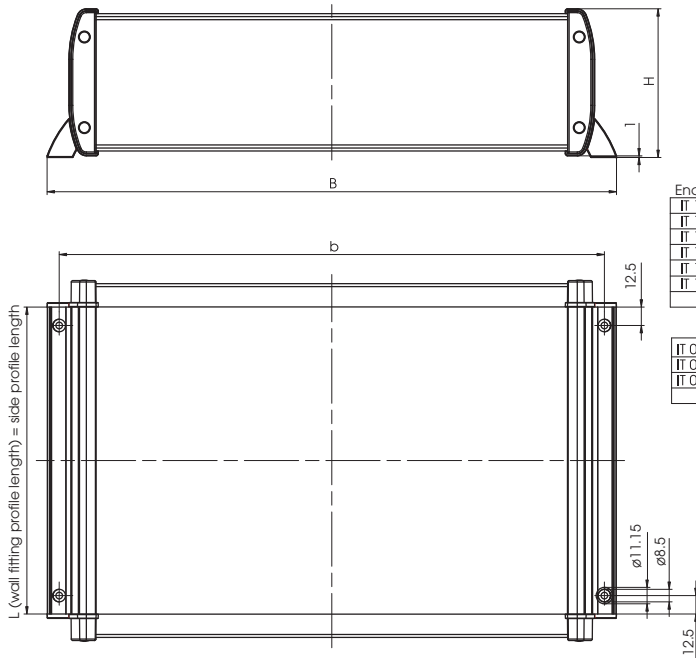

Enclosure	H	B	b
IT 1025 ..	101	279.98	263.53
IT 1030 ..	101	386.66	370.21
IT 1035 ..	101	493.34	476.89
IT 1525 ..	145.45	279.98	263.53
IT 1530 ..	145.45	386.66	370.21
IT 1535 ..	145.45	493.34	476.89

Model	L	for enclosure
IT 000020 WB	148.4	IT .... 20
IT 000025 WB	208.4	IT .... 25
IT 000030 WB	268.4	IT .... 30

Z-2803084

### IT...T

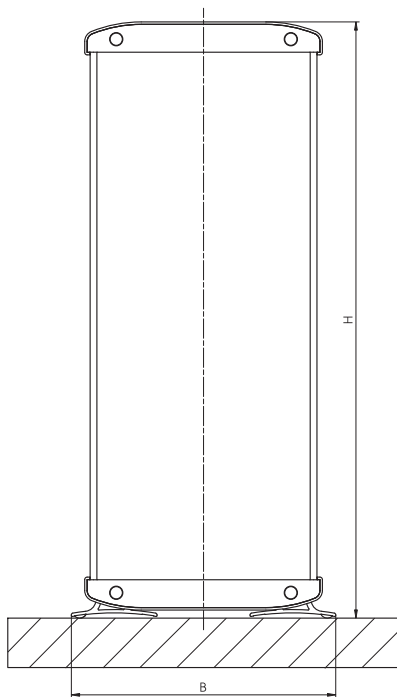

Enclosure	H	B
IT 1025..	255.25	116.05
IT 1035..	361.93	116.05
IT 1045..	468.61	116.05
IT 1525..	255.25	160.5
IT 1535..	361.93	160.5
IT 1545..	468.61	160.5

Model	L	for enclosure
IT 000020 T	148.4	IT .... 20
IT 000025 T	208.4	IT .... 25
IT 000030 T	268.4	IT .... 30

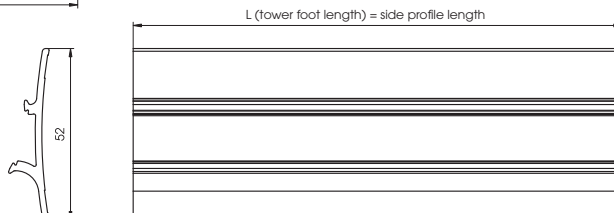
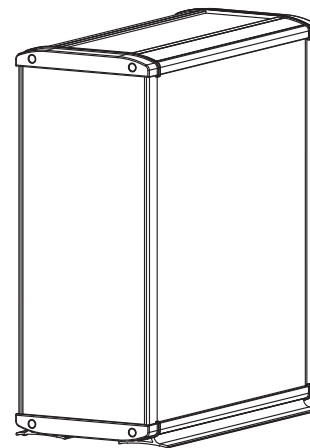

Z-2803085



# INTERTEGO EMC upgrade

## EMC upgrade sets

Model	Order no.	Article description	Scope of delivery
IT-EMC 1	95112000	EMC textile seal	8 pcs., length 425 mm
IT-EMC 2	95110000	EMC corner set 2 U	20 pcs. EMC corner springs
IT-EMC 3	95160000	EMC corner set 3 U	20 pcs. EMC corner springs
EMC spring FP/M 42 HP	86001142	Front profile EMC spring	10 pcs. length 202.9 mm
EMC spring FP/M 63 HP	86001163	Front profile EMC spring	10 pcs., length 304.8 mm
EMC spring FP/M 84 HP	86001184	Front profile EMC spring	10 pcs., length 416.3 mm
EMC cord	on request	Assembly by BOPLA	



EMC corner set IT-EMC 2/3

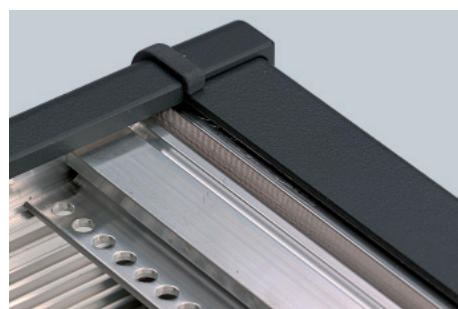

EMC textile seal IT-EMC 1

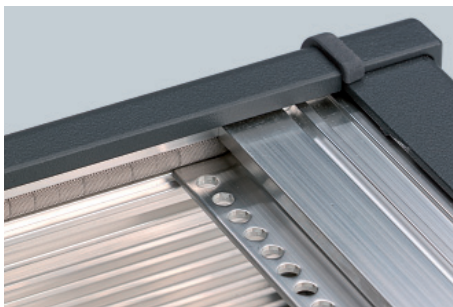

EMC textile seal IT-EMC 1

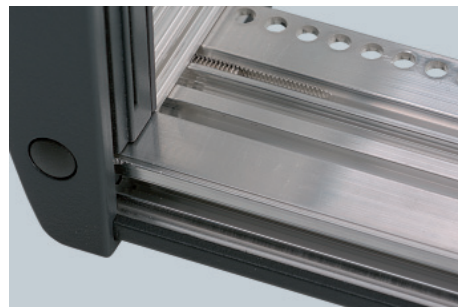

EMC spring - FP/M...HP

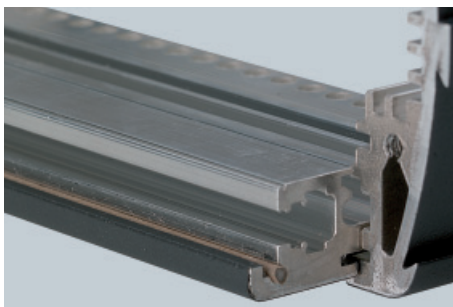

EMC cord

### EMC sheet metal covers, closed

#### Order designation

Model	Order no.	For enclosures	Colour / type
IT 002520 AD-7024-EMC	95052520	IT ..2520	Graphite grey, sim. to RAL 7024
IT 002525 AD-7024-EMC	95052525	IT ..2525	Graphite grey, sim. to RAL 7024
IT 002530 AD-7024-EMC	95052530	IT ..2530	Graphite grey, sim. to RAL 7024
IT 003520 AD-7024-EMC	95053520	IT ..3520	Graphite grey, sim. to RAL 7024
IT 003525 AD-7024-EMC	95053525	IT ..3525	Graphite grey, sim. to RAL 7024
IT 003530 AD-7024-EMC	95053530	IT ..3530	Graphite grey, sim. to RAL 7024
IT 004520 AD-7024-EMC	95054520	IT ..4520	Graphite grey, sim. to RAL 7024
IT 004525 AD-7024-EMC	95054525	IT ..4525	Graphite grey, sim. to RAL 7024
IT 004530 AD-7024-EMC	95054530	IT ..4530	Graphite grey, sim. to RAL 7024

### EMC sheet metal covers, with ventilation

#### Order designation

Model	Order no.	For enclosures	Colour / type
IT 002520 ADL-7024-EMC	95062520	IT ..2520	Graphite grey, sim. to RAL 7024
IT 002525 ADL-7024-EMC	95062525	IT ..2525	Graphite grey, sim. to RAL 7024
IT 002530 ADL-7024-EMC	95062530	IT ..2530	Graphite grey, sim. to RAL 7024
IT 003520 ADL-7024-EMC	95063520	IT ..3520	Graphite grey, sim. to RAL 7024
IT 003525 ADL-7024-EMC	95063525	IT ..3525	Graphite grey, sim. to RAL 7024
IT 003530 ADL-7024-EMC	95063530	IT ..3530	Graphite grey, sim. to RAL 7024
IT 004520 ADL-7024-EMC	95064520	IT ..4520	Graphite grey, sim. to RAL 7024
IT 004525 ADL-7024-EMC	95064525	IT ..4525	Graphite grey, sim. to RAL 7024
IT 004530 ADL-7024-EMC	95064530	IT ..4530	Graphite grey, sim. to RAL 7024

Scope of delivery: 1 sheet metal cover, EMC type, aluminium 1 mm

### EMC front panels, plug-in

#### Order designation

Model	Order no.	Height	U	Width	HP	For enclosures
IT 102500 FP-EMC	95114025	87.65	2	220.66	42	IT 1025..
IT 103500 FP-EMC	95114035	87.65	2	327.34	63	IT 1035..
IT 104500 FP-EMC	95114045	87.65	2	434.02	84	IT 1045..
IT 152500 FP-EMC	95164025	132.1	3	220.66	42	IT 1525..
IT 153500 FP-EMC	95164035	132.1	3	327.34	63	IT 1535..
IT 154500 FP-EMC	95164045	132.1	3	434.02	84	IT 1545..

#### Special widths on request

Scope of delivery: 1 EMC front panel, aluminium 2 mm,  
front: anodised, rear: colour passivated

### EMC front panels, screw-on

#### Order designation

Model	Order no.	Height	U	HP	For enclosures
TF/M 242-EMC	86842024	84.0	2	42	IT 1025..
TF/M 263-EMC	86863024	84.0	2	63	IT 1035..
TF/M 284-EMC	86884024	84.0	2	84	IT 1045..
TF/M 342-EMC	86842034	128.4	3	42	IT 1525..
TF/M 363-EMC	86863034	128.4	3	63	IT 1535..
TF/M 384-EMC	86884034	128.4	3	84	IT 1545..

#### Special widths on request

Scope of delivery: 1 EMC front panel, screw on, aluminium 2 mm,  
front: anodised, rear: colour passivated

Note: Please order neck collar screws and screwholders separately, see page 10.



EMC sheet metal covers

The drawing is shown on page 9.



EMC front panels, plug-in

The drawing is shown on page 11.

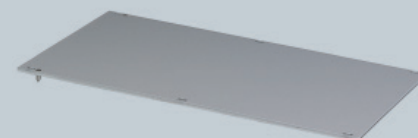

EMC front panels, screw-on

The drawing is shown on page 11.

**Welcome to BOPLA City!**

*"Put your faith in our high level of specialist knowledge and our many years of experience"*



## BOPLA – your partner from A to Z

As manufacturers of plastic and aluminium enclosures, we offer you a high level of specialist knowledge coupled with many years of successful experience. We not only produce empty enclosures and standardised membrane keypads – you can also rely on our comprehensive technical support when designing and developing new products.

We are one of the world's leading system suppliers for enclosure technology, so you expect tailor-made complete solutions for the reliable protection of your electronic articles.

Take advantage of our many years of experience in the fields of designing, manufacturing and processing of enclosure systems, membrane keypads, electronic assemblies and complete system solutions.

So that you can put into practice your individual ideas and requirements, we make available to you the expertise of our BOPLA development teams with all their know-how and technical abilities.

Whether you require mechanical processing, printing, the assembly of enclosure parts or other electro-mechanical articles, terminal assembly, pre-wiring or the assembly of membrane keypads, by working together with us you can create solutions and systems which meet your individual needs.

You will find additional information on our website, where our 3D tools let you experience our wide range of enclosures:

[www.bopla.de](http://www.bopla.de)

### Take advantage of our competences:

- Design
- Production and processing of enclosure systems
- Membrane keypads
- Electronic assemblies
- System solutions – complete solutions from a single source!

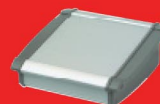

Enclosures



Keypads



Electronics



Service



Bopla Gehäuse Systeme GmbH Borsigstraße 17-25 32257 Bünde Germany  
Tel.: +49(0)52 23/969-0 Fax: +49(0)52 23/969-100  
info@bopla.de www.bopla.de

Rose+Bopla Enclosures 7330 Executive Way, Frederick, MD 21704 USA  
Phone: 1-301-696-9800 Fax: 1-301-696-9494  
RBinfo@pm-usa.com www.rose-bopla.com