

KSC-ST Series Sound Tunable Tact Switch

Features/Benefits

- Positive tactile feeling
- Range of 2 sound intensity
- J or G terminations
- Tape & reel
- IP 67

Typical Applications

- Automotive
- Industrial electronics
- Keyboards
- Medical equipment



Specification

FUNCTION: momentary action
CONTACT ARRANGEMENT: 1 make contact = SPST, N.O.
TERMINALS: J bend & Gullwing type for SMT

Mechanical

Type	Sound Intensity *	Operating Force	Travel (mm)
KSC441J ST1 LFS	>50dBA	3.4 ± 1N	0.7 ± 0.25
KSC441J ST2 LFS	<30dBA	3.4 ± 1N	0.35 ± 0.20
KSC461J ST1 LFS	>50dBA	4.5/8.0N	1.0 ± 0.3
KSC461J ST2 LFS	<30dBA	4.5/8.0N	0.5 ± 0.2

OPERATING LIFE:

300,000 cycles for KSC44 and KSC461JST2LFS
100,000 cycles for KSC461JST1LFS

- (*) Sound intensity is given as a reference, switch isolated, outside any additive part such as PCB, button, etc. The sound intensity after product integration may change according to the surrounding parts. For other features, please refer to the KSC Series data sheets.

Electrical

	Silver	Gold
MAXIMUM POWER:	1 VA	0.2 VA
MAXIMUM VOLTAGE:	32 VDC	32 VDC
MINIMUM VOLTAGE:	20 mV	20 mV
MAXIMUM CURRENT:	50 mA	10 mA
MINIMUM CURRENT:	1 mA	1 mA

DIELECTRIC STRENGTH (50 Hz, 1 min.): 250 V
CONTACT RESISTANCE: < 100 mΩ
INSULATION RESISTANCE (100 V): > 10⁹ Ω
BOUNCE TIME: < 1 ms

Environmental

	Silver	Gold
OPERATING TEMPERATURE:	-40°C to 85°C	-40°C to 125°C
STORAGE TEMPERATURE:	-55°C to 85°C	-55°C to 125°C

Process

SOLDERING: Depending on the application, this component is suited to the following methods:

- Cleaning according to typical washing processes.
- Infrared Reflow Soldering in accordance with IEC 61760-1.

Packaging

In reels of 1,000 pieces.
Dimensions of reels according to EIA RS481 or IEC 2863.
External diameter 330 mm ± 2 mm.

NOTE: Specifications listed above are for switches with standard options.
For information on specific and custom switches, consult Customer Service Center.

How To Order

Our easy build-a-switch concept allows you to mix and match options to create the switch you need. To order, select desired option from each category and place it in the appropriate box.

For any part number different from those listed above, please consult your local representative.

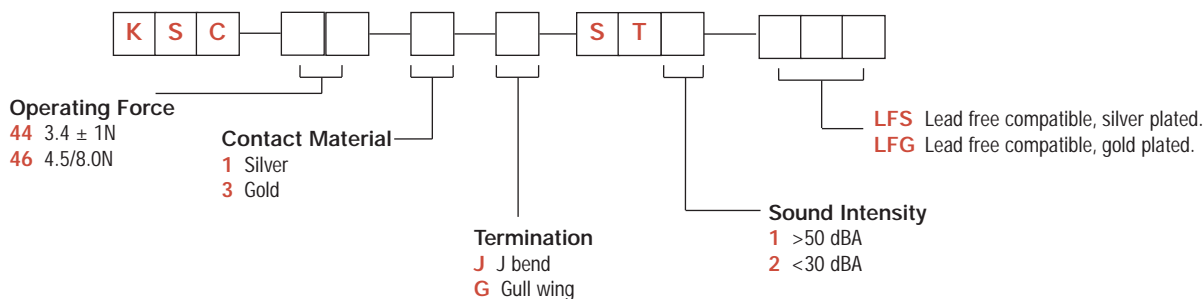

KSC-ST Series Sound Tunable Tact Switch

ACTUATOR

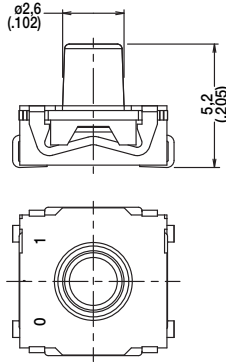

CONTACT MATERIAL

OPTION CODE	MATERIAL
1	SILVER
3	GOLD

TERMINATION

J J BEND

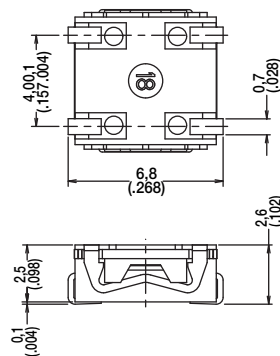

G GULLWING

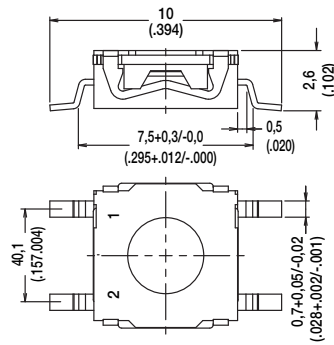

PAD LAYOUT

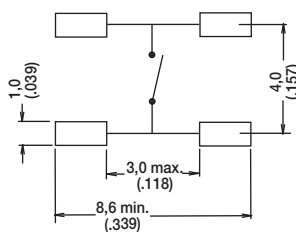

PAD LAYOUT

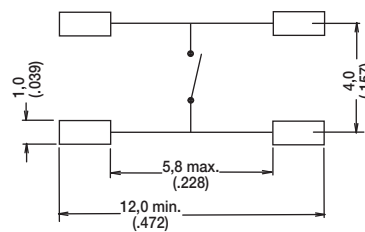

Dimensions shown in: mm (inch)
Specifications and dimensions subject to change

KSC-ST Series Sound Tunable Tact Switch

SOUND INTENSITY



OPTION CODE	SOUND INTENSITY
ST1	>50 dBA
ST2	<30 dBA

B

Tactile Switches

TAPE & REEL

FOR KSC4 FOR G TERMINATION

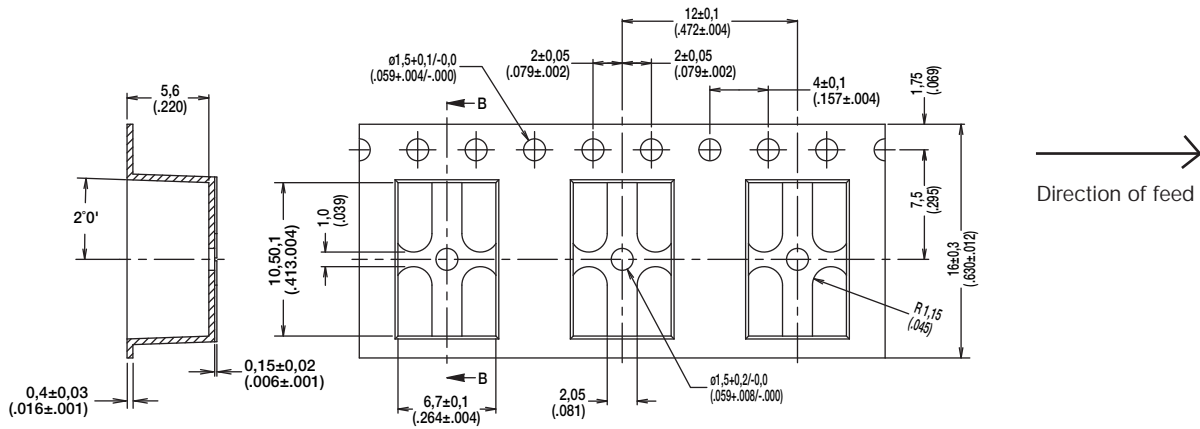

FOR KSC4 FOR J TERMINATION

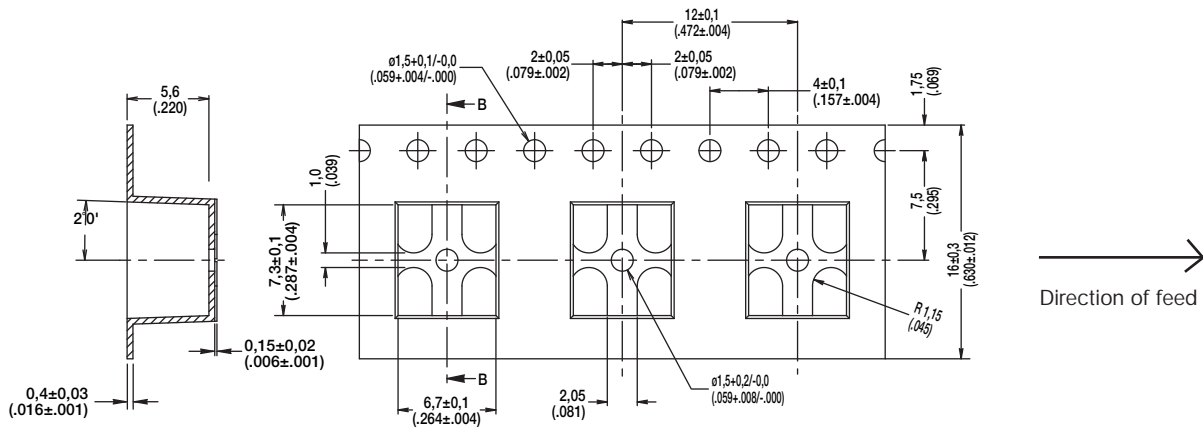

Dimensions shown in: mm (inch)
Specifications and dimensions subject to change

www.ck-components.com