

## Double valve connector cable - SAC-10,0/0,2-116/2XB-1L-Z - 1458279

Please be informed that the data shown in this PDF Document is generated from our Online Catalog. Please find the complete data in the user's documentation. Our General Terms of Use for Downloads are valid (<http://phoenixcontact.com/download>)



Double valve connector cable, 4-position, PUR/PVC, Black RAL 9005, free cable end, on Valve connector B (10 mm), with 1 LED, connected with Z diode and Valve connector B (10 mm), with 1 LED, connected with Z diode, Cable length: 10 m, Valve connector distance: 0.2 m

### Why buy this product

- ✓ Easy and safe: 100% electrically tested plug-in components
- ✓ Robust valve connector with Zener diode as protective circuit
- ✓ Efficient: control valves with two connections via a single connecting cable
- ✓ Convenient: increased machine availability thanks to quick and easy diagnostics



### Key commercial data

Packing unit	1 pc
GTIN	 4 046356 638715
Weight per Piece (excluding packing)	670.2 g
Custom tariff number	85444290
Country of origin	Poland
Note	Made to Order (non-returnable)

### Technical data

#### Dimensions

Length of cable	10 m
Valve connector distance	0.2 m

#### Ambient conditions

Ambient temperature (operation)	-25 °C ... 85 °C (valve plug)
Degree of protection	IP65
	IP67

#### General

Rated current at 40°C	4 A
Rated voltage	24 V AC/DC
Number of positions	4

# Double valve connector cable - SAC-10,0/0,2-116/2XB-1L-Z - 1458279

## Technical data

### General

Contact resistance	≤ 5 mΩ
Insulation resistance	≥ 100 MΩ
Standards/regulations	Valve connector EN 175301-803
Status display	1 LED
Protective circuit/component	Z diode
Surge voltage category	II
Pollution degree	3
Insertion/withdrawal cycles	50
Torque	0.6 Nm (Valve connector)

### Material

Inflammability class according to UL 94	HB
Valve plug contact material	CuSn
Valve plug contact surface material	Sn
Valve plug contact insert material	PA 66
Material housing valve plug	TPU
Sealing material	TPU (Seal molded)

### Cable

Cable type	PUR/PVC, 0.75 mm <sup>2</sup> , black
Cable type (abbreviation)	116
Cable abbreviation	LiYY11Y-HF
UL AWM style	20549
Conductor cross section	4x 0.75 mm <sup>2</sup>
AWG signal line	18
Conductor structure signal line	24x 0.20 mm
Core diameter including insulation	1.7 mm ±0.05 mm
Wire colors	Black 1, black 2, black 3, green/yellow
Overall twist	4 wires, twisted
External sheath, color	black
External cable diameter D	6.3 mm ±0.2 mm
Smallest bending radius, fixed installation	63 mm
Outer sheath, material	PUR
Material, inner sheath	PVC
Material conductor insulation	PVC
Conductor material	Bare Cu litz wires
Insulation resistance	≥ 20 MΩ*km
Conductor resistance	26 Ω/km (at 20 °C)
Nominal voltage, cable	300 V
Test voltage, cable	1200 V
Flame resistance	According to DIN VDE 0482
	According to DIN EN 50265-2-1

# Double valve connector cable - SAC-10,0/0,2-116/2XB-1L-Z - 1458279

## Technical data

### Cable

	in acc. with UL FT-2
Ambient temperature (operation)	-40 °C ... 80 °C (cable, fixed installation)
	-5 °C ... 80 °C (cable, flexible installation)

## Classifications

### eCl@ss

eCl@ss 4.0	27060306
eCl@ss 4.1	27060306
eCl@ss 5.0	27061801
eCl@ss 5.1	27061801
eCl@ss 6.0	27061801
eCl@ss 7.0	27061801
eCl@ss 8.0	27279218

### ETIM

ETIM 4.0	EC001855
ETIM 5.0	EC001855

### UNSPSC

UNSPSC 6.01	31251501
UNSPSC 7.0901	31251501
UNSPSC 11	31251501
UNSPSC 12.01	31251501
UNSPSC 13.2	31251501

## Accessories

### Accessories

#### Conductor marking

Insert label - PABA WH/15 - 1013151



Insert label, Strip, white, unlabeled, can be labeled with: Plotter, Mounting type: Thread on, Cable diameter: 0.6-50 mm, Lettering field: 15 x 4 mm

## Double valve connector cable - SAC-10,0/0,2-116/2XB-1L-Z - 1458279

### Accessories

Insert label - PABA YE/15 - 1013698



Insert label, Strip, yellow, unlabeled, can be labeled with: Plotter, Mounting type: Thread on, Cable diameter: 0.6-50 mm, Lettering field: 15 x 4 mm

---

Insert label - PABA RD/15 - 1013944



Insert label, Strip, red, unlabeled, can be labeled with: Plotter, Mounting type: Thread on, Cable diameter: 0.6-50 mm, Lettering field: 15 x 4 mm

---

### Cutting tools

Diagonal cutter - CUTFOX-S VDE - 1212207



Diagonal cutter for copper and aluminum conductors, VDE-tested

---

### Marker carrier cable

Conductor marker carrier - PATG 2/15 - 1013038



Conductor marker carrier, transparent, unlabeled, Mounting type: slide on, Cable diameter: 2-4 mm, Lettering field: 4 x 15 mm

---

Conductor marker carrier - PATG 3/15 - 1013041



Conductor marker carrier, transparent, unlabeled, Mounting type: slide on, Cable diameter: 4-7 mm, Lettering field: 4 x 15 mm

---

## Double valve connector cable - SAC-10,0/0,2-116/2XB-1L-Z - 1458279

### Accessories

Conductor marker carrier - PATG 4/15 - 1013054



Conductor marker carrier, transparent, unlabeled, Mounting type: slide on, Cable diameter: 6-10 mm, Lettering field: 4 x 15 mm

---

### Marker pen

Marker pen - B-STIFT - 1051993



Marker pen, for manual labeling of unprinted Zack strips, smear-proof and waterproof, line thickness 0.5 mm

---

### Screwdriver tools

Screw insert - SF-BIT-PH 1-70 - 1212582



Screw bit, PH crosshead, E6.3-1/4" drive, size: PH 1 x 70 mm, hardened, suitable for holder according to DIN 3126-F6.3/ISO 1173

---

### Stripping tool

Stripping tool - WIREFOX SAC-1 - 1212757



Stripping pliers, for halogen-free sensor/actuator cables (SAC cables), with PUR and PVC insulation, from Ø of 3.2 to 4.4 mm, any stripping length

Stripping tool - WIREFOX SAC - 1212623



Stripping pliers, for halogen-free sensor/actuator cables (SAC cables), with PUR and PVC insulation, from Ø of 4.4 to 7 mm, any stripping length

# Double valve connector cable - SAC-10,0/0,2-116/2XB-1L-Z - 1458279

## Accessories

Stripping tool - WIREFOX 10 - 1212150



Stripping tool, for cables and conductors from 0.02 - 10 mm<sup>2</sup>, self-adjusting, stripping length of up to 18 mm, cutting capacity of up to 10 mm<sup>2</sup> stranded/1.5 mm<sup>2</sup> solid, replaceable stripping blade

---

## Torque tool

Torque screwdriver - TSD-M 1,2NM - 1212224



Torque screw driver, accuracy as per EN ISO 6789 standard, adjustable from 0.3 - 1.2 Nm

---

## Drawings

Schematic diagram

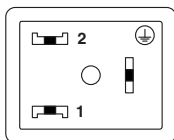

Valve connector pin assignment, type B

Cable cross section

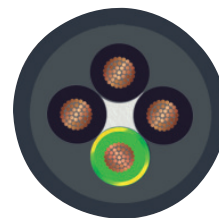

PUR/PVC black [116]

# Double valve connector cable - SAC-10,0/0,2-116/2XB-1L-Z - 1458279

Dimensioned drawing

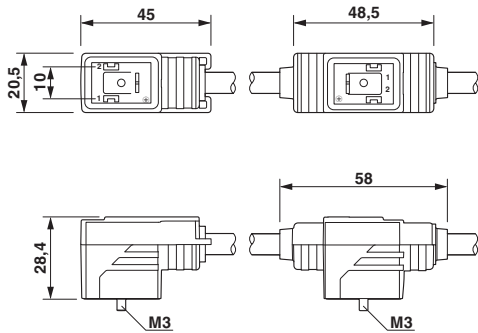

Dimensioned drawing

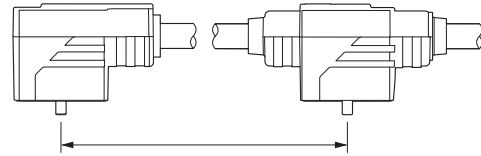

Valve connector spacing

Double valve plug, 2 x type B

Circuit diagram

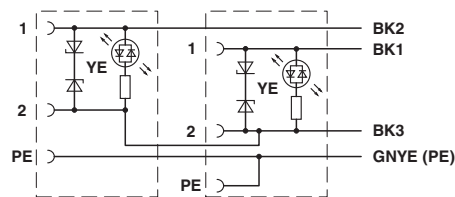

Contact assignment of the double-valve connector