

IEC Appliance Inlet C14 or C18 with Fuseholder 1- or 2-pole



Snap-In Version



Description

- Panel Mount:
Snap-in version, from front side Appliance Inlet, Protection class I, Fuseholder for fuse-links 5 x 20 mm
- Solder terminals or quick connect terminals

Approvals

- UL File Number: E93617
- CSA File Number: 27324

Characteristics

- The fuse drawer "Fingerrip" can be removed by hand

Weblinks

[pdf-datasheet](#), [html-datasheet](#), [General Product Information](#), [Approvals](#), [CE declaration of conformity](#), [RoHS](#), [CHINA-RoHS](#), [REACH](#), [Mating Connectors](#), [e-Shop](#), [SCHURTER-Stock-Check](#), [Distributor-Stock-Check](#), [CAD-Drawings](#), [Accessories](#), [Detailed request for product](#)

Technical Data

Ratings IEC	10A / 250VAC; 50Hz
Ratings UL/CSA	10A / 250VAC; 60Hz
Dielectric Strength	> 3kVAC between L-N > 1.5kVAC between L/N-PE (1 min/50Hz)
Allowable Operation Temp.	-25 °C to 70 °C
Degree of Protection	from front side IP 20 acc. to IEC 60529
Protection Class	Suitable for appliances with protection class I or II acc. to IEC 61140
Terminal	Solder terminals or quick connect terminals
Panel Thickness s	Snap-in 1.0 - 2.5 mm
Material: Housing	PA6, black / grey / white, UL 94V-0

Appliance Inlet	C14 / C18 acc. to IEC 60320-1 UL 498, CSA C22.2 no. 42 (for cold conditions) pin-temperature 70 °C, 10A, Protection Class I or II
Fuseholder	1 or 2 pole, acc. to IEC 60127-6, for fuse-links 5 x 20 mm
Power Acceptance @ Ta > 23°C	Admissible power acceptance at higher ambient temperature see derating curves

Dimensions

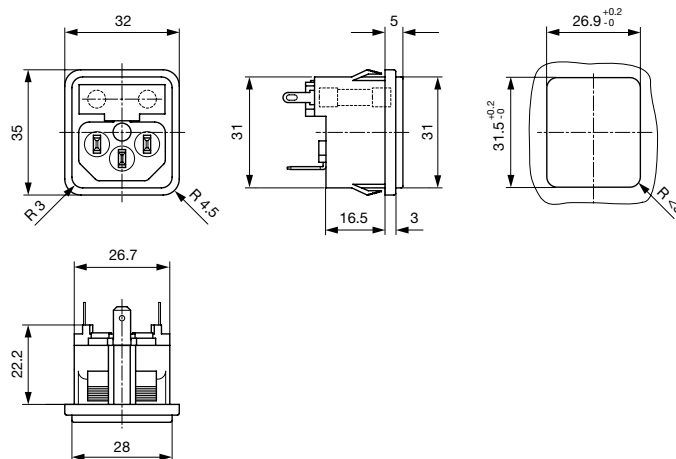

Length of the terminal please find at the order code configuration table

Derating Curves

Fuses

5 x 20 mm (1-pole)

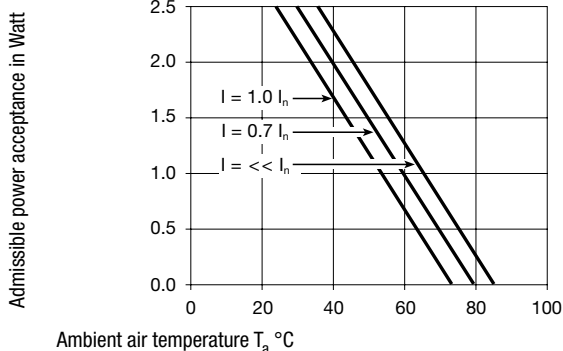

2-pole

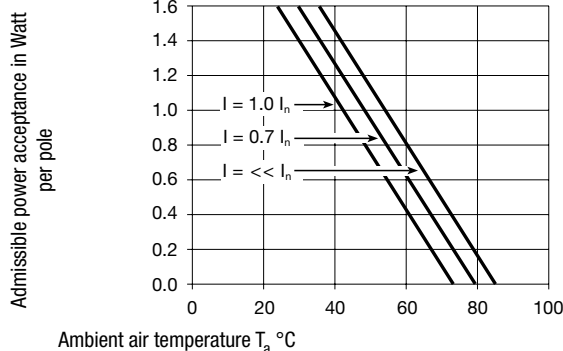

Config. Code

1064 - H - A B C N - D - E G O

The characters are placeholders for the correspondingly keys of selections from the key tables.





1064 - **H** - A B C N - D - E G O = Type

Type	Configuration key
protection class II	B
protection class I	X

Terminal Ground	Configuration key
without terminal	0
short solder terminal (L = 4.8 mm)	2
long solder terminal (L = 8.5 mm)	3
Blade terminal (4.8 x 0.8 mm)	8
Blade terminal (6.3 x 0.8 mm)	9

Symbols similar as in table A

1064 - H - **A** B C N - D - E G O = Terminals

Terminal L	Configuration key
short solder terminal (L = 4.8 mm) 	2
long solder terminal (L = 8.5 mm) 	3
Blade terminal (4.8 x 0.8 mm) 	8
Blade terminal (6.3 x 0.8 mm) 	9
connection to fuse holder	B

1064 - H - A B C **N** - D - E G O = Terminal Fuseholder

Terminal Fuseholder	Configuration key
solder terminal	1

1064 - H - A B C N - **D** - E G O = Color

Color	Configuration key
Black	A
Grey	B
White	D

1064 - H - A **B** C N - D - E G O = Terminals

Terminal N	Configuration key
short solder terminal (L = 4.8 mm)	2
long solder terminal (L = 8.5 mm)	3
Blade terminal (4.8 x 0.8 mm)	8
Blade terminal (6.3 x 0.8 mm)	9
connection to fuse holder	B

1064 - H - A B C N - D - **E** G O = Style

Style	Configuration key
snap-in standard type	3

1064 - H - A B C N - D - E **G** O = Mass S

Mass "s"	Configuration key
00	

The dimension "S" is displayed in (1/10 mm). This information is also valid for the order code

1064 - H - A B **C** N - D - E G O = Terminals

1064 - H - A B C N - D - E G O = Features

Features	Configuration key
dead cover	1

Features

Features	Configuration key
holder for 1 or 2 fuses (text legible, when inlet on top)	4
holder for 1 or 2 fuses (text legible, when inlet on bottom)	5

All Variants

Config. Code	Description	Order Number
1064-X-B221-A-3004	1064, IEC Power Entry Module C14, 70°C, version: protection class I, L: connection to fuse holder, N: short solder terminal (L = 4.8 mm), ground: short solder terminal (L = 4.8 mm), fuseholder: solder terminal, color: Black, design: snap-in standard type, dimension S: 00, features: holder for 1 or 2 fuses (text legible, when inlet on top), not used	4304.6025
1064-X-B881-A-3004	1064, IEC Power Entry Module C14, 70°C, version: protection class I, L: connection to fuse holder, N: Blade terminal (4.8 x 0.8 mm), ground: Blade terminal (4.8 x 0.8 mm), fuseholder: solder terminal, color: Black, design: snap-in standard type, dimension S: 00, features: holder for 1 or 2 fuses (text legible, when inlet on top), not used	4304.6026
1064-X-B991-A-3004	1064, IEC Power Entry Module C14, 70°C, version: protection class I, L: connection to fuse holder, N: Blade terminal (6.3 x 0.8 mm), ground: Blade terminal (6.3 x 0.8 mm), fuseholder: solder terminal, color: Black, design: snap-in standard type, dimension S: 00, features: holder for 1 or 2 fuses (text legible, when inlet on top), not used	4304.6027
1064-X-BB21-A-3004	1064, IEC Power Entry Module C14, 70°C, version: protection class I, L: connection to fuse holder, N: connection to fuse holder, ground: short solder terminal (L = 4.8 mm), fuseholder: solder terminal, color: Black, design: snap-in standard type, dimension S: 00, features: holder for 1 or 2 fuses (text legible, when inlet on top), not used	4304.6028
1064-X-BB21-A-3005	1064, IEC Power Entry Module C14, 70°C, version: protection class I, L: connection to fuse holder, N: connection to fuse holder, ground: short solder terminal (L = 4.8 mm), fuseholder: solder terminal, color: Black, design: snap-in standard type, dimension S: 00, features: holder for 1 or 2 fuses (text legible, when inlet on bottom), not used	4304.6029
1064-X-BB81-A-3004	1064, IEC Power Entry Module C14, 70°C, version: protection class I, L: connection to fuse holder, N: connection to fuse holder, ground: Blade terminal (4.8 x 0.8 mm), fuseholder: solder terminal, color: Black, design: snap-in standard type, dimension S: 00, features: holder for 1 or 2 fuses (text legible, when inlet on top), not used	4304.6030
1064-X-BB91-A-3004	1064, IEC Power Entry Module C14, 70°C, version: protection class I, L: connection to fuse holder, N: connection to fuse holder, ground: Blade terminal (6.3 x 0.8 mm), fuseholder: solder terminal, color: Black, design: snap-in standard type, dimension S: 00, features: holder for 1 or 2 fuses (text legible, when inlet on top), not used	4304.6031
1064-X-BB21-D-3004	1064, IEC Power Entry Module C14, 70°C, version: protection class I, L: connection to fuse holder, N: connection to fuse holder, ground: short solder terminal (L = 4.8 mm), fuseholder: solder terminal, color: White, design: snap-in standard type, dimension S: 00, features: holder for 1 or 2 fuses (text legible, when inlet on top), not used	4304.6129

The list of variants should be available from stock. Other versions on request www.schurter.com/contact

Most Popular:

Availability for all products can be searched real-time: <http://www.schurter.com/en/Stock-Check/Stock-Check-SCHURTER>

Packaging unit 50 Pcs

Accessories

Description

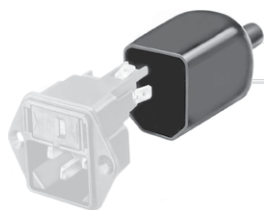

Assorted Covers
Rear Cover

Mating Outlets/Connectors

Category / Description



Appliance Outlet Overview complete

IEC Appliance Outlet F, Screw-on Mounting, Front Side, Solder Terminal	4787
IEC Appliance Outlet F, Snap-in Mounting, Front Side, Solder or Quick-connect Terminal	4788
IEC Appliance Outlet F or H, Screw-on Mounting, Front Side, Solder, PCB or Quick-connect Terminal	5091

[Appliance Outlet further types to 1064](#)

Connector Overview complete



4782 Mounting: Power Cord, 3 x 1 mm ² / 3 x 18 AWG, Cable, Connector: IEC C13	4782
4022 Mounting: Power Supply Cord, 3 x 1.5 mm ² , Screw clamps, Connector: IEC C13	4022
4785 Mounting: Power Cord, 3 x 1 mm ² / 3 x 18 AWG, Cable, Connector: IEC C13	4785
4300-06 Mounting: Power Cord, 3 x 1 mm ² / 3 x 18 AWG, Cable, Connector: IEC C13	4300-06
4012 Mounting: Power Supply Cord, 3 x 1.5 mm ² , Screw clamps, Connector: IEC C13	4012

[Connector further types to 1064](#)

...