

**Ordering number C12476_MIRELLA-50-S**

Family	Mirella	FWHM	9 degrees
Type	Reflector	Efficiency	91 %
LED	Ostar Lighting+	cd/lm	15.600
Color	Metal	Gerber File	Available
Diameter	49.9 mm		
Height	24 mm		
Style	Round		
Optic Material	PC		
Holder Material	-		
Fastening	Glue		
Status	Ready		

**Ordering number CN12483_MIRELLA-50-S-DL**

Family	Mirella	FWHM	13 degrees
Type	Pack	Efficiency	84 %
LED	Ostar Lighting+	cd/lm	7.800
Color	Metal	Gerber File	Available
Diameter	49.9 mm		
Height	23.9 mm		
Style	Round		
Optic Material	PC		
Holder Material	-		
Fastening	Glue		
Status	Ready		

**Ordering number C12477_MIRELLA-50-M**

Family	Mirella	FWHM	21 degrees
Type	Reflector	Efficiency	89 %
LED	Ostar Lighting+	cd/lm	3.800
Color	Metal	Gerber File	Available
Diameter	49.9 mm		
Height	23.9 mm		
Style	Round		
Optic Material	PC		
Holder Material	-		
Fastening	Glue		
Status	Ready		

**Ordering number CN12484_MIRELLA-50-M-DL**

Family	Mirella	FWHM	27 degrees
Type	Pack	Efficiency	83 %
LED	Ostar Lighting+	cd/lm	2.400
Color	Metal	Gerber File	Available
Diameter	49.9 mm		
Height	23.9 mm		
Style	Round		
Optic Material	PC		
Holder Material	-		
Fastening	Glue		
Status	Ready		

Ordering number C12478_MIRELLA-50-W

Family	Mirella	FWHM	37 degrees
Type	Reflector	Efficiency	88 %
LED	Ostar Lighting+	cd/lm	1.700
Color	Metal	Gerber File	Available
Diameter	49.9 mm		
Height	23.9 mm		
Style	Round		
Optic Material	PC		
Holder Material	-		
Fastening	Glue		
Status	Ready		

Ordering number CN12485_MIRELLA-50-W-DL

Family	Mirella	FWHM	43 degrees
Type	Pack	Efficiency	82 %
LED	Ostar Lighting+	cd/lm	1.300
Color	Metal	Gerber File	Available
Diameter	49.9 mm		
Height	23.9 mm		
Style	Round		
Optic Material	PC		
Holder Material	-		
Fastening	Glue		
Status	Ready		

NOTE: The typical divergence will be changed by different color, chip size and chip position tolerance. The typical total divergence is the full angle measured where the luminous intensity is half of the peak value.



PRODUCT DATASHEET

Mirella series

last update 3/10/2012



GENERAL INFORMATION

- Product series especially designed & optimized for Ostar Lighting+ series of LEDs.
- Special care taken to make light distribution as uniform as possible.
- Lens material optical grade PC with high UV and temperature resistance (120 degrees of Celcius / 248 degrees of Fahrenheit). Allows use of high current and temperature conditions.

Please find more information about used materials from below:

http://ledil.fi/sites/default/files/Documents/Technical/Material/PC%20Makrolon%202400_2407_2456_2458-UL.pdf

- Reflector is made of aluminium coated PC (120 degrees of Celcius / 248 degrees of Fahrenheit) with protective lacquer (110 degrees of Celcius / 230 degrees of Fahrenheit).

- Fastening to PCB with appropriate adhesive. By clicking link below you can find Ledil recommended glue options.

http://www.ledil.com/datasheets/DataSheet_GLUES.pdf

NOTE 1: We advise customer to ensure the suitability and sufficiency of the bond in the end product. For example, mechanical stress, vibration and holes on the surface of the circuit board weaken the strength of the glue.

NOTE 2: All surfaces where glue is applied must be clean, dry and free from grease and dirt. If cleaning of PCB surfaces is needed, please follow strictly the cleaning instructions of your LED manufacturer -this is important as cleaning shall under no circumstances damage LEDs or other electronics components on the PCB.

Further note that optical components shall not be cleaned with any chemicals - only micro fiber cloth may be used to remove fingerprints or other traces from handling.

Relative intensity of CN12484_MIRELLA-50-M-DL_(OstarLighting+)

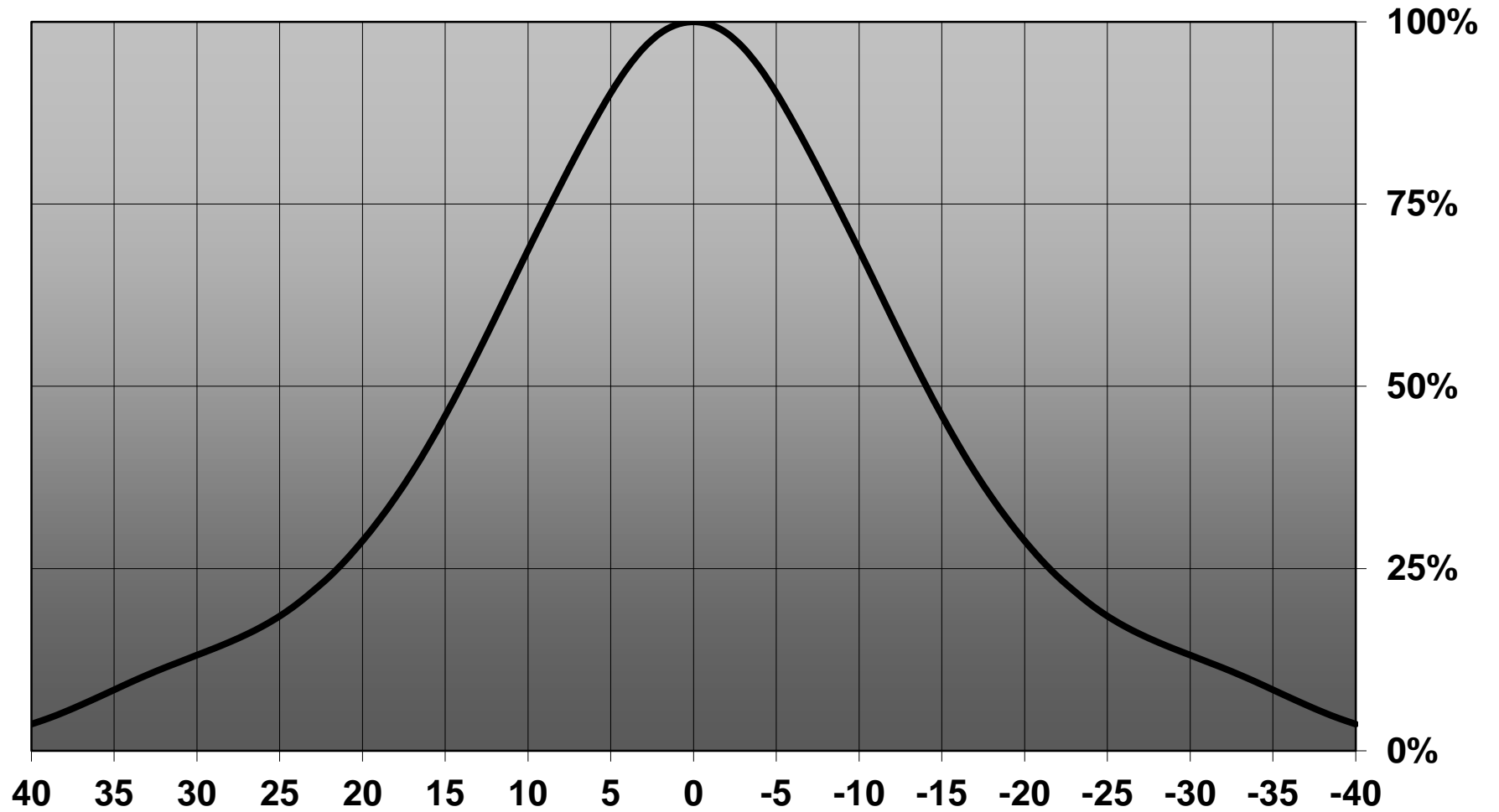

Relative intensity of C12478_MIRELLA-50-W_(OstarLighting+)

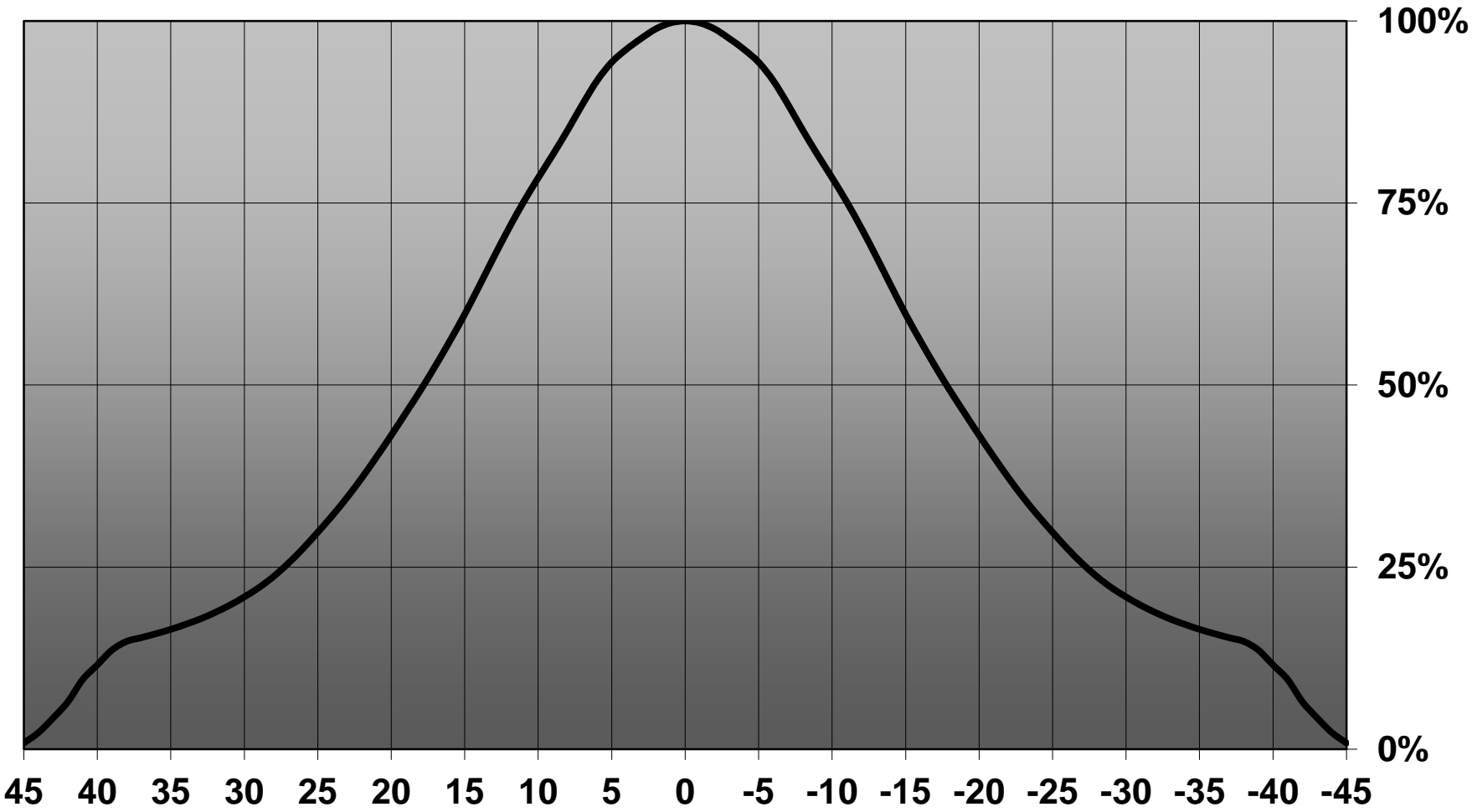

Relative intensity of CN12485_MIRELLA-50-W-DL_(OstarLighting+)

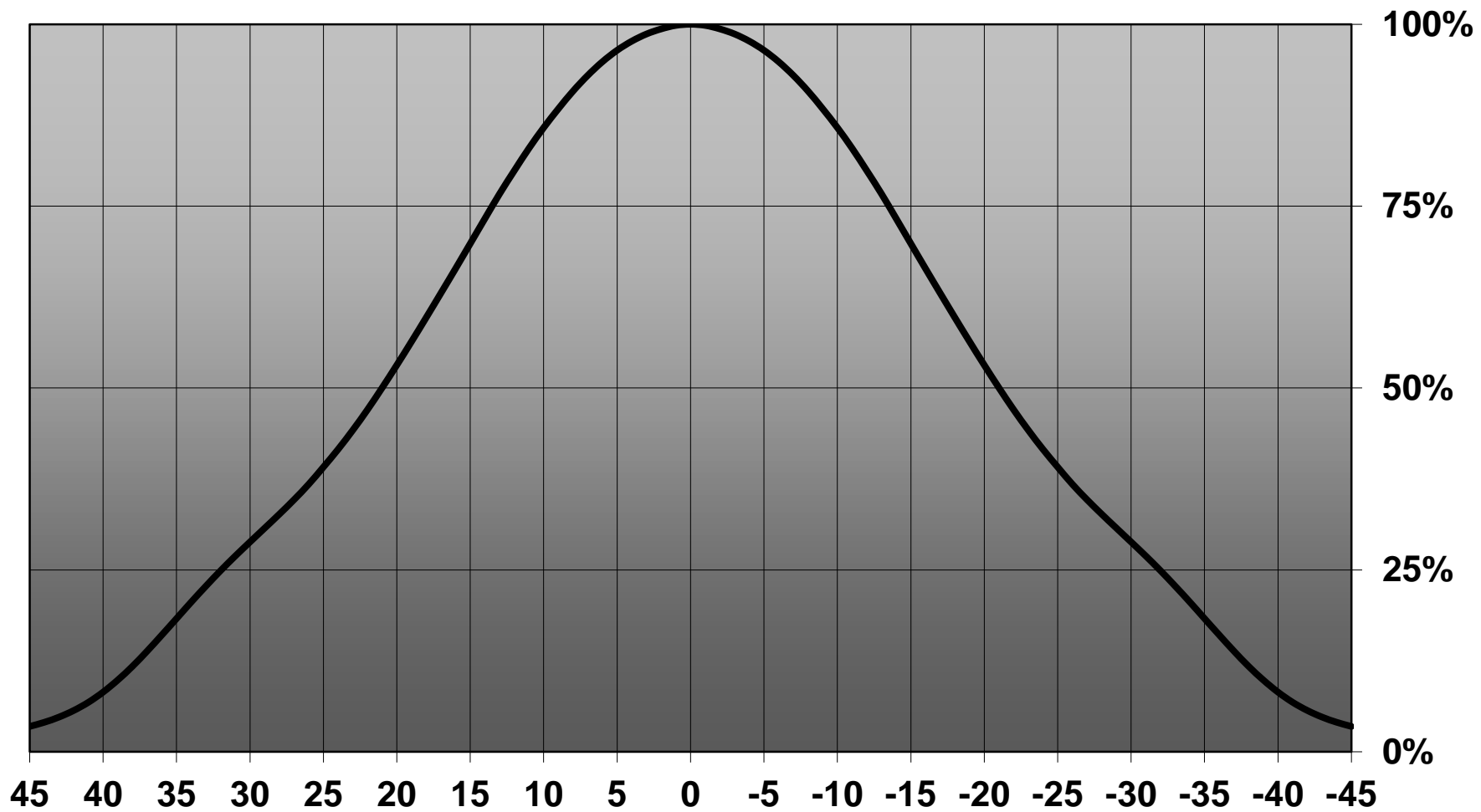

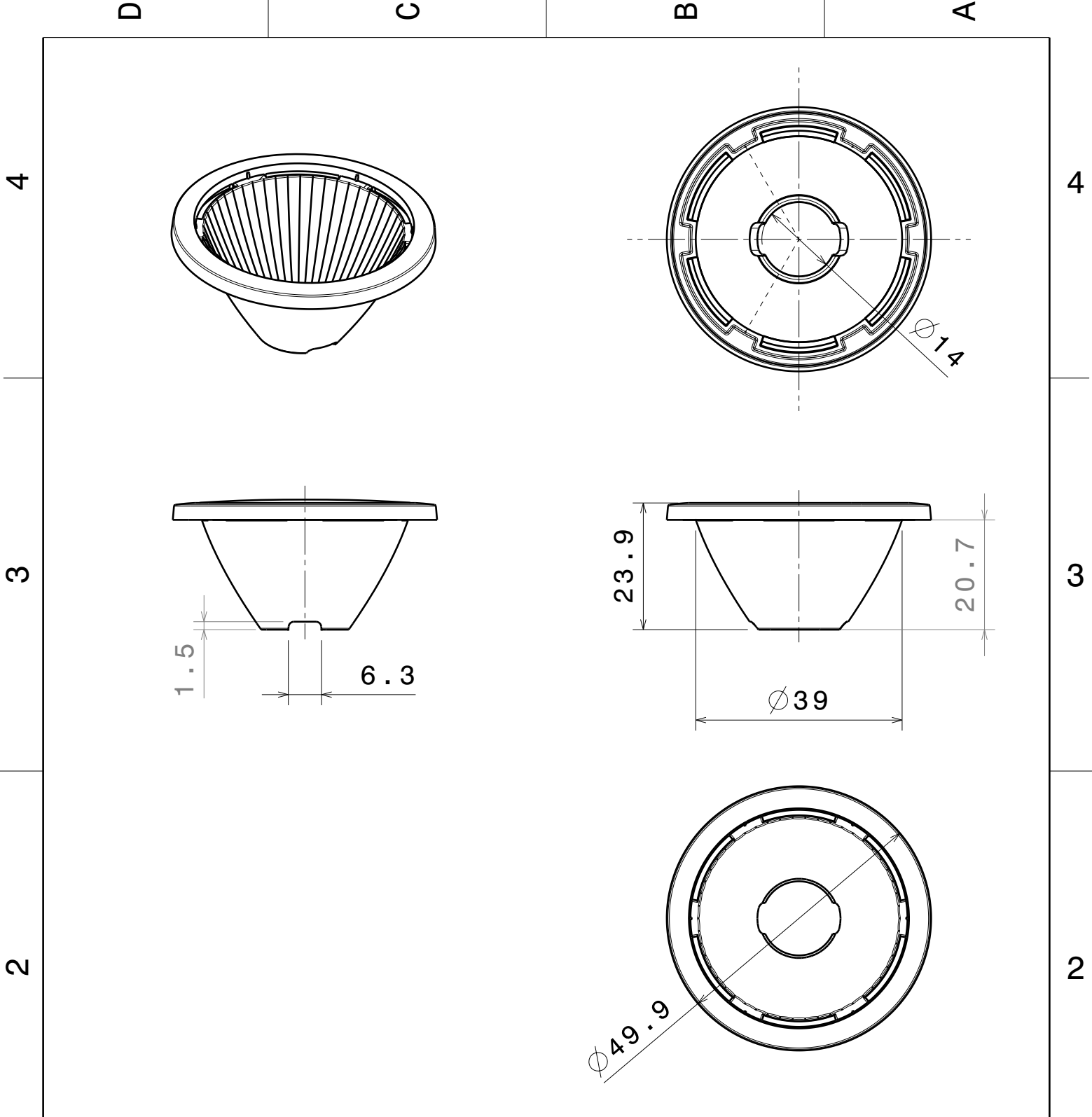

Material: PC, metal plated

This drawing is our property. It can't be reproduced or communicated without our written agreement.



Ledil Oy
Salorankatu 10
FIN-24240 SALO
Finland

DRAWING TITLE

Datasheet Mirella reflector

DRAWN BY pl		DATE 25.11.2011		SIZE A4		DRAWING NUMBER		REV 1	
CHECKED BY		DATE		SCALE 1:1		WEIGHT (g)		SHEET 1/1	
DESIGNED BY pl		DATE 25.11.2011							

D

A

Luminaire: LEDIL OY C12476_MIRELLA-50-S_(OstarLighting+) Eff.91.0%
Lamps: 1 x Ostar Lighting+ (268.9lm@250mA)

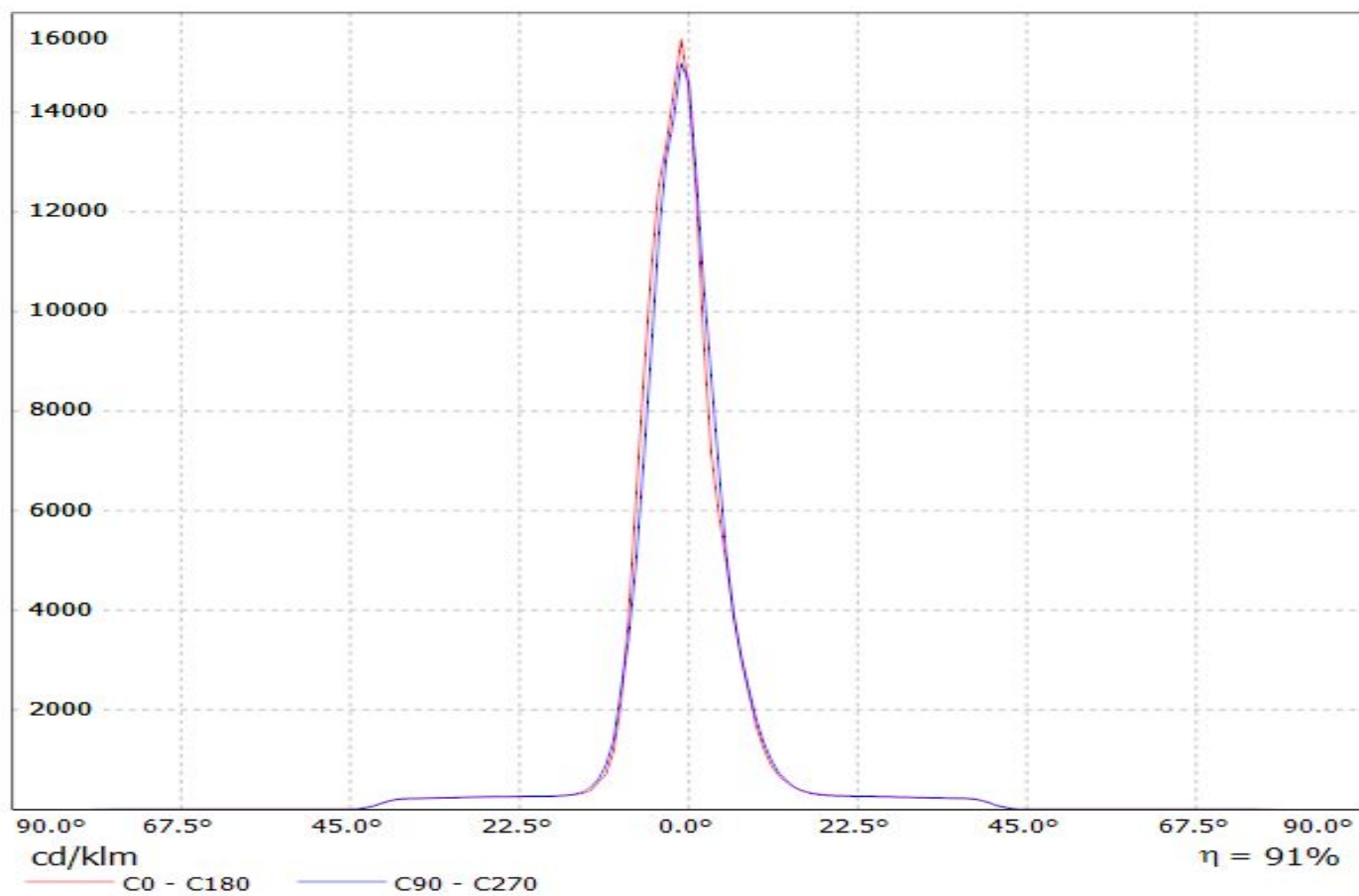

Luminaire: LEDIL OY CN12483_MIRELLA-50-S-DL_(OstarLighting+) Eff.84.2%
Lamps: 1 x Ostar Lighting+ (268.9lm@250mA)

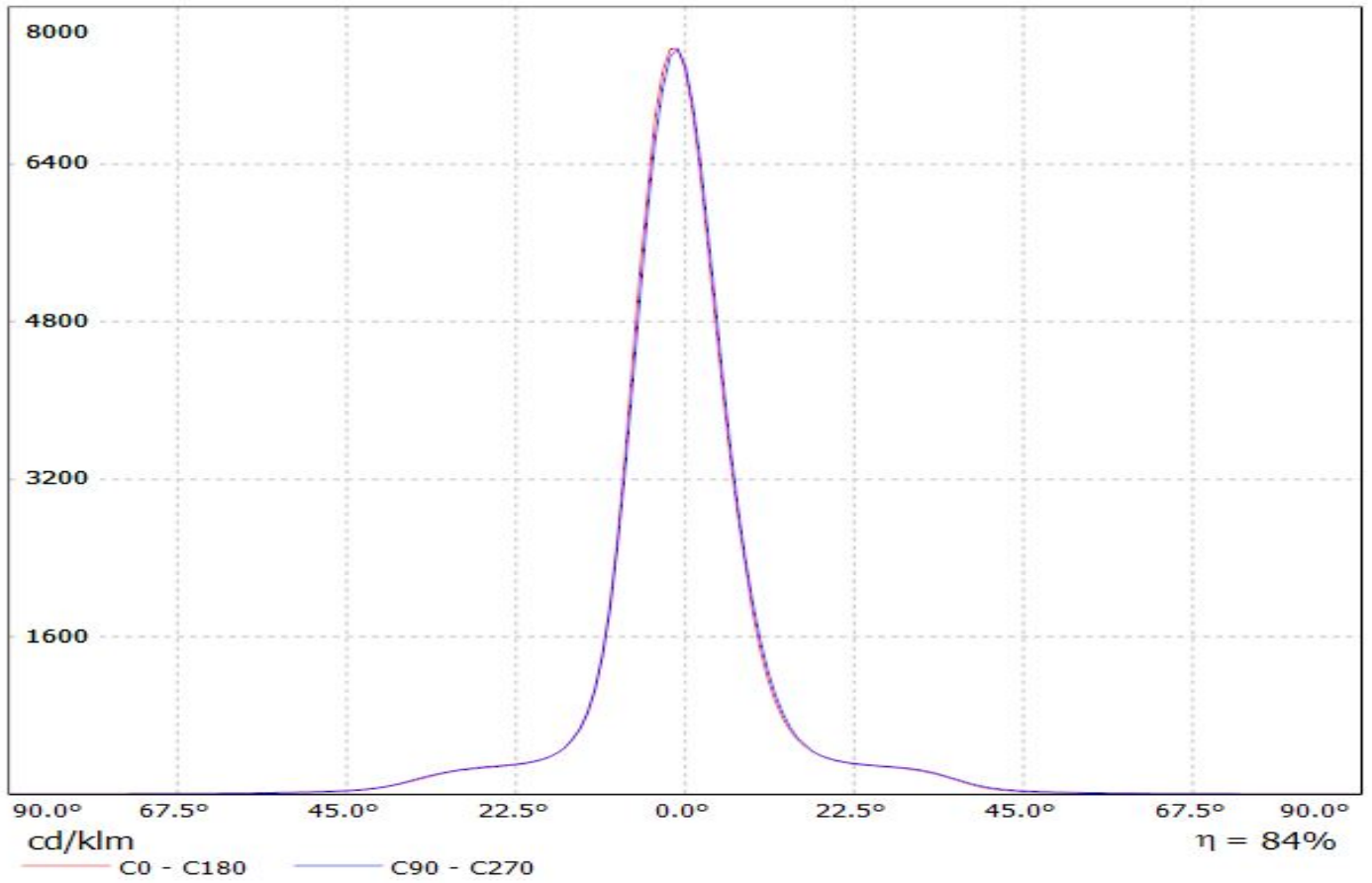

Luminaire: LEDIL OY C12477_MIRELLA-50-M_(OstarLighting+) Eff.89.9%
Lamps: 1 x Ostar Lighting+ (268.9lm@250mA)

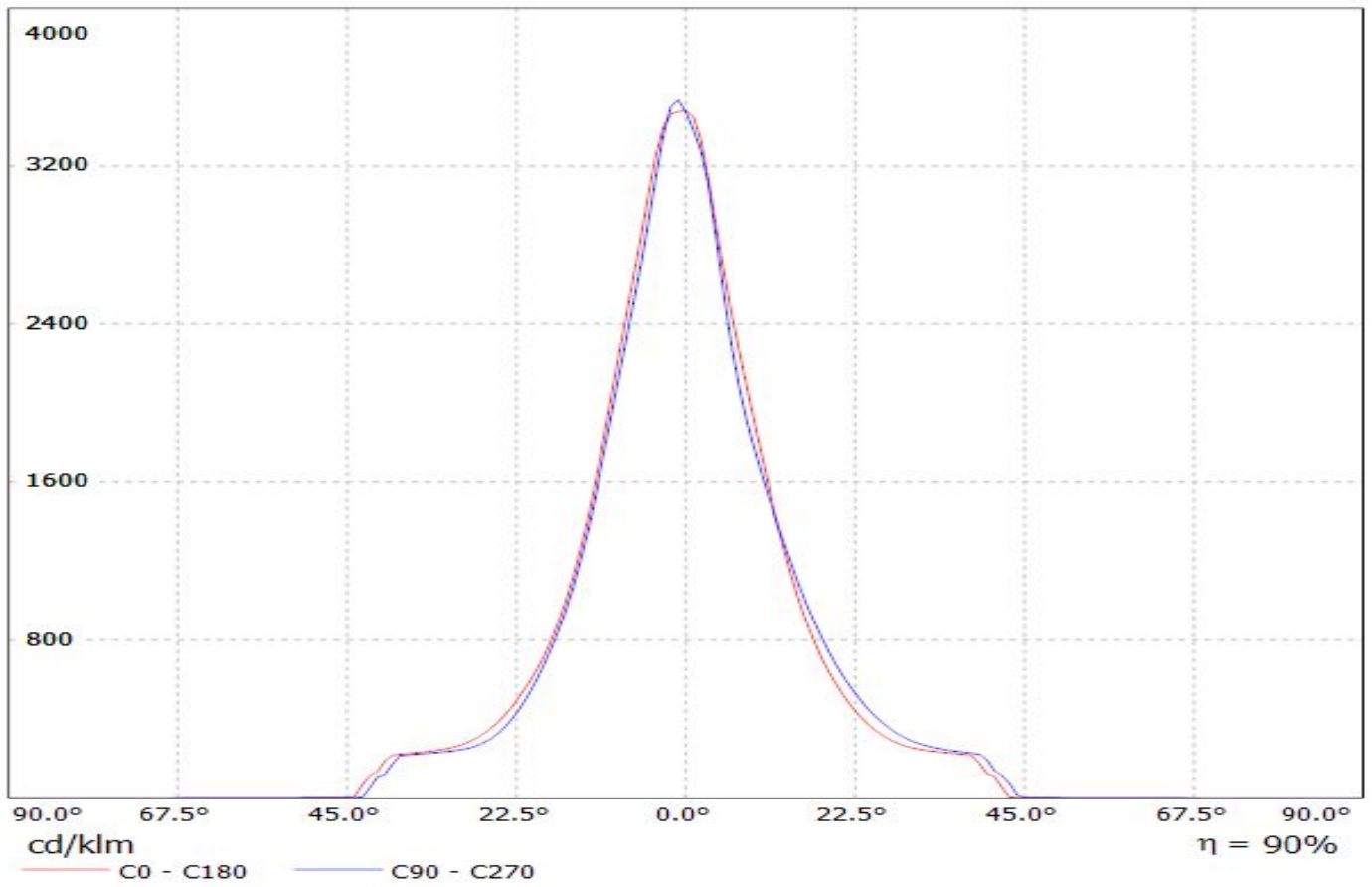

Luminaire: LEDIL OY CN12484_MIRELLA-50-M-DL_(OstarLighting+) Eff.83.5%
Lamps: 1 x Ostar Lighting+ (268.9lm@250mA)

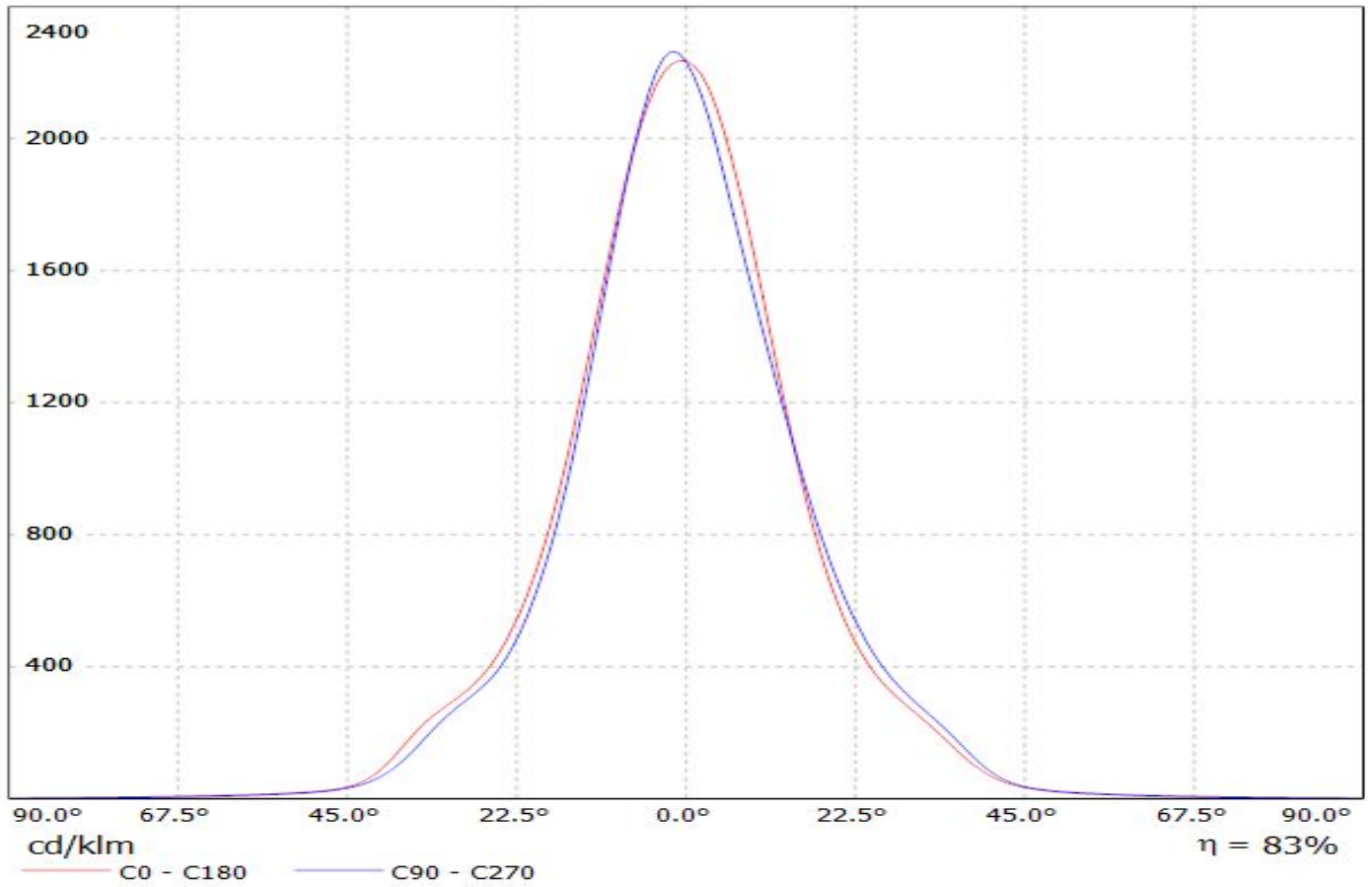

Luminaire: LEDIL OY C12478_MIRELLA-50-W_(OstarLighting+) Eff.88.3%
Lamps: 1 x Ostar Lighting+ (268.9lm@250mA)

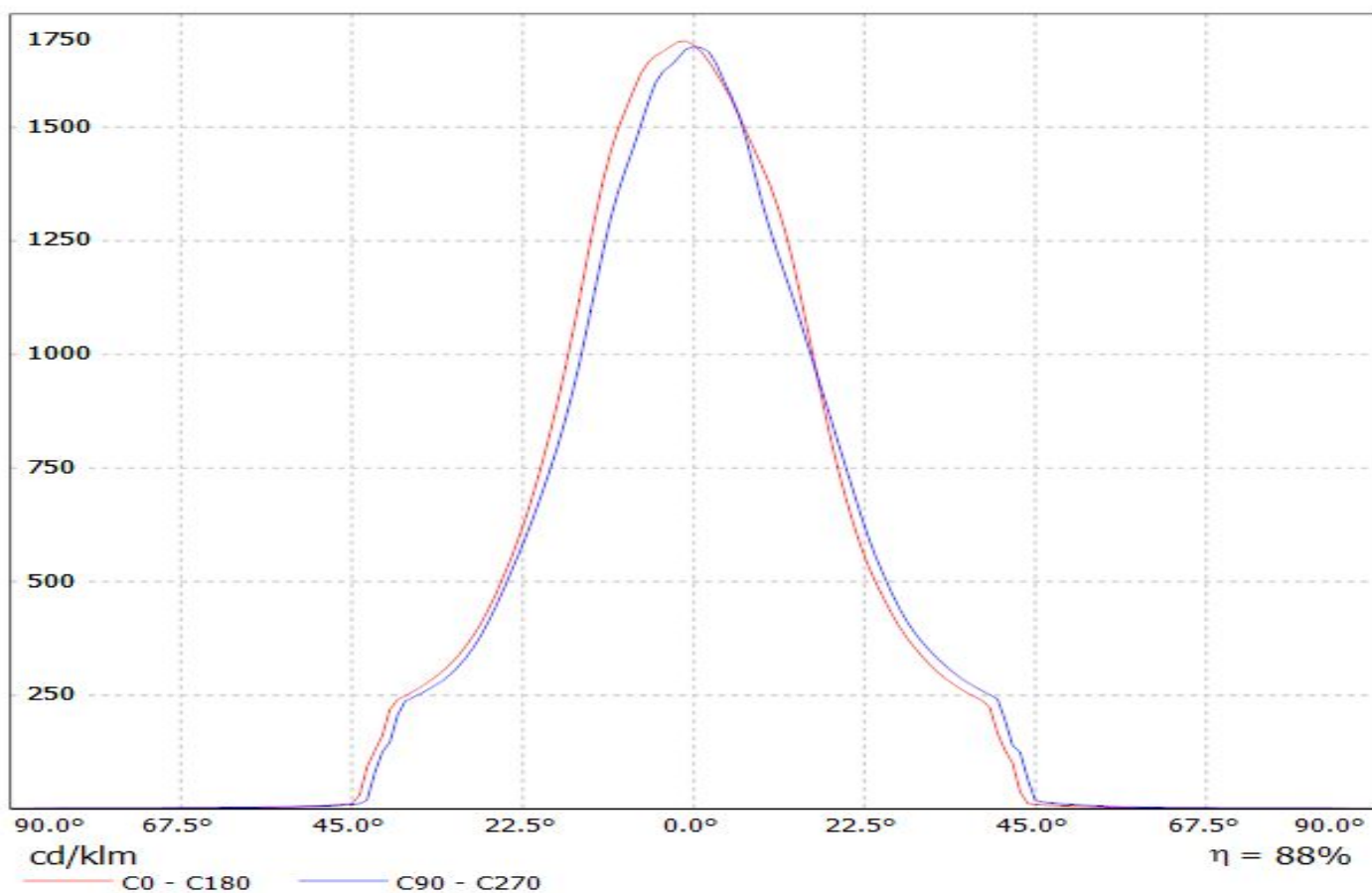

Luminaire: LEDIL OY CN12485_MIRELLA-50-W-DL_(OstarLighting+) Eff.82.1
Lamps: 1 x Ostar Lighting+ (268.9lm@250mA)

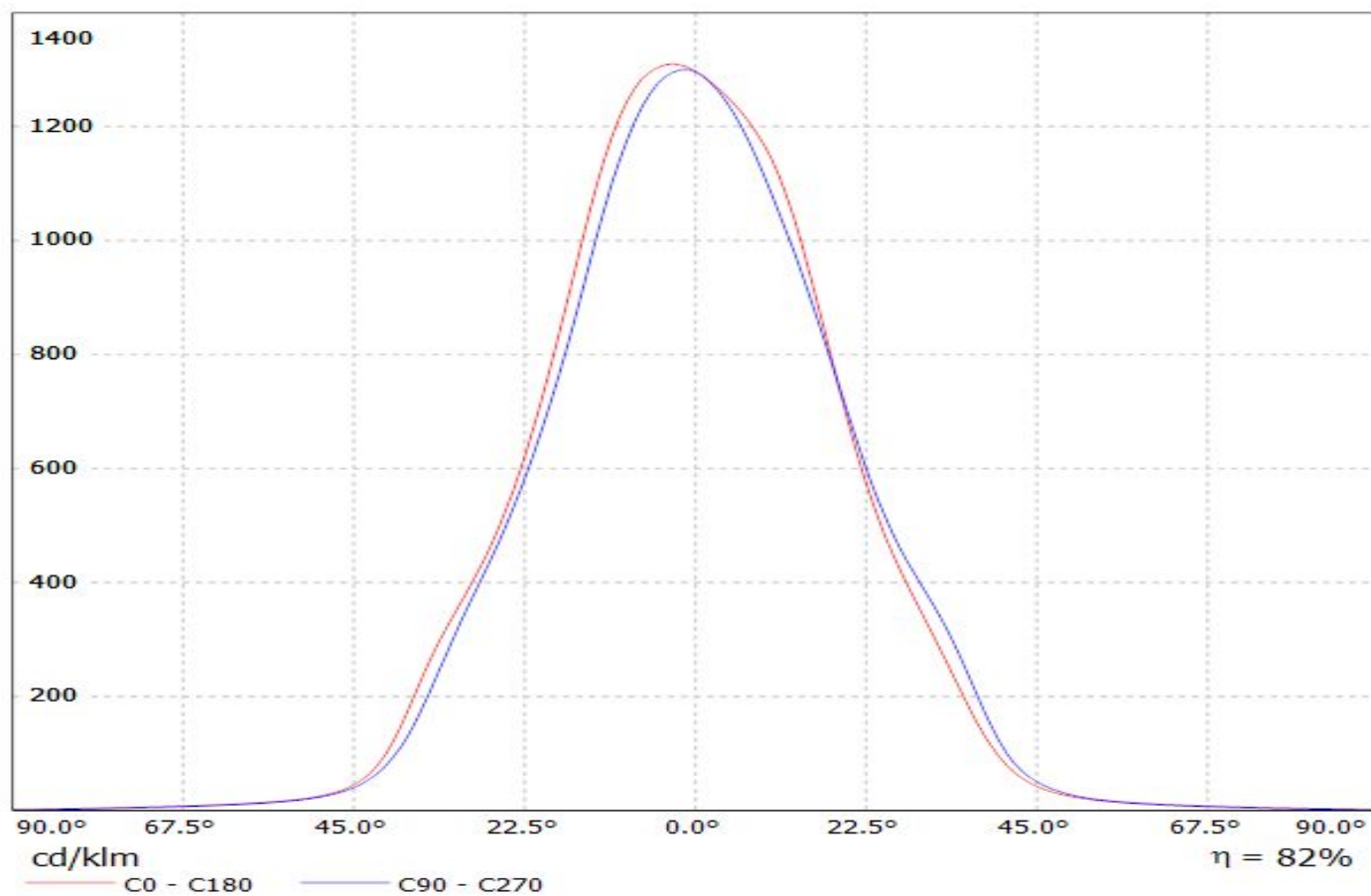

Luminaire: LEDIL OY C12476_MIRELLA-50-S_(OstarLighting+) Eff.91.0%
Lamps: 1 x Ostar Lighting+ (268.9lm@250mA)

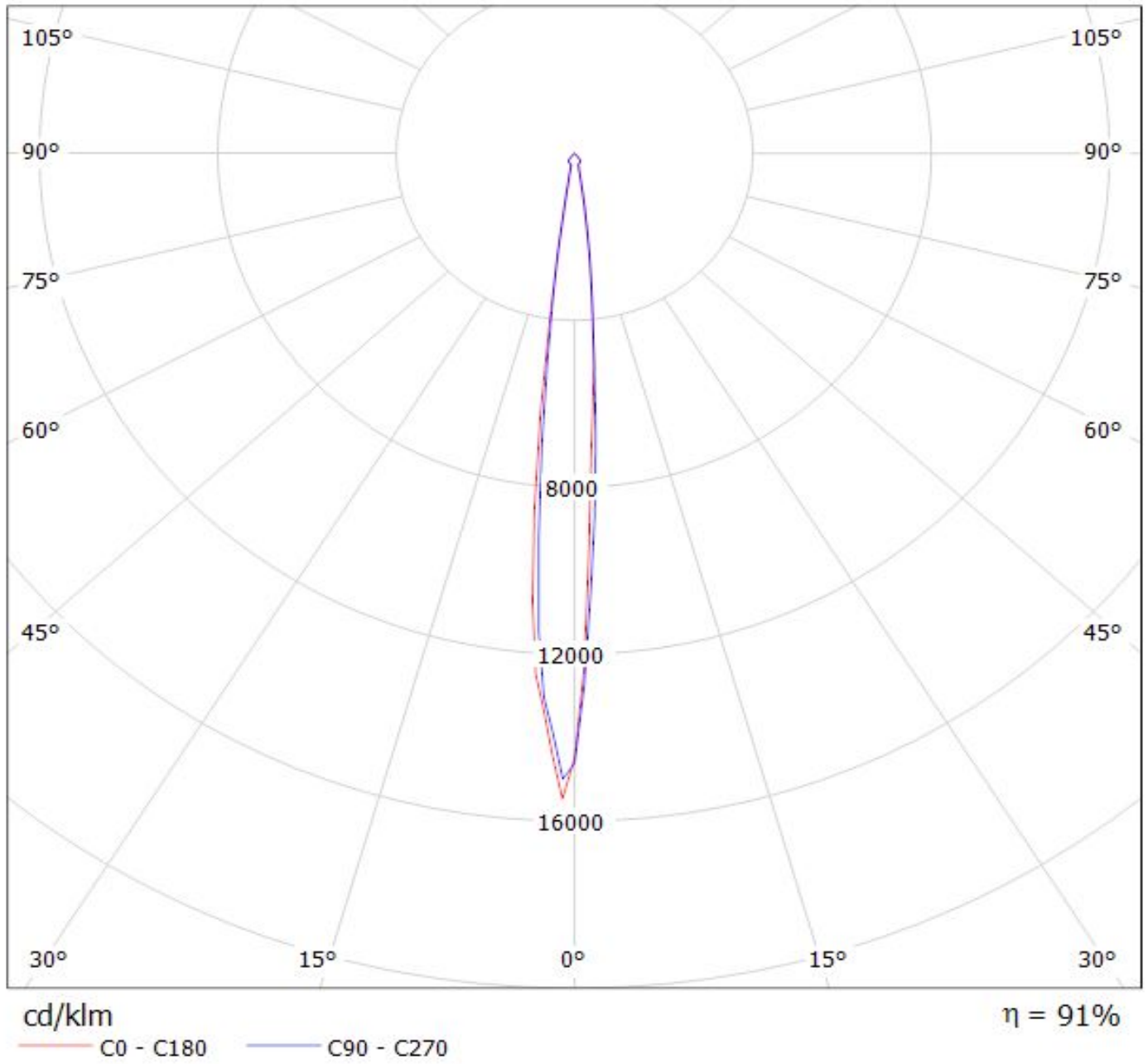

Luminaire: LEDIL OY CN12483_MIRELLA-50-S-DL_(OstarLighting+) Eff.84.2%
Lamps: 1 x Ostar Lighting+ (268.9lm@250mA)

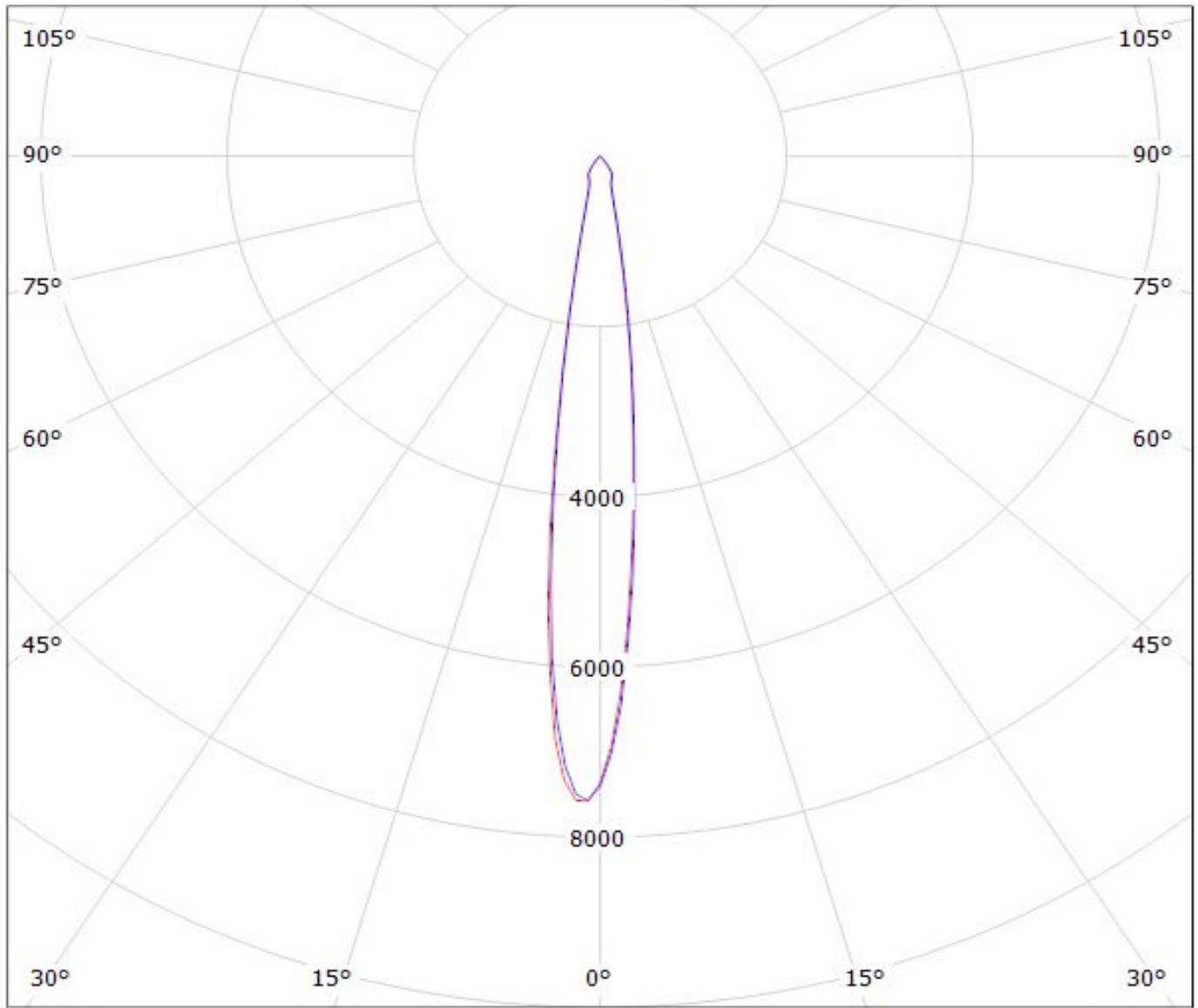

cd/klm

— C0 - C180 — C90 - C270

$\eta = 84\%$

Luminaire: LEDIL OY C12477_MIRELLA-50-M_(OstarLighting+) Eff.89.9%
Lamps: 1 x Ostar Lighting+ (268.9lm@250mA)

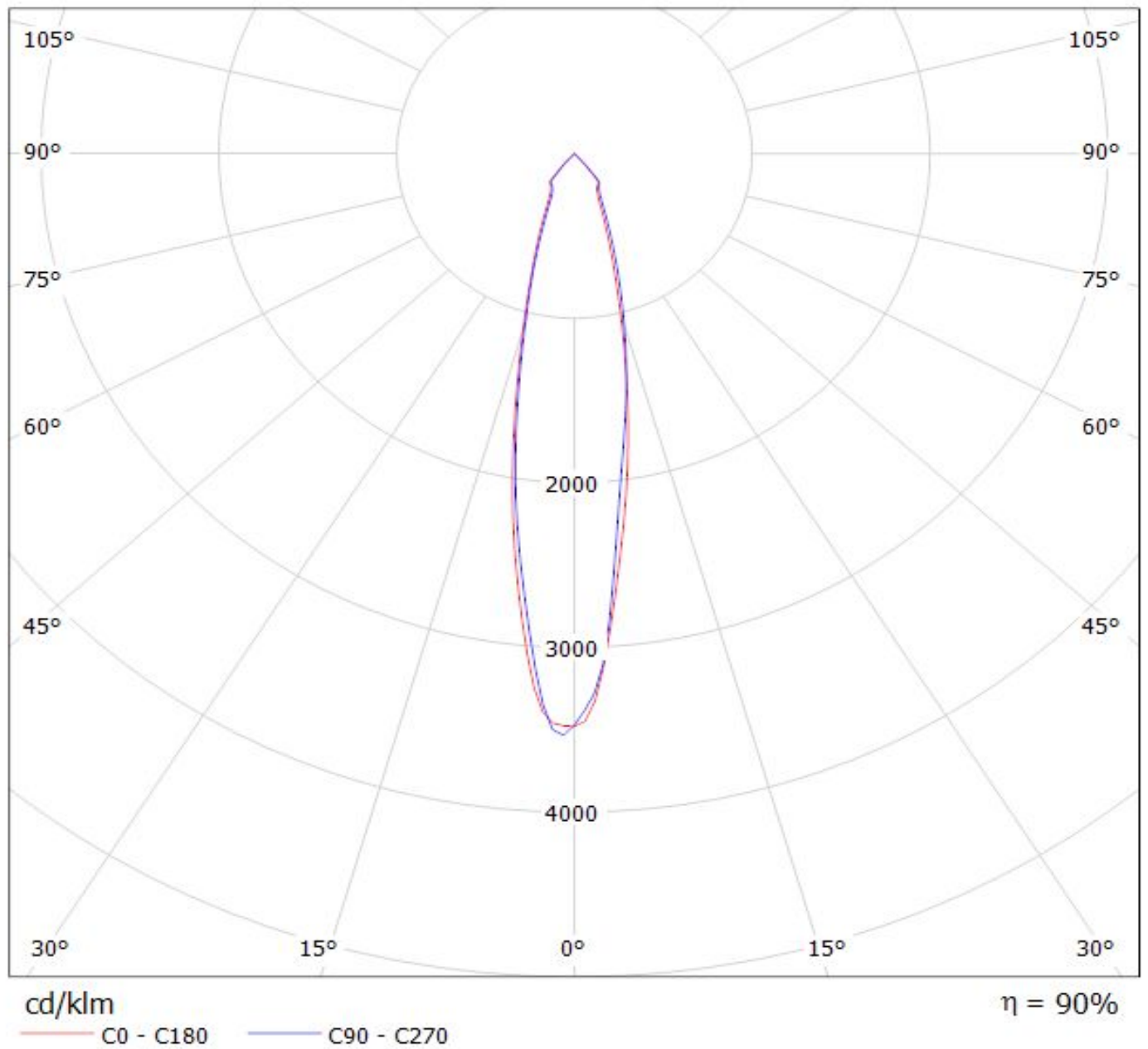

Luminaire: LEDIL OY CN12484_MIRELLA-50-M-DL_(OstarLighting+) Eff.83.5%
Lamps: 1 x Ostar Lighting+ (268.9lm@250mA)

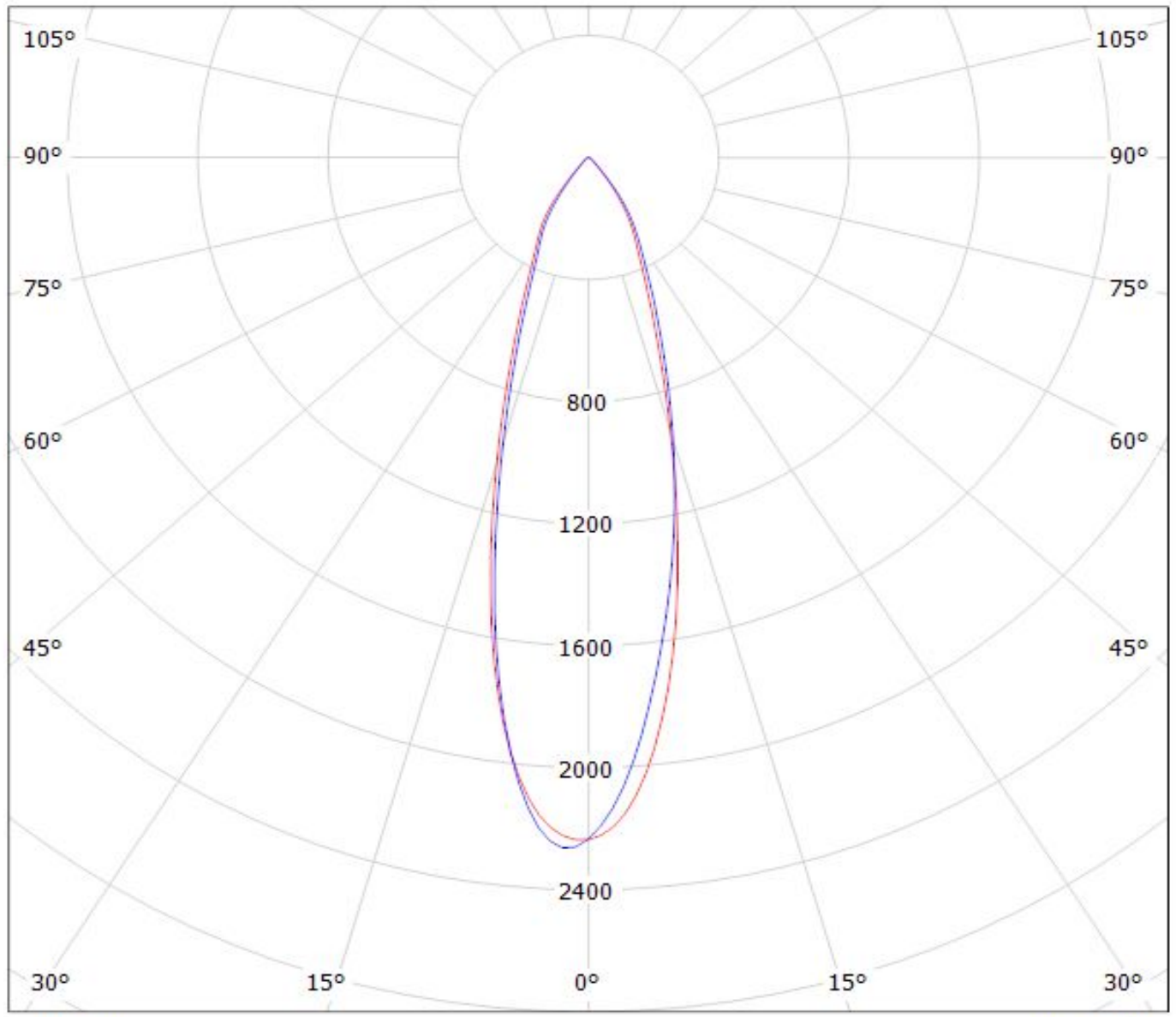

cd/klm

— C0 - C180

— C90 - C270

$\eta = 83\%$

Luminaire: LEDIL OY C12478_MIRELLA-50-W_(OstarLighting+) Eff.88.3%
Lamps: 1 x Ostar Lighting+ (268.9lm@250mA)

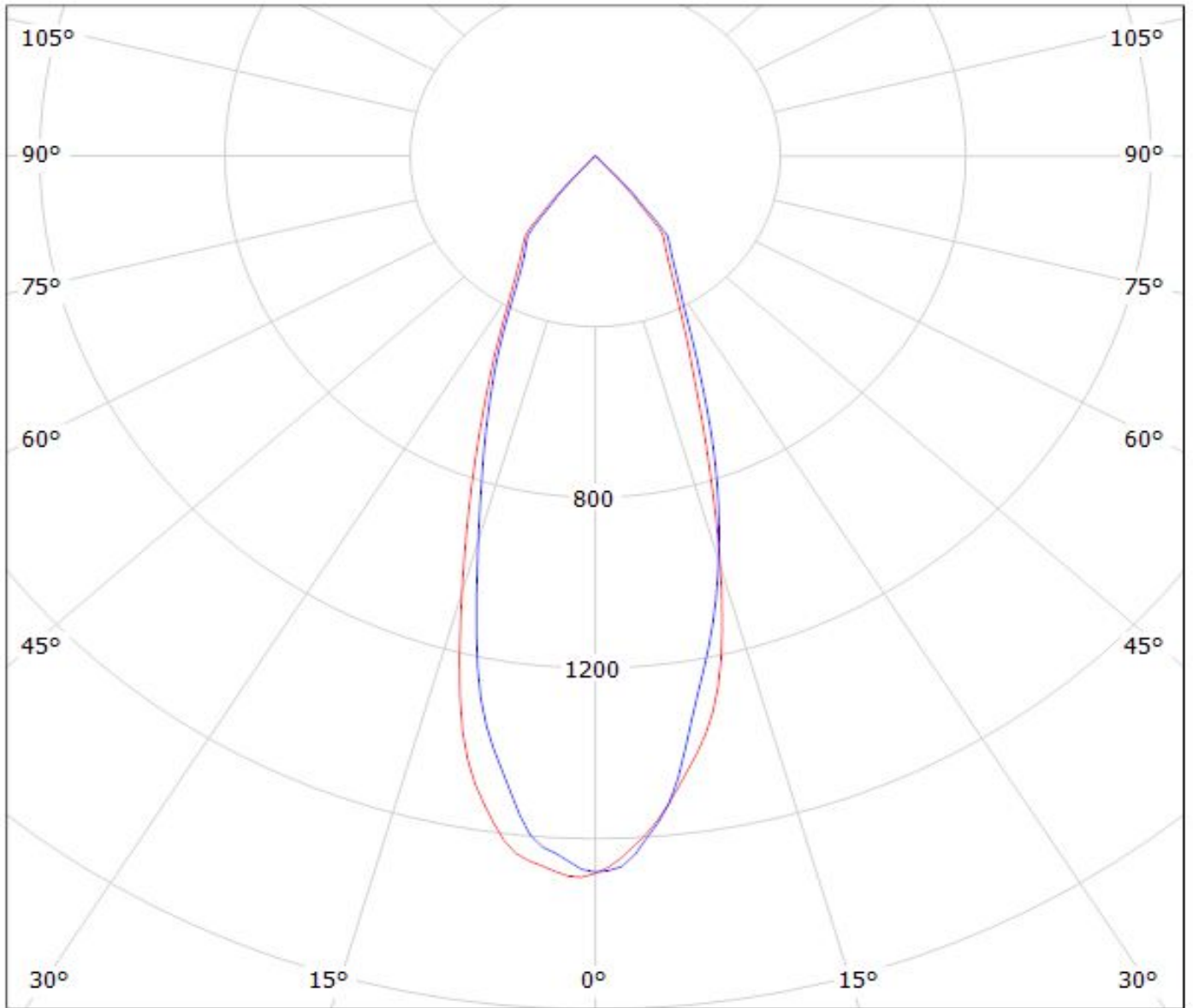

cd/klm

$\eta = 88\%$

— C0 - C180

— C90 - C270

Luminaire: LEDIL OY CN12485_MIRELLA-50-W-DL_(OstarLighting+) Eff.82.1
Lamps: 1 x Ostar Lighting+ (268.9lm@250mA)

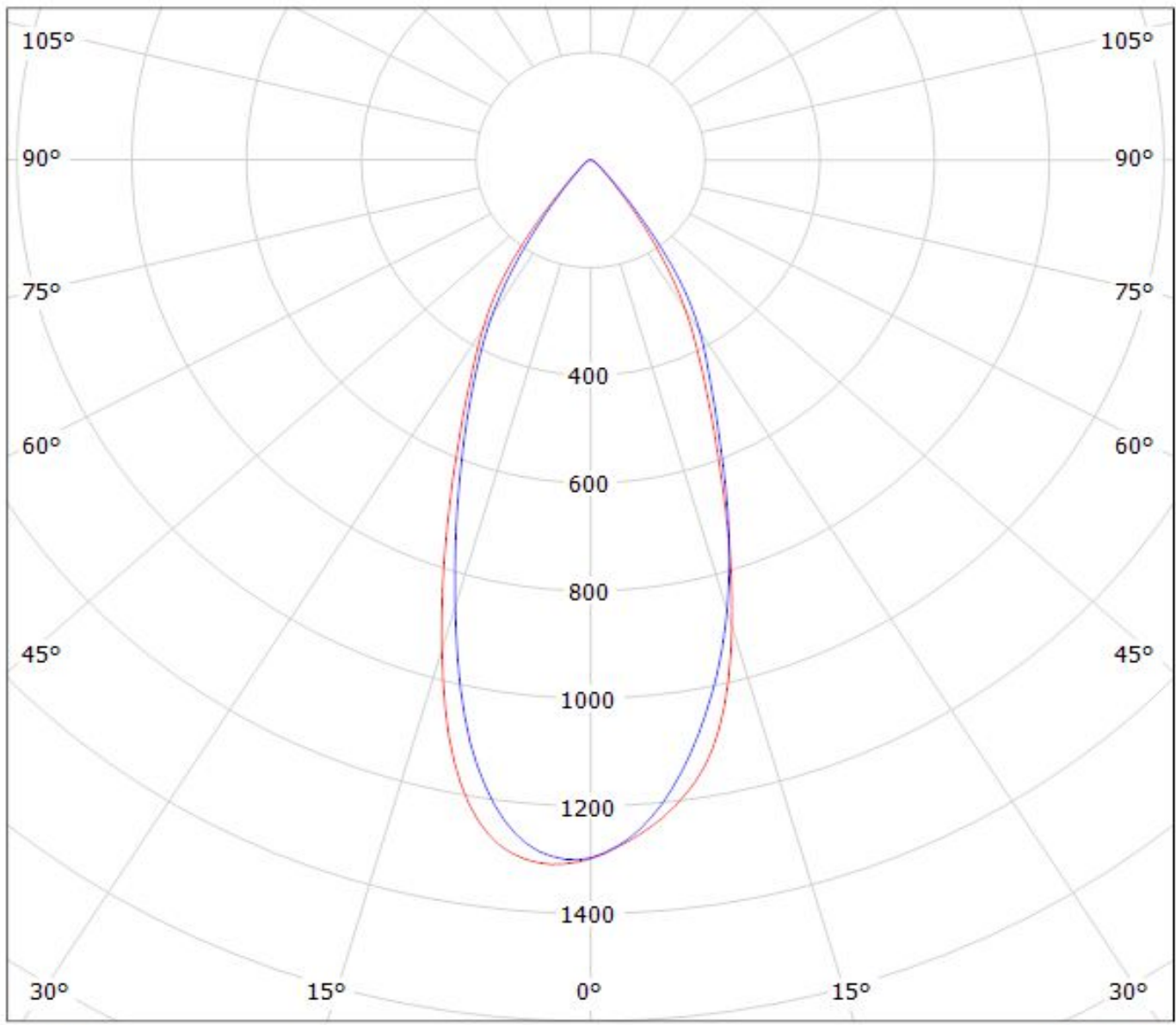

cd/klm

— C0 - C180 — C90 - C270

$\eta = 82\%$