

DRAWING FOR REFERENCE: This is subject to change without notice
05/31/2013

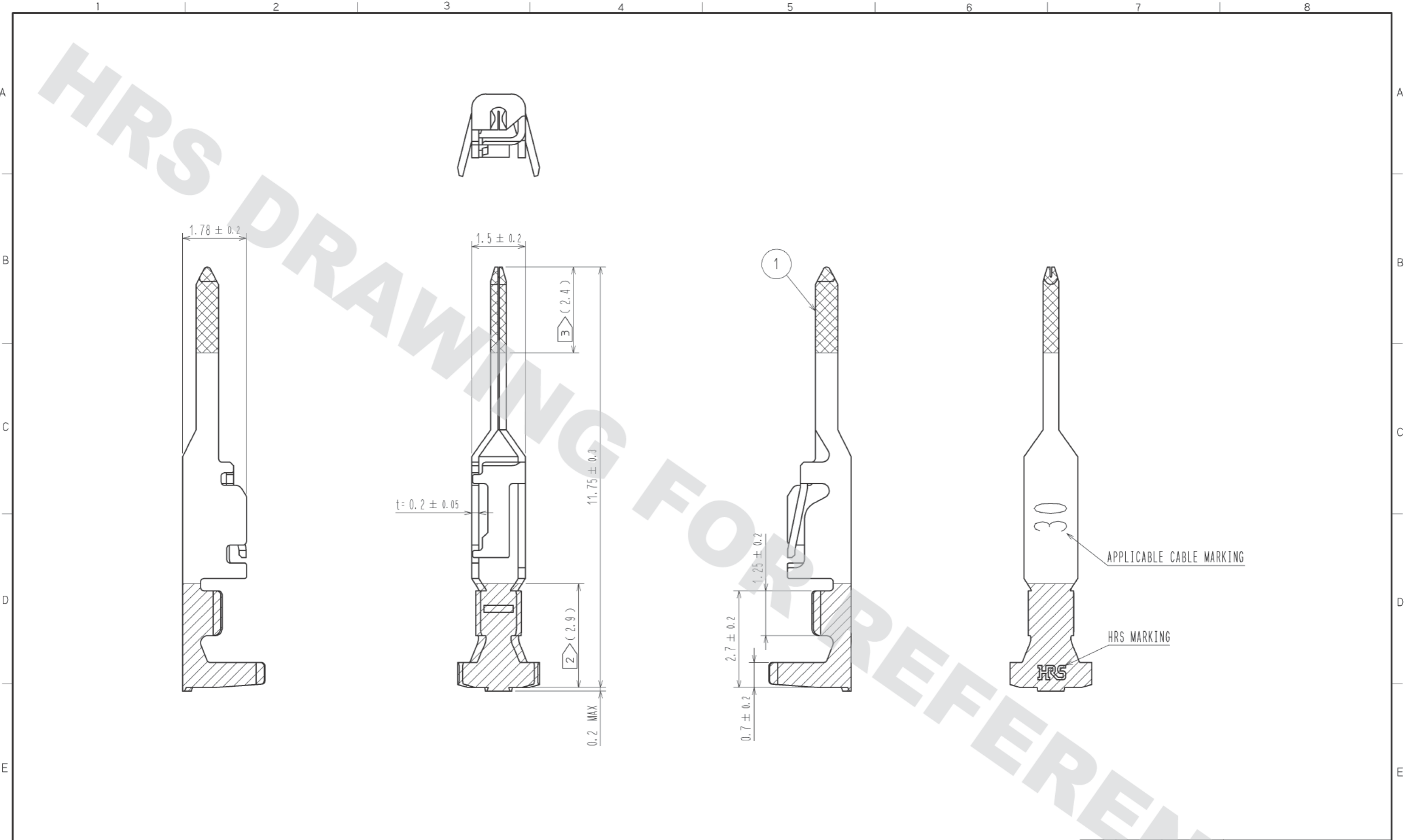

NOTE 1. 1PACK:100 CONTACTS
 2 TIN PLATING AREA.
 3 GOLD PLATING AREA.
 4. THE DIMENSIONS IN PARENTHESIS ARE FOR REFERENCE.

NO. 1		MATERIAL PHOSPHOR BRONZE		FINISH . REMARKS CONTACT AREA : GOLD PLATING 0.2μm MIN BARREL AREA : TIN PLATING 1μm MIN OTHERS : NICKEL PLATING 0.5μm MIN		
UNITS mm		SCALE 10:1	COUNT △	DESIGNED	CHECKED	DATE
HRS HIROSE ELECTRIC CO., LTD.		APPROVED : KI. AKIYAMA	12.07.21	DRAWING NO. EDC3-345111-00		
		CHECED : MN. KENJO	12.07.21	PART NO. DF62-EP30PCA		
		DESIGNED : TO. HORII	12.07.20	CODE NO. CL544-0531-2-00		
		DRAWN : TO. HORII	12.07.20			△ 1/1