

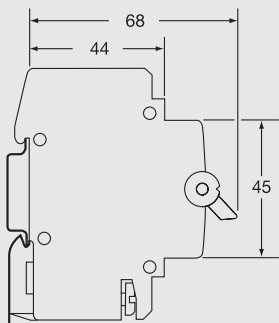

Miniature circuit breakers 6kA type B SP	3.2
Miniature circuit breakers curve B,C&D 10kA and 15kA	3.3
Auxiliaries and accessories	3.5
RCCB add-on blocks	3.6
Miniature circuit breakers 80-125A	3.8
Single pole & switch neutral devices	3.15
2 & 4 pole RCCBs	3.16
RCCB auxiliaries	3.17
RCBO single pole	3.18
RCBO single pole and switched neutral	3.19
HRC fuse carriers and fuses	3.20
Motor starters	3.21
Earth fault relays	3.22
Earth fault relay - torroids	3.23
Surge protection devices	3.24
125A frame MCCBs	3.26
125A frame MCCBs accessories and auxiliaries	3.27
250A frame MCCBs	3.28
250A frame MCCBs accessories and auxiliaries	3.29
400A frame MCCBs	3.30
400A frame MCCBs accessories and auxiliaries	3.30
630A frame MCCBs	3.31
630A frame MCCBs accessories and auxiliaries	3.31

Miniature Circuit Breakers 6kA Type B SP - MTN



Description
Protection and control of circuits against overloads and short circuits.
• In domestic installations.

Technical data
Type B tripping characteristics complies with BS EN 60-898.
Calibration temperature 30°C.
Breaking capacity: 6,000A.
Voltage rating: 230-400V.
Current rating: 6-63A.
Electrical endurance: 20,000

Operations
Connection capacity
Rigid conductor 25mm²
Flexible conductor 16mm²

Designation	In/A	Width in 17.5mm	pack qty.	Cat Ref.
Single pole MCB	6	1	12	MTN106
	10	1	12	MTN110
	16	1	12	MTN116
	20	1	12	MTN120
	25	1	12	MTN125
	32	1	12	MTN132
	40	1	12	MTN140
	50	1	12	MTN150
	63	1	12	MTN163



MTN106



MTN140

Miniature Circuit Breakers

Curve B,C & D : BS EN 60898 : 10 kA and BS EN 60947-2 : 15kA

NBNxxxA : "B" Curve
 NCNxxxA : "C" Curve
 NDNxxxA : "D" Curve

In 0.5 to 63A
 Un : 230V-400V

Will accept accessories
 (See page 3.5)

Description
 These MCBs allow you to ensure

- Protection of circuits against short circuits
- Protection of circuits against overload current
- Control
- Isolation

Adapted in commercial and industrial electrical distribution.

Control
 With a fast system of closing, we increase the withstand of contacts on all types of loads.

Isolation
 The state of isolation is clearly indicated by the "OFF" mechanical position on the toggle with the green colour

Connection capacity

- 25mm² flexible conductor
- 35mm² rigid conductor

Fool proof terminal design

Complies with:

- BS EN 60898
- BS EN 60947-2



NCN116A

Designation	In/A	Width in 17.5mm	Pack qty	Cat ref.		
				"B" Curve	"C" Curve	"D" Curve
Single Pole MCB 	0.5	1	12		NCN100A	NDN100A
	1	1	12		NCN101A	NDN101A
	2	1	12		NCN102A	NDN102A
	3	1	12		NCN103A	NDN103A
	4	1	12		NCN104A	NDN104A
	6	1	12	NBN106A	NCN106A	NDN106A
	10	1	12	NBN110A	NCN110A	NDN110A
	13	1	12	NBN113A	NCN113A	NDN113A
	16	1	12	NBN116A	NCN116A	NDN116A
	20	1	12	NBN120A	NCN120A	NDN120A
	25	1	12	NBN125A	NCN125A	NDN125A
	32	1	12	NBN132A	NCN132A	NDN132A
	40	1	12	NBN140A	NCN140A	NDN140A
50	1	12	NBN150A	NCN150A	NDN150A	
63	1	12	NBN163A	NCN163A	NDN163A	



NCN216A

Double Pole MCB 	0.5	2	6		NCN200A	NDN200A
	1	2	6		NCN201A	NDN201A
	2	2	6		NCN202A	NDN202A
	3	2	6		NCN203A	NDN203A
	4	2	6		NCN204A	NDN204A
	6	2	6	NBN206A	NCN206A	NDN206A
	10	2	6	NBN210A	NCN210A	NDN210A
	13	2	6	NBN213A	NCN213A	NDN213A
	16	2	6	NBN216A	NCN216A	NDN216A
	20	2	6	NBN220A	NCN220A	NDN220A
	25	2	6	NBN225A	NCN225A	NDN225A
	32	2	6	NBN232A	NCN232A	NDN232A
	40	2	6	NBN240A	NCN240A	NDN240A
	50	2	6	NBN250A	NCN250A	NDN250A
	63	2	6	NBN263A	NCN263A	NDN263A

Miniature Circuit Breakers

Curve B,C & D : BS EN 60898 : 10 kA and BS EN 60947-2 : 15kA

NBNxxxA : "B" Curve
 NCNxxxA : "C" Curve
 NDNxxxA : "D" Curve

In 0.5 to 63A
 Un : 230V-400V

Will accept accessories
 (See page 3.5)

Description
 These MCBs allow you to ensure

- Protection of circuits against short circuits
- Protection of circuits against overload current
- Control
- Isolation

Adapted in commercial and industrial electrical distribution.

Control
 With a fast system of closing, we increase the withstand of contacts on all types of loads.

Isolation
 The state of isolation is clearly indicated by the "OFF" mechanical position on the toggle with the green colour

Connection capacity

- 25mm² flexible conductor
- 35mm² rigid conductor

Fool proof terminal design

Complies with:

- BS EN 60898
- BS EN 60947-2

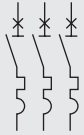

NCN316A

Designation	In/A	Width in ■ 17.5mm	Pack qty	Cat ref.			
				"B" Curve	"C" Curve	"D" Curve	
Triple Pole MCB 	0.5	3	4		NCN300A	NDN300A	
	1	3	4		NCN301A	NDN301A	
	2	3	4		NCN302A	NDN302A	
	3	3	4		NCN303A	NDN303A	
	4	3	4		NCN304A	NDN304A	
	6	3	4		NBN306A	NCN306A	NDN306A
	10	3	4		NBN310A	NCN310A	NDN310A
	13	3	4		NBN313A	NCN313A	NDN313A
	16	3	4		NBN316A	NCN316A	NDN316A
	20	3	4		NBN320A	NCN320A	NDN320A
	25	3	4		NBN325A	NCN325A	NDN325A
	32	3	4		NBN332A	NCN332A	NDN332A
	40	3	4		NBN340A	NCN340A	NDN340A
	50	3	4		NBN350A	NCN350A	NDN350A
63	3	4		NBN363A	NCN363A	NDN363A	



NCN416A

Four Pole MCB 	0.5	4	3		NCN400A	NDN400A	
	1	4	3		NCN401A	NDN401A	
	2	4	3		NCN402A	NDN402A	
	3	4	3		NCN403A	NDN403A	
	4	4	3		NCN406A	NDN404A	
	6	4	3		NBN406A	NCN406A	NDN406A
	10	4	3		NBN410A	NCN410A	NDN410A
	13	4	3		NBN413A	NCN413A	NDN413A
	16	4	3		NBN416A	NCN416A	NDN416A
	20	4	3		NBN420A	NCN420A	NDN420A
	25	4	3		NBN425A	NCN425A	NDN425A
	32	4	3		NBN432A	NCN432A	NDN432A
	40	4	3		NBN440A	NCN440A	NDN440A
	50	4	3		NBN450A	NCN450A	NDN450A
63	4	3		NBN463A	NCN463A	NDN463A	

Auxiliaries and Accessories for Devices - NBN, NCN, NDN, 10kA MCBs

All auxiliaries are common to both single and multi-pole 10kA circuit breakers and RCCBs

Connection capacity
4mm² flexible
6mm² rigid

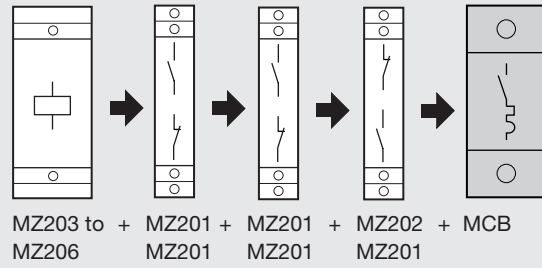

Protection Devices

Designation	Description	Width in 17.5mm	Pack qty.	Cat Ref.
-------------	-------------	-----------------	-----------	----------



MZ201

Auxiliary contacts 5A - 230V~.	1NO +1NC allows remote indication of main contact status	1/2	1	MZ201
-----------------------------------	--	-----	---	--------------

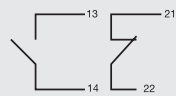

MZ204

Auxiliary contacts and alarm indication	Allows indication of whether MCB has been turned off or tripped	1/2	1	MZ202
---	---	-----	---	--------------



Shunt trip	Allows remote tripping of the associated device. Operation of the coil is indicated by a flag on the product fascia 230V - 415Vac 110V - 130Vdc	1	1	MZ203
------------	---	---	---	--------------



	24 - 48Vac 12 - 48Vdc	1	1	MZ204
--	--------------------------	---	---	--------------



MZ205

Under voltage release	Allows MCB to be closed only when voltage is above 85% of Un. MCB will automatically trip when voltage falls to between 70-35% of Un. Operation of the coil is indicated by a flag on the product fascia 230Vac 48Vdc	1 1	1 1	MZ206 MZ205
-----------------------	---	--------	--------	------------------------------

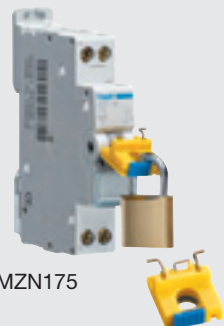

MZN175

Locking kit for the toggle of the device. supplied without padlock.	This allows locking of the device toggle in the on/off position. will accept two padlocks with hasps of 4.75mm diameter max.		2	MZN175
---	--	--	---	---------------

RCCB add-on blocks for MCB devices - NBN, NCN, NDN

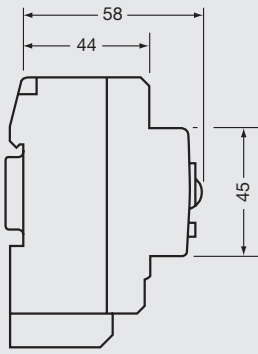

Description

These products provide earth fault protection when associated with the 10kA (types NB,NC,ND) range of MCBs. They are designed to be fitted to the right hand side of 2 and 4 pole MCBs and the completed unit provides protection against:-

- overload
- short circuit
- earth faults

Technical data

3 non adjustable sensitivities
 30, 100 & 300mA
 nominal voltage 230 - 400V
 protection against nuisance tripping.

2 pole = 2 ■ 4 pole = 3 ■

BS EN 61009 appendix G

■ Selective (time delay)
 versions are available in 100 & 300mA

Connection capacity

16mm² flexible
 25mm² rigid

All devices have a test facility.

Designation

Sensitivity
I_{Δn}

I_n/A

Width in ■
17.5mm

Pack
qty.

Cat Ref.
standard

2 pole RCCB add-on blocks

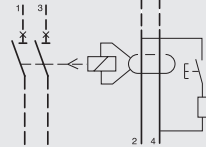

time delayed ■ 100mA

63A

2

1

BN264

time delayed ■ 300mA

63A

2

1

BP264

4 pole RCCB add-on blocks

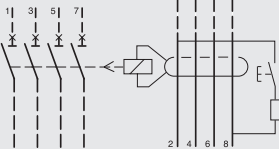

time delayed ■ 100mA

63A

3

1

BN464

time delayed ■ 300mA

63A

3

1

BP464



2 pole MCB and add on block showing unique sliding connection feature

The new range of modular protection devices ranging from 80 to 125A re-inforces Hagers commitment to new product development in protection solutions for OEMs and commercial buildings.

Especially designed to provide :

- Protection as main incomer for sub distribution
- Protection of loads directly supplied by a distribution board.

Offering benefits focussed on safety, ease of installation and use friendliness, this is another example by Hager of continuous investment to develop products for the future.

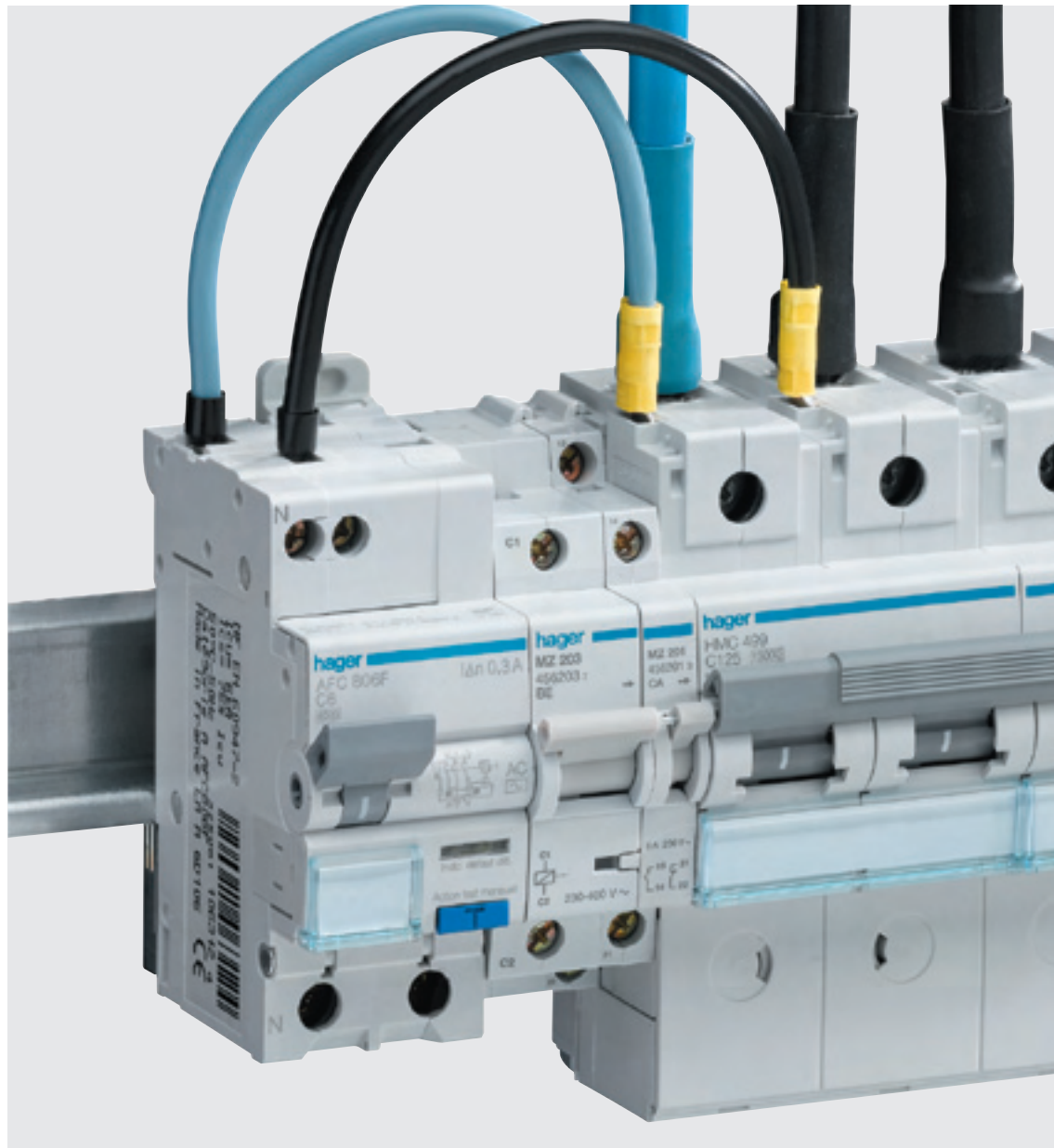

The HM range of MCBs and add-on blocks benefit from the new exclusive "cage connection".

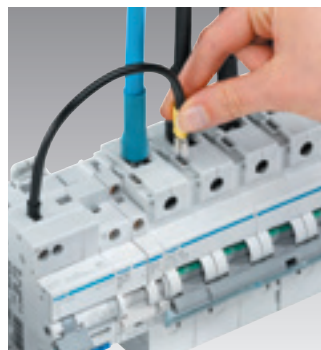

The connection of auxiliaries becomes easy, thanks to the new "Fast on" connection terminals provided on the top and bottom of the MCBs. This provides a quick and easy solution to feed auxiliaries such as shunt trip coil, UV release etc.

- Capacity:
- 1.5 to 6mm²
 - Maximum current 6A

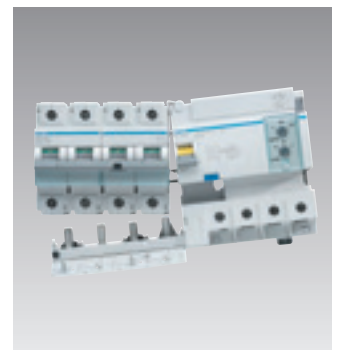
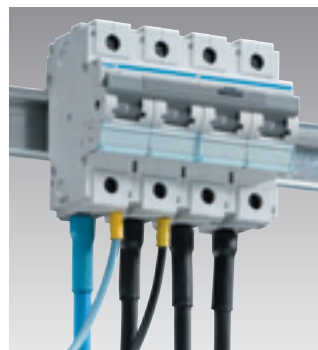

Across the range, the assembly of the add-on block is carried out in three simple steps.

1. Assembly
2. Connection
3. Locking

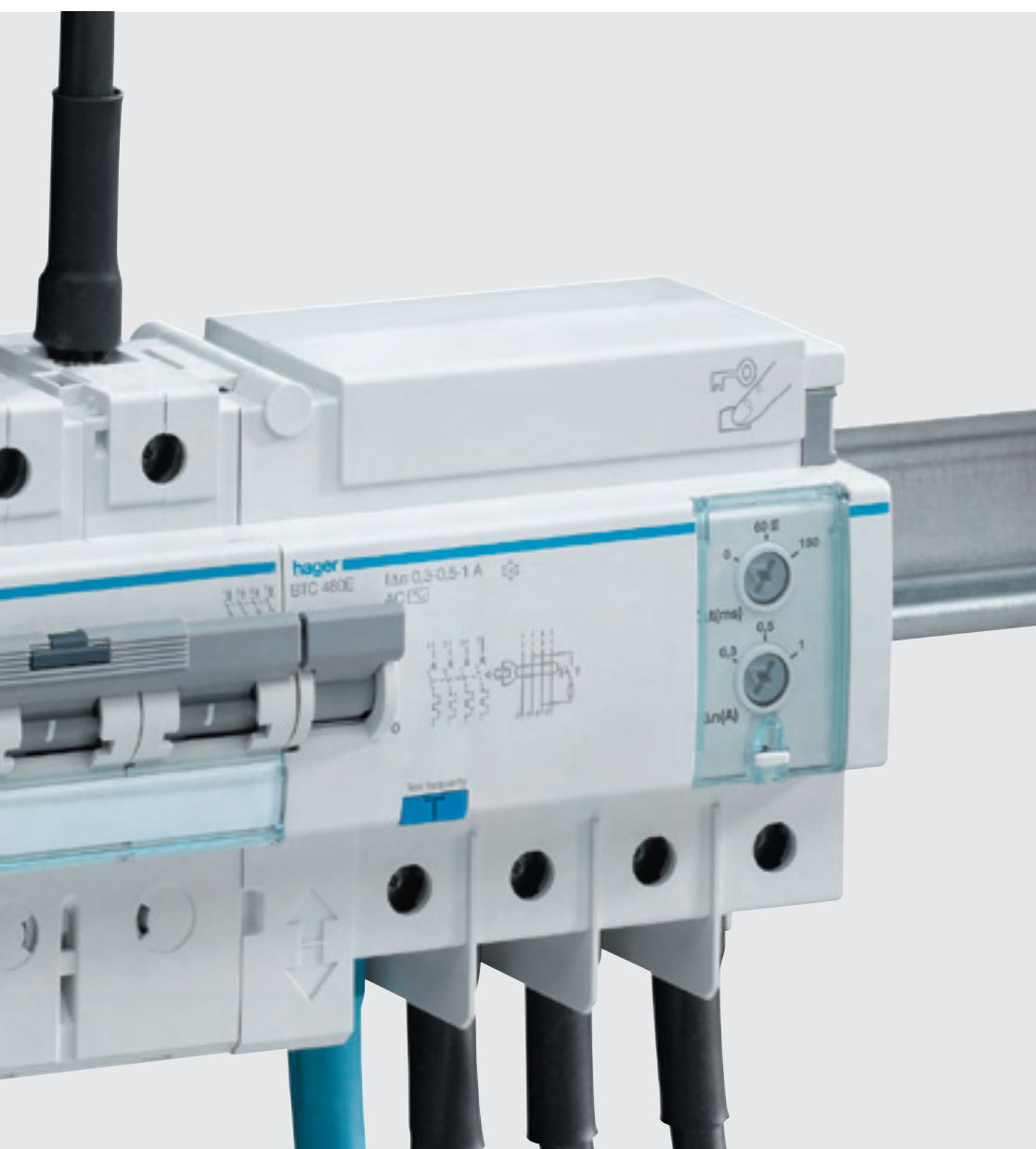

Miniature Circuit Breakers 80-125A	3.10
HMF "C" Curve	3.11
HMF "C" Curve 15kA	3.12
HMD "D" Curve 15kA	3.13
RCD Add-on Blocks type AC	3.14



The add-on blocks are available in fixed and adjustable versions. In adjustable version, the sensitivity and the time delay can be adjusted, even when connected.



The RCD Add on block is equipped with locating pins which helps to secure the tightening of the bottom terminals to the circuit breaker. The cover cannot be closed if the terminals are not tightened correctly



The MCBs can lock in "OFF" position by the integrated locking facility on the toggle.

This lock allows inserting a 2,5 to 3,5mm plastic cable tie where you can fit a warning card if necessary (delivered with each product).

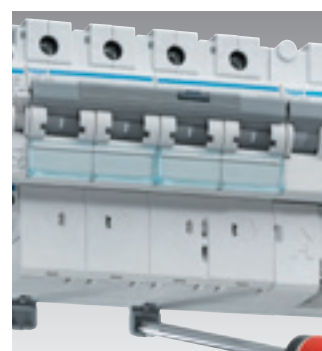

The DIN rail clips of the circuit breaker unit and add-on-block facilitate its mounting. They are easily accessible with a screwdriver.

Miniature Circuit Breakers 80-125A

Thermal magnetic circuit breakers

Curves "C" - "D"

In 80 to 125 A

These circuit breakers are intended for the protection of the circuits against overloads and short circuits.

HMC curve "C"
15 kA

(BS EN 60898-1)
15 kA for 80 - 100 - 125 A :
BS EN 60947-2
Width 1.5 mod/pole

HMD curve "D"
15 kA

(BS EN 60898-1)
15 kA for 80 - 100 - 125 A :
BS EN 60947-2
Width 1.5 mod/pole

HMF curve "C"
10 kA

(BS EN 60898-1)
10 kA for 80 - 100 - 125 A :
BS EN 60947-2
width 1.5 mod/pole

Series HMC, HMD, HMF :

These circuit breakers are equipped with reinforced screw cages.

A label holder is integrated under the toggle to ensure the location of the product.

The "OFF" position is clearly shown by a green indicator below the toggle.

Suitable for isolation (according to BS EN 60947-2) : the isolation of the circuit breakers is indicated by a green indicator on the toggle.

These circuit breakers have quick closing : fast and simultaneous closing of the contacts, independent of the handling speed.

This increases the life of the circuit breaker whatever the type of load.

Nominal voltage : 230/415 V ~
calibration setting :30 °C
(BS EN 60898-1)
insulation voltage: 500 V

Options :

- auxiliary :
- to visualise the state ON or OFF of the circuit breaker,
- to ON/OFF remotely the circuit breaker

locking mechanism

terminal covers and phase separators

RCD add-on blocks

Series HMC, HMD,

Mounting capability :
bistable DIN-rail latches (2 positions) upstream and downstream facilitate the mounting of the circuit breakers on the DIN-rail.

Terminals with tightening compensation.

These circuit breakers are equipped with screw cages with tightening compensation, (reinforcement cage cable holding jaws). These elements contribute to an effective cable tightening over time.

These circuit breakers are equipped with cable terminals of type "fast on" upstream and downstream to feed an auxiliary low voltage circuit (indicating lights, auxiliary control...) Max. current 6A max. cable csa - 6 mm²

Lockable toggle
MCB can be locked in "Off" position by the integrated locking facility on the toggle. This lock allows to insert a 2.5-3.5mm plastic cable tie where you can fit a warning card if necessary and allows a safer working environment for all personnel.

RCD Add-on blocks, simple, quick, adjustable and fixed

1. Assembly
2. Connection
3. Locking

the assembly of the add-on block is carried out very quickly and easily. Simple and fast : it is a Hager innovation. add-on blocks 125A are available in fixed version and adjustable version.

Model	Icc/Curve	Accessories	Fast-on connection	Tightening comp. system	Lockable handle	Front product labelling
HMF	10kA / C	YES	NO	NO	NO	YES
HMC / HMD	15kA / C, D	YES	YES	YES	YES	YES

Miniature Circuit Breakers 80-125A
HMF : "C" - 10 kA

Curves "C" **10 kA**
 (BS EN 60898-1)
10 kA
 (BS EN 60947-2)

In 80 to 125 A

Tripping curves
 "C" magnetic setting between
 5 and 10 In.

Use :
 Commercial and
 industrial applications

Connection capacity
 • 35mm² flexible wire (50mm²
 possible with some cable
 end-caps),
 • 70mm² rigid wire

KEMA approved according to
 BS EN 60898-1, BS EN 947-2
 standards.

<i>Designation</i>	<i>In/A</i>	<i>Width in ■ 17.5 mm</i>	<i>Cat Ref. "C" Curve</i>
Circuit breakers 1 pole	80	1.5	HMF180T
	100	1.5	HMF190T
	125	1.5	HMF199T
Circuit breakers 2 poles	80	3	HMF280T
	100	3	HMF290T
	125	3	HMF299T
Circuit breakers 3 poles	80	4.5	HMF380T
	100	4.5	HMF390T
	125	4.5	HMF399T
Circuit breakers 4 poles	80	6	HMF480T
	100	6	HMF490T
	125	6	HMF499T



HMF199T



HMF299T



HMF399T

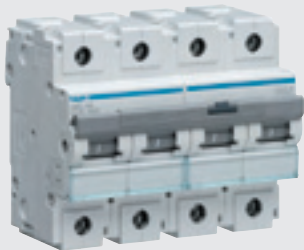

HMF499T

Miniature Circuit Breakers 80-125A
HMC : "C" - 15 kA

Curves "C" **15 kA**
 (BS EN 60898-1)
15 kA
 (BS EN 60947-2)

In 80 to 125 A

Tripping curves
 "C" magnetic setting between
 5 and 10 In.

Use :
 Commercial and
 industrial applications

Connection capacity
 • 35mm² flexible wire (50mm²
 possible with some cable
 end-caps),
 • 70mm² rigid wire

KEMA approved according to
 BS EN 60898-1,BS EN 947-2
 standards.



HMC180T



HMC280T



HMC380T

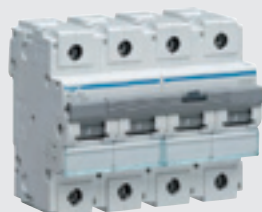

HMC480T

<i>Designation</i>	<i>In/A</i>	<i>Width in ■ 17.5 mm</i>	<i>Cat Ref. "C" Curve</i>
Circuit breakers 1 pole	80	1.5	HMC180T
	100	1.5	HMC190T
	125	1.5	HMC199T
Circuit breakers 2 poles	80	3	HMC280T
	100	3	HMC290T
	125	3	HMC299T
Circuit breakers 3 poles	80	4.5	HMC380T
	100	4.5	HMC390T
	125	4.5	HMC399T
Circuit breakers 4 poles	80	6	HMC480T
	100	6	HMC490T
	125	6	HMC499T

Miniature Circuit Breakers 80-125A HMD : "D" - 15 kA

Curves "D" **15 kA**
(BS EN 60898-1)
15 kA
(BS EN 60947-2)

In 80 to 125 A

Tripping curves
"D" magnetic setting between
10 and 20 In.

Use :
Commercial and
industrial applications

Connection capacity
• 35mm² flexible wire (50mm²
possible with some cable
end-caps),
• 70mm² rigid wire

KEMA approved according to
BS EN 60898-1, BS EN 947-2
standards.

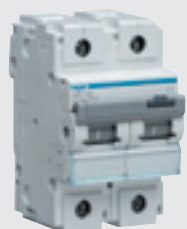

HMD299T



HMD399T



HMD499T

<i>Designation</i>	<i>In/A</i>	<i>Width in ■ 17.5 mm</i>	<i>Cat Ref. "C" Curve</i>
Circuit breakers 1 pole	80	1.5	HMD180T
	100	1.5	HMD190T
	125	1.5	HMD199T
Circuit breakers 2 poles	80	3	HMD280T
	100	3	HMD290T
	125	3	HMD299T
Circuit breakers 3 poles	80	4.5	HMD380T
	100	4.5	HMD390T
	125	4.5	HMD399T
Circuit breakers 4 poles	80	6	HMD480T
	100	6	HMD490T
	125	6	HMD499T

Accessories for Circuit Breakers



MZN 130



MZN 131

<i>Designation</i>	<i>Characteristics</i>	<i>Cat Ref.</i>
Terminal covers / Screw cap	Allows to cover connection terminals, screws of circuit breakers. The screw covers can be sealed.	MZN130
Phase separator	1 set of 3 phase separators	MZN131

RCD add-on blocks type AC for circuit breakers HMC, HMD, HMF

RCD add-on blocks for circuit breakers HMC, HMD, HMF.

Fixed :

- **high sensitivity 30 mA** instantaneous
- **low sensitivity 300 mA** - instantaneous.

Settings :

- sensitivity $I\Delta n$ 0,3 - 0,5 - 1 A ...
- delay  Δt 0 - 60 - 150 ms.

These devices are intended to be fixed on the right side of the circuit breakers to form differential circuit breakers from 80 to 125A, two, three or four-pole.

This "circuit breaker + block" ensures, in addition to the overload and short circuit protection, the protection of the installations against the insulation defects (300mA and 1A) and the protection of the people against the direct contacts (30mA) and indirect (300mA).

Adjustable blocks :

the setting is done by actuating the thumbwheel in front face. The setting thumbwheels are protected by a transparent sealable cover.

Disassembly :

the bistable latch (2 positions) facilitate the assembly or disassembly by the bottom of the "circuit breaker + block."

These RCD add-on blocks exist in version AC and in version A-HI.

Version AC  :

the add-on blocks are protected against unexpected tripping caused by the transitory leakage currents : lightning, capacitive loading.

High Immunity :

The products with "reinforced immunity" reduce the unexpected tripping when they protect equipment generating disturbances (micro-processing, electronic ballast,...)

The earth fault is indicated when the handle is in lower position (yellow colour).
Test button for earth fault check.

Tightening compensation cages

These circuit breaker blocks are equipped with screw cages with tightening compensation, reinforcement arch and cable holding jaws. These elements contribute to an effective tightening over time.







Connection capacity :

- 35mm² flexible connection (50° possible with some terminals),
- 70mm² rigid connection.

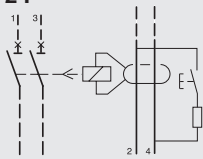
Assembly and disassembly facilitated by the drawer assembly system. The terminal cover is dependent of the add-on block. It is provided with keying systems avoiding the omission of terminal tightening downstream of the circuit breaker. .

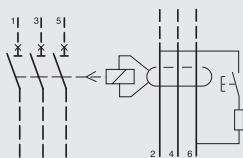
Nominal voltage : -15 +10 %
2 poles : 230 V
three and four-pole : 230/400 V
test button : 230/400 V.

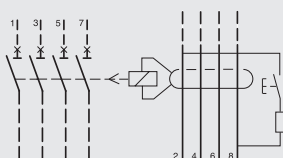
In conformity with the requirements of the appendix G of the BS EN 61009-1.
In conformity with the requirements of standard BS EN 60947-2.

Designation	Sensitivity fixed / adjustable $I\Delta n$	I_n / A	Width in ■ 17,5 mm	Cat Ref. add-on blocks AC
Add-on blocks 2 poles 2 P 	fixed 30 mA	125	6	BDC280E
	adjustable 0,3 - 0,5 - 1 A  0 - 60 - 150 ms	125	6	BTC280E
Add-on blocks 3 poles 3 P 	fixed 30 mA	125	6	BDC380E
	adjustable 0,3 - 0,5 - 1 A  0 - 60 - 150 ms	125	6	BTC380E
Add-on blocks 4 poles 4 P 	fixed 30 mA	125	6	BDC480E
	fixed 300 mA	125	6	BFC480E
	adjustable 0,3 - 0,5 - 1 A  0 - 60 - 150 ms	125	6	BTC480E

association circuit breaker + add-on block 4 poles adjustable

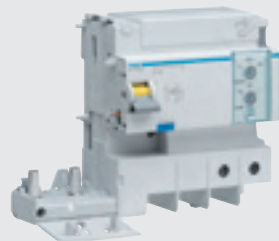
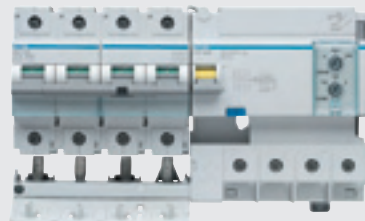

BTC 280E



BDC 480E

Single Pole and Switched Neutral (SPSN) Devices - MCB and Fuse Carrier

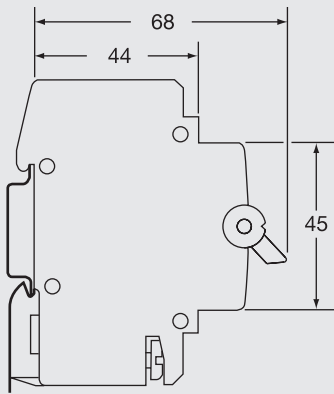

Description
MCBs
Protection and control of circuits against overloads and short circuits.

Technical data
Type C tripping characteristics
Complies with BS EN 60-898
Calibration temperature 30°C
Breaking capacity - 6000A
Voltage rating - 230VAC

Connection capacity
Rigid 16mm²
Flexible 10mm²

Description
Fuse carriers
Protection and control of circuits against overloads and short circuits

Technical data
Characteristics type (fuse) gF
Interruption capacity - 10-20A 4000A
25 & 32A - 6000A
Voltage rating - 250VAC
Connection capacity
Rigid 16mm²
Flexible 10mm²

Protection
Devices

Designation	Current (A)	Width in ■	Pack qty	Cat Ref.
MCB				
Single Pole & Switched Neutral	6	1	12	MLN706A
	10	1	12	MLN710A
	16	1	12	MLN716A
	20	1	12	MLN720A
	32	1	12	MLN732A
	40	1	12	MLN740A
Fuse Carrier				
Single Pole & Switched Neutral without fuse fitted.	10	1	12	L12401
	16	1	12	L12501
	20	1	12	L12601
	25	1	12	L12701
	32	1	12	L12801
Spare fuse type gF				
10A - 8.5 x 23mm	10		10	LF138
16A - 10.3 x 25.8mm	16		10	LF139
20A - 8.5 x 31.5	20		10	LF140
25A - 10.3 x 31.5mm	25		10	LF141
32A - 10.3 x 38mm	32		10	LF142
Single module blank			25	VAS01
Shrouds busbar & blanks spare ways				
Locking kit			2	MZN175
For the toggle of the device. Supplied without padlock. For use with MCCB's.				
This allows locking of the device toggle in the on/off position. Will accept two padlocks with hasps of 4.75mm diameter max.				



MLN710A



MLN740A

2 & 4 Pole RCCBs

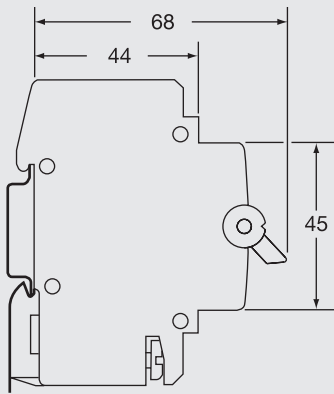

Description
To open a circuit automatically in the event an earth fault between phase and earth, and/or neutral and earth. A wide range of current ratings and sensitivities are available. Suitable for domestic, commercial and industrial applications.

Technical data
Complies with BS EN 61008, IEC1008

Sensitivities (Fixed)
10, 30, 100, 300mA & 100 and 300mA time delayed.

Terminal capacities
16-63A Rigid 25mm²
Flexible 16mm²
80&100A Rigid 50mm²
Flexible 35mm²

Features
Positive contact indication is provided by the rectangular flag indicator
Red = Closed
Green = Open
Indication of trip is provided by the oval flag indicator

Yellow = Tripped.
All RCCBs have trip free mechanisms and can be padlocked either on or off.

Operating temperature range
- 5 to 40°C type AC
- 25 to 40°C type A

Operating voltage
2P: 110-230Vac
4P: 230 - 400Vac

Width in 17.5mm modules ■
2P - 2 ■
4P - 4 ■



CDC225U



CDC263U

<i>Sensitivity type AC</i>	<i>Current rating</i>	<i>Pack qty.</i>	<i>Cat Ref. 2 Pole</i>	<i>Cat Ref. 4 Pole</i>
10mA	16A	1	CCC216U	
30mA	25A	1	CDC225U	CDC425U
30mA	40A	1	CDC240U	CDC440U
30mA	63A	1	CDC263U	CDC463U
30mA	80A	1	CD280U	CD480U
30mA	100A	1	CD284U	CD484U
100mA	25A	1	CEC225U	CEC425U
100mA	40A	1	CEC240U	CEC440U
100mA	63A	1	CEC263U	CEC463U
100mA	80A	1	CE280U	CE480U
100mA	100A	1	CE284U	CE484U
300mA	25A	1	CFC225U	CFC425U
300mA	40A	1	CFC240U	CFC440U
300mA	63A	1	CFC263U	CFC463U
300mA	80A	1	CF280U	CF480U
300mA	100A	1	CF284U	CF484U
Time delayed				
100mA	100A	1	CN284U	CN484U
300mA	100A	1	CP284U	CP484U
Type A DC sensitive				
10mA	16A	1	CCA216U	
30mA	25A	1	CDA225U	CDA425U
30mA	40A	1	CDA240U	CDA440U
30mA	63A	1	CDA263U	CDA463U
Accessories				
Terminal covers	16A-63A	1	CZN005	CZN006
	80A-100A	1	CZ007	CZ008

RCCB
- Auxiliaries

Configurations
 For technical details see page 3.38.

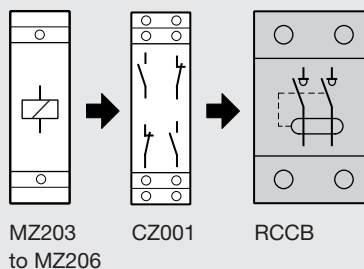

Protection
Devices

Designation	Description	Width in 17.5mm	Pack qty.	Cat Ref.
Interface auxiliary Indicates the position of the associated RCCB On, Off, Tripped. Also acts as RCCB interface with standard MCB auxiliaries MZ203-MZ206	2NO 2NC 6A AC1 230V	1	1	CZ001
Shunt trip	Allows remote tripping of the associated device. Operation of the coil is indicated by a flag on the product fascia			
	230Vac - 400Vac	1	1	MZ203
	110V - 130Vdc			
	24 - 48Vac	1	1	MZ204
	12-48Vdc			
Under voltage release	Allows RCCB to be closed, only when voltage is above 85% of Un. RCCB will automatically trip when voltage falls to between 70-35% of Un (230V). Operation of the release is indicated by a flag on the product fascia.			
	230Vac	1	1	MZ206
	48Vdc	1	1	MZ205
Locking kit For the dolly of the device. Supplied without padlock.	This allows locking of the device dolly in the on/off position. Will accept two padlocks with hasps of 4.75mm diameter max.		2	MZN175



CZ201



MZ204



MZ205



MZN175

RCBO - Single Pole

Description

Compact protection devices which combine the overcurrent functions of an MCB with the earth fault functions of an RCCB in a single unit. A range of sensitivity and current ratings are available for use in domestic commercial and industrial applications

New insulated DIN clip on 10kA MCBs and 1 module RCBO

Technical data

Specification
Complies with BS EN61009, IEC1009
Sensitivities (fixed)
10mA and 30mA
Breaking capacity: 6kA

Terminal capacities

16mm² rigid,
10mm² flexible

Application

1 module devices provide a compact solution for installation in consumer units, Invicta 63Mk2 distribution boards.
These devices are 1 pole & solid neutral.

Operating voltage

127-230V AC

Flying neutral lead length:
700mm



AD110

Sensitivity mA	In/A	Width in ■ 17.5mm	Pack qty.	Cat Ref. Type B	Cat Ref. Type C
10mA	6A	1	1	AC104	AC119
10mA	16A	1	1	AC107	AC122
10mA	25A	1	1	AC109	AC124
10mA	32A	1	1	AC110	AC125
30mA	6A	1	1	AD104	AD119
30mA	10A	1	1	AD105	AD120
30mA	16A	1	1	AD107	AD122
30mA	20A	1	1	AD108	AD123
30mA	25A	1	1	AD109	AD124
30mA	32A	1	1	AD110	AD125
30mA	40A	1	1	AD111	AD126
30mA	45A	1	1	AD112	AD127
30mA	50A	1	1	AD113	AD128
100mA	16A	1	1	-	AE116Z
100mA	32A	1	1	-	AE132Z
10kA 30mA	6A	1	1	-	AD184
10kA 30mA	10A	1	1	-	AD185
10kA 30mA	16A	1	1	-	AD187
10kA 30mA	20A	1	1	-	AD188
10kA 30mA	25A	1	1	-	AD189
10kA 30mA	32A	1	1	-	AD190
10kA 30mA	40A	1	1	-	AD191

Locking kit

For the dolly of the device.
Supplied without padlock.

This allows locking of the device dolly in the on/off position.
Will accept two padlocks with hasps of 4.75mm diameter max.

MZN175

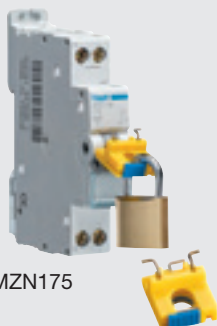

MZN175

RCBO - Single Pole and Switched Neutral

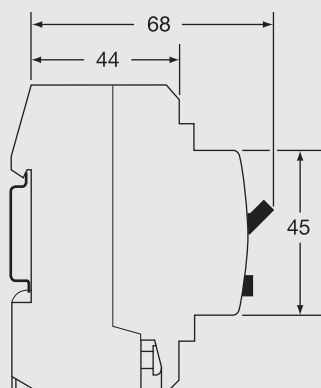

Description
Compact protection devices which provide MCB overcurrent protection and RCCB earth fault protection in a single unit. Complies with BS EN 61 009

Technical data
The units are available with current ratings of 6A, 10A, 16A, 20A, 25A, 32A and 40A. The device switches both the phase and neutral conductors. All ratings have 30mA earth fault protection. The units feature indicators which show whether tripping is due to an overcurrent or earth fault.

Operations
Mechanical life: 20,000 operations

Connection capacity
Rigid conductor 25mm²
Flexible conductor 16mm²

Breaking capacity: 6kA
Voltage rating: 110-230V.
Current rating: 6-40A.

Protection Devices



ADA932U

Designation	In/A	Width in 17.5mm	Pack qty.	Cat Ref. Type "B"	Cat Ref. Type "C"
RCBO tripping current (30mA) with flying 700mm lead for neutral connection.	6	2	1	ADA906U	ADA956U
	10	2	1	ADA910U	ADA960U
For use in consumer units and distribution boards only.	16	2	1	ADA916U	ADA966U
	20	2	1	ADA920U	ADA970U
	25	2	1	ADA925U	ADA975U
	32	2	1	ADA932U	ADA982U
	40	2	1	ADA940U	ADA990U

RCBO - Single Pole and Switched Neutral Type C 4.5kA



ADC806F

Designation	In/A	Width in 17.5mm	Pack qty.	Cat Ref. Type "C"
RCBO	6	2	1	ADC806F
All terminal version for cable in cable out applications e.g. local protection, caravan pitches, festive illuminations, street lighting.	10	2	1	ADC810F
	16	2	1	ADC816F
	20	2	1	ADC820F
	25	2	1	ADC825F
Note: Not for use in fixed busbar consumer units or distribution boards.	32	2	1	ADC832F

HRC fuse carriers - BS 1361 and BS 88

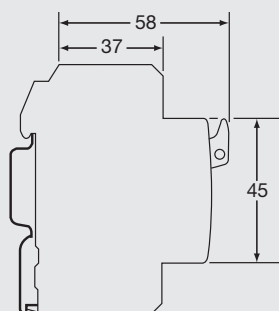

Description
Protection and control of circuits against overloads and short-circuits:

Technical data
• Fuse carriers suitable for fuses which fully comply with the dimensional, power loss, fusing factor, discrimination and time-current characteristic of BS 1361

Complies with BS 1361:1971
• Short-circuit rating:16.5kA (i.e. no further consideration of fault levels is necessary)
• Colour coded ratings
• Connection capacities:
Top:16 mm² flexible cable + busbar



L113 L115 L116 L118

Designation	Current rating (Amps)	Colour	Width in 17.5mm	Pack qty.	Cat Ref.
BS 1361 Fuse Carriers (Complete with cartridge fuse) for single phase applications	5 A – 230 V	White	1	12	L113
	15 A – 230 V	Blue	1	12	L115
	20 A – 230V	Yellow	1	12	L116
	30 A – 230 V	Red	1	12	L118
BS 1361 HRC Spare Cartridge Fuses	5 A (23 x 6.35 x 4.8mm)	White	-	50	L153
	15 A (26 x 10.32 x 6.4mm)	Blue	-	50	L155
	20 A (26 x 10.32 x 6.4mm)	Yellow	-	50	L156
	30 A (29 x 12.7 x 8mm)	Red	-	50	L158
	Spare fuse holder up to 20A		-	10	L147

BS 88 HRC fuse carriers and fuses

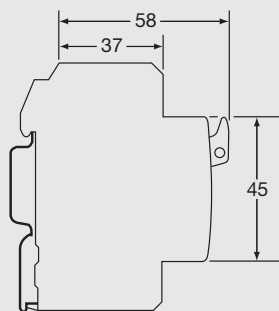

Fuse carrier 32 Amps max.
Protection and control of circuits against overloads and short-circuits:
• In three phase circuits

• Suitable for fuses which comply with BS 88:Part 1:1975 and with the standardised performance requirements for industrial fuse links specified in BS 88:Part 2

• Rating voltage: 415 V a.c. 250 V d.c.
• Fusing factor: class Q 1
• Rated breaking capacities: 80 kA at 415 V a.c. 40 kA at 250 V d.c.



L50145 and L176

Designation	Characteristics	Width in 17.5mm	Pack qty.	Cat Ref.
Fuse Carriers For BS 88 fuses (Supplied without fuse).	32 Amps max.	1	12	L50145
BS 88 cartridge fuses	2 A	-	20	L171
	4 A	-	20	L172
	6 A	-	20	L173
	8 A	-	20	L174
	10 A	-	20	L175
	16 A	-	20	L176
	20 A	-	20	L177
29 x 12.7 x 8mm	25 A	-	20	L178
	32 A	-	20	L179

Motor Starters

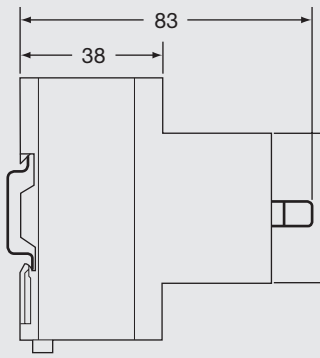

Description
To ensure localised control and protection of single and three phase motors.

Technical data

- Adjustable thermal relay
- AC3 utilisation category
- Connection capacity 2 conductors
max size: Flexible 1 to 4mm²
Rigid 1.5 to 6mm²

Options
Undervoltage release: MZ528N, MZ529N
Auxiliary contacts: MZ520N, MZ527N
Alarm contact: MZ527N

Complies with
IEC 947-1, IEC 947-2 (appropriate parts of)

Note: Please consult us for enclosure selection

Protection Devices

Designation	Current setting	standard power ratings of 3 phase motors 50/60Hz (AC3 category)		Width in 17.5mm	Pack qty.	Cat Ref.
		230V (kW)	400V (kW)			



MM501N

motor starters	0.1 - 0.16A				1	MM501N
	0.16 - 0.25A	-	0.06	2 1/2	1	MM502N
	0.25 - 0.4A	0.06	0.09	2 1/2	1	MM503N
	0.4 - 0.6A	0.09	0.12	2 1/2	1	MM504N
	0.6 - 1.0A	0.09	0.12	2 1/2	1	MM505N
	1.0 - 1.6A	0.25	0.55	2 1/2	1	MM506N
	1.6 - 2.5A	0.55	0.8	2 1/2	1	MM507N
	2.5 - 4A	0.8	1.5	2 1/2	1	MM508N
	4 - 6A	1.5	2.5	2 1/2	1	MM509N
	6 - 10A	2.5	4	2 1/2	1	MM510N
	10 - 16A	4	7.5	2 1/2	1	MM511N
	16 - 20A	5.5	9	2 1/2	1	MM512N
	20 - 25A	7.5	12.5	2 1/2	1	MM513N



MZ520N

Auxiliary contacts (Act as an indicating device to monitor the ON or OFF position)	1C + 1O	2A AC1 - 400V~ 3.5A AC1 - 230V~		1/2	1	MZ520N
--	---------	------------------------------------	--	-----	---	---------------



MZ521N

Alarm contact (Mounted inside the motor starter)	1C	1A AC1 - 400V~ 2A AC1 - 230V~			1	MZ527N
--	----	----------------------------------	--	--	---	---------------

Under voltage release (To prevent automatic restarting of the controlled device)	230V~ 50Hz				1	MZ528N
	400V~ 50Hz				1	MZ529N

Surface mounting enclosure		Weatherproof IP55 Removable window			1	MZ521N
-----------------------------------	--	---------------------------------------	--	--	---	---------------

w. 78mm x h. 150mm x d. 95mm

Emergency stop button IP65		Mounted on surface mounting enclosure MZ521N			1	MZ530N
--------------------------------------	--	--	--	--	---	---------------

Earth Fault Relays

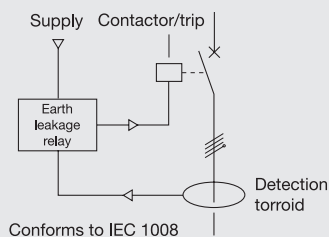

Earth fault relays with separate detection torroids

These units ensure the protection of electrical installations. 30mA versions can provide supplementary protection against direct connection.

This range of electronic earth fault relays provide monitoring of earth fault currents. When the fault current rises above the selected level, the output contacts of the product operate. Depending on the relay selected, it can have either fixed or adjustable sensitivity, a time delay is also available for selectivity purposes. The relays are linked with detection torroids, 14 separate types are available, circular and rectangular in section (see page 110).

Common characteristics

- Positive safety: the relay trips in the event of a break in the relay/torroid link.
- Positive reset required after a fault is detected.
- Test button for simulation of a fault.
- Protected against nuisance tripping from transients.
- DC sensitive.
- Output: 1 C/O contact 250V~ 6A AC1.
- Visual display of fault by red LED

Features according to the selected devices

- Adjustment of sensitivity and delay (sealable).
- Extra positive safety contact (1C/O 250V~ 6A AC1).
- Display of fault current before it triggers the relay (5% to 75%).

- Extra output contact (250V 0.1A max.) to enable remote indication of fault currents over 50% of $I_{\Delta n}$.
- Remote test and reset by 3 wire link.

Torroids

Circular dia. 35, 70, 105, 140, 210mm
 Rectangular 70 x 175, 115 x 305, 150 x 350mm
 Connection capacity
 Relay - 1.5 to 6mm²
 Relay - torroid link
 2 wires, 25m max.
 Test and remote reset link
 3 wires, 20m max.
 For enclosure selection, please consult us.



HR400



HR420

Designation	Characteristics	Width in ■ 17.5mm	Pack qty.	Cat Ref.
Earth fault relay C/O contact 6A~ AC1	Instant trip, fixed sensitivity $I_{\Delta n} = 30\text{mA}$	2	1	HR400
	300mA	2	1	HR402
Earth fault relay C/O contact 6A~ AC1 Adjustable sensitivity $I_{\Delta n} = 30, 100, 300\text{mA}$ 1 & 3A	Instant trip or time delay 0.13 - 0.3 - 1 & 3 sec	3	1	HR410
	Standard version	3	1	HR411
Earth fault relay C/O contact 6A~ AC1 Positive safety C/O contact 6A~ AC1 Adjustable sensitivity $I_{\Delta n} = 30, 100, 300\text{mA}$ 1 & 3A Instant or time delayed 0.13 - 0.3 - 1 & 3 sec	Version with LED optical scale	3	1	HR420
	Version with LED optical scale and remote test	5	1	HR425
	Earth leakage relay with integral torroid adjustable sensitivity as above instant or time delayed as above.	4	1	HR440
		6	1	HR441

Earth Fault Relay - Torroids



HR802



HR830



HR820

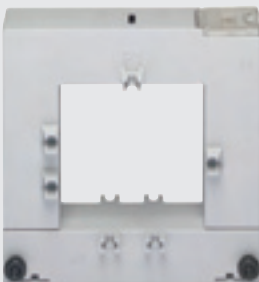

HR822

<i>Designation</i>	<i>Characteristics</i>	<i>Pack qty.</i>	<i>Cat Ref.</i>
Circular section torroid	ø 30mm	1	HR800
	ø 35mm	1	HR801
	ø 70mm	1	HR802
	ø 105mm	1	HR803
	ø 140mm	1	HR804
	ø 210 mm	1	HR805
Rectangular section torroid	70 x 175mm	1	HR830
	115 x 305mm	1	HR831
	150 x 350mm	1	HR832
Rectangular split torroid	20 x 30mm	1	HR820
	50 x 80mm	1	HR821
	80 x 80mm	1	HR822
	80 x 121mm	1	HR823
	80 x 161mm	1	HR824

Surge Protection Devices (SPD)

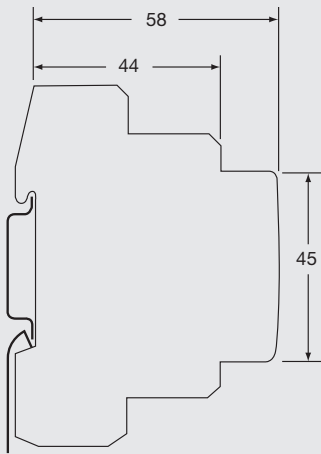

SPD's protect electric and electronic equipment against transients, originating from lightning, switching of transformers, lighting and motors

These transients can cause premature ageing of equipment, down time, or complete destruction of electronic components and material

SPDs are strongly recommended on installations that are exposed to transients, to protect sensitive and expensive electrical equipment such as TV, video, washing machines, Hi-fi, PC, alarm etc.

The choice of SPD depends on a number of criteria such as:

- The exposure of the building to transients.
- The sensitivity and value of the electrical equipment that requires protection.
- Earthing system
- Level of protection

The range of SPDs is separated into 2 types of protection:

1. Main protection - class 2 SPDs with higher discharge current ($I_{max} 8/20$), to evacuate as much of the transient to earth as possible
2. Fine protection - class 2 + 3 SPDs with low voltage protection level ($U_p \leq 1000V$), to cut-down the transient surge as low as possible to protect very sensitive equipment.

Technical data

Complies with IEC61643-1

Reserve status indicator (R versions)



End of life indicator (D versions)

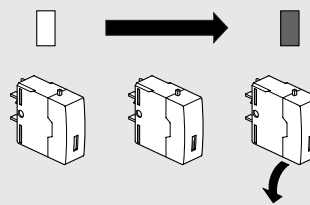

OK



auxiliary contact for remote signalling (R versions only)



230V~ 1A
12V ... 10mA

Installation and connection

The main protection SPDs are installed directly after the main incoming switch or RCCB (type S).

SPDs can be used in any supply system e.g TNCS, TNS, TT.

Options: Replacement cartridges.

Connected in parallel to the equipment to be protected.

Protection is assured in both common and differential modes.

For technical details see page 3.65 - 3.66



SPN215D

Designation	Characteristics	Width in 17.5mm	Pack qty.	Cat Ref.
Un: 230/400 V 50/60 Hz	Single pole Up: 1.2kV at In	1	1	SPN140D
Un: 230/400 V 50/60 Hz	2 poles, 1ø + N with reserve indicator and auxiliary contacts Up: 1.0kV at In	2	1	SPN215R
Un: 230/400 V 50/60 Hz	2 poles 1ø + N Up: 1.0kV at In	2	1	SPN215D
Un: 230/400 V 50/60 Hz	4 pole 3ø + N with reserve indicator and auxiliary contacts Up: 1.2kV at In	4	1	SPN415R
Un: 230/400 V 50/60 Hz	4 poles 3ø + N Up: 1.0kV at In	4	1	SPN415D

Surge Protection Devices (SPD)

SPDs with low let through voltage levels

To protect very sensitive electronic equipment. This fine protection complements the main protection and can protect 1 or many electronic devices.

Optimal coordination is obtained when cascaded with a main protection device (lower U_p - see the table below).

Discharge current: I_{max} . 8kA (8/20 wave) a green LED on the front face indicates the status of the SPD SPN208S, connected in series with the equipment that needs to be protected (with a maximum line current of 25A). Protection is assured in both common and differential modes

Connection capacity

- Terminal blocks L, N & E
- Rigid conductor: 10mm²
 - Flexible conductor: 6mm²

Replacement cartridges

These cartridges replace the cartridge in the main SPD (page 3.24).

They allow simple replacement without the need to cut-off the power supply.

Cartridges are available for all discharge currents (40kA and 15kA) with and without condition indication.

A keying system exists to prevent a line cartridge being interchanged by mistake with a neutral one and visa versa neutral cartridges have a

discharge current of 65kA

Replacement cartridges for phase:

- SPN140D = SPN040D
- SPN215D = SPN015D
- SPN415D = SPN015D
- SPN215R = SPN015R
- SPN415R = SPN015R

For neutral / earth

- SPN215D = SPN040N
- SPN415D = SPN040N
- SPN215R = SPN040N
- SPN415R = SPN040N

☐ For technical details see page 3.65 - 3.66

Designation	Characteristics	Width in 17.5mm	Pack qty.	Cat Ref.												
SPD With low voltage protection level (Class 2) Uc: 230/400V 50/60 Hz Up (L,N/E): 1.2kV at In Up (L/N): 1kV at In	rated at 25 A 2 pole 1ø + N cascading table (main protection + fine protection) voltage protection level: Up <table border="1"> <thead> <tr> <th>Ip</th> <th>Up L, N/E</th> <th>Up L/N</th> </tr> </thead> <tbody> <tr> <td>15kA</td> <td>900V</td> <td>800V</td> </tr> <tr> <td>40kA</td> <td>900V</td> <td>800V</td> </tr> <tr> <td>65kA</td> <td>850V</td> <td>750V</td> </tr> </tbody> </table>	Ip	Up L, N/E	Up L/N	15kA	900V	800V	40kA	900V	800V	65kA	850V	750V	1	1	SPN208S
Ip	Up L, N/E	Up L/N														
15kA	900V	800V														
40kA	900V	800V														
65kA	850V	750V														



SPN208S

125A Frame MCCBs

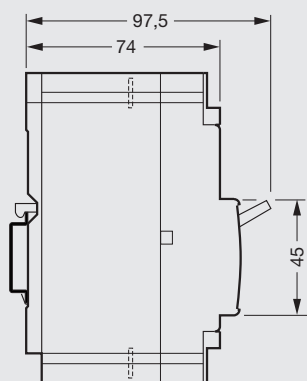

Description

The Hager range of MCCBs offer panelbuilders and OEM's, a wide choice of options. The 125A frame is available in 1,3 and 4 poles, with a breaking capacity of 16kA, or 25kA.

Technical data

Complies with - BS EN 60947-2
 Current rating - 16, 20, 25,32,40,50,63,80,100 and 125A
 Voltage - 1P-230VAC 3 & 4P 230/400VAC
 Short circuit capacity - $I_{cs} = 100\%$

Thermal adjustment: 4P and 3P 0.8-1, SP fixed.
 Magnetic adjustment: fixed
 Cable capacity - 70mm², max
 Bar width = 12mm²

For technical details see page 3.40 - 3.44



HD105



HD149U

Designation	Current rating (A)	Poles	Icu kA	Ics % Icu	Pack qty	Cat Ref. 16KA	Cat Ref. 25KA
MCCB	16	1	16	100	1	HD101	HH101
MCCB	20	1	16	100	1	HD102	HH102
MCCB	25	1	16	100	1	HD103	HH103
MCCB	32	1	16	100	1	HD104	HH104
MCCB	40	1	16	100	1	HD105	HH105
MCCB	50	1	16	100	1	HD106	HH106
MCCB	63	1	16	100	1	HD107	HH107
MCCB	80	1	16	100	1	HD108	HH108
MCCB	100	1	16	100	1	HD109	HH109
MCCB	125	1	16	100	1	HD110	HH110
<hr/>							
MCCB	20-25	3	16	100	1	HD143U	HH143U
MCCB	32-40	3	16	100	1	HD145U	HH145U
MCCB	50-63	3	16	100	1	HD147U	HH147U
MCCB	63-80	3	16	100	1	HD148U	HH148U
MCCB	80-100	3	16	100	1	HD149U	HH149U
MCCB	100-125	3	16	100	1	HD150U	HH150U
<hr/>							
MCCB	50-63	4	16	100	1	HD167U	
MCCB	80-100	4	16	100	1	HD169U	
MCCB	100-125	4	16	100	1	HD170U	
<hr/>							
Non automatic	125	3			1	HC101	
Non automatic	125	4			1	HC102	

125A frame MCCBs - Accessories and Auxiliaries

Earth fault blocks (4P only)

Mounting - right side
Rated current - 125A (40 °C)

Internal auxiliaries

Shunt trip - for remote tripping of the MCCB, operates when coil is energised.
Under voltage release - for remote tripping of the MCCB, operates when the coil is de-energised.

Auxiliary contact - allows remote indication of the MCCB contacts.

Alarm contact - remotely indicates the tripped status of the MCCB

Designation

Pack
qty

Cat Ref.

Add-on earth fault block

Sensitivity - adjustable
0.03, 0.1, 0.3, 1, 3, 10A

Time delay settings
instantaneous
0.06, 0.15, 0.3, 0.5, 1s

1

HB112



HB112

Designation

Coil rating
(V)

Power
consumption (VA)

Operating
voltage (Un)

Pack
qty

Cat Ref.

Shunt trip

12-60V ac/dc

110-240V ac/dc

380-415V ac

300

300

>75%

>75%

1

1

HX101E

HX104E

HX105E

Under voltage release

208-240V ac

380-500V ac

≤70%

≤70%

1

1

HX114E

HX115E

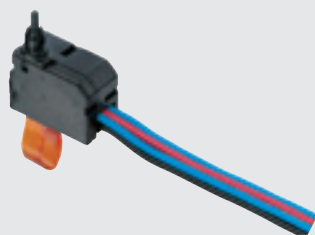

HX122

Designation

Contact
rat. 400VAC

Contact
rat. 230VAC

Contact
rat. 110VAC

Pack
qty

Cat Ref.

Auxiliary contacts

Auxiliary 2 N/O

Auxiliary and alarm C/O

1.5A

1.5A

3A

3A

4A

4A

1

1

HX122

HX123



HX131

Designation

Type

Shaft
length mm

Padlockable
off

Pack
qty

Cat Ref.

Rotary handles

Direct

Indirect

-

200mm

Yes

Yes

1

1

HX130

HX131A



HY122

Accessories

Terminal shield 3P

Terminal shield 4P

Padlock kit for 125A MCCB

2

2

1

HY121

HY122

HX139

250A Frame MCCBs

Description

The Hager range of MCCBs offer panelbuilders and OEM's, a wide choice of options. The 250A frame is available with a breaking capacity up to 40kA

Technical data

Standards - BS EN 60947-2
 Current rating - 160, 250A
 Voltage - 230/400VAC
 Short circuit capacity - 3 & 4P Icu = Ics = 40KA

Thermal adjustment

3 & 4P - 0.8 -1 x In
 magnetic adjustment - 3 & 4P 5 - 10 x In
 Cable capacity - 120mm², max bar width = 20mm²

For technical details see page 3.40 - 3.44



HH253

<i>Designation</i>	<i>Current rating (A)</i>	<i>Poles</i>	<i>Icu kA</i>	<i>Ics %Icu</i>	<i>Pack qty</i>	<i>Cat Ref.</i>
MCCB	80	3	40	100	1	HN251
MCCB	100	3	40	100	1	HN252
MCCB	125	3	40	100	1	HN253
MCCB	160	3	40	100	1	HN254
MCCB	200	3	40	100	1	HN203
MCCB	250	3	40	100	1	HN204
MCCB	160	4	40	100	1	HN264
MCCB	200	4	40	100	1	HN213
MCCB	250	4	40	100	1	HN214
Non automatic	250	3			1	HC203
Non automatic	250	4			1	HC204

250A Frame MCCBs - Accessories and Auxiliaries

Earth fault blocks (4P only)

Mounting - underneath
rated current - 250A.

Internal Auxiliaries

Shunt trip - for remote tripping of
the MCCB, operates when coil is
energised.

Under voltage release - for
remote tripping of the MCCB,
operates when the coil is
de-energised

Auxiliary contact - allows remote
indication of the MCCB contacts
Alarm contact - remotely
indicates the tripped status of
the MCCB.

Designation	Pack qty	Cat Ref.
-------------	----------	----------

Add-on Earth Fault Block

Sensitivity - adjustable
0.03, 0.1, 0.3, 1, 3, 10A

Time delay settings
instantaneous
0.06, 0.15, 0.3, 0.5, 1s

1 **HB211**



HX104E

Designation	Coil rating (V)	Power consumption (VA)	Operating voltage (Un)	Pack qty	Cat Ref.
-------------	-----------------	------------------------	------------------------	----------	----------

Shunt trip

12-60V AC/DC	300	>75%	1	HX101E
110-240V AC/DC	300	>75%	1	HX104E
380-415V AC	300	>75%	1	HX105E

Under voltage release

230	5	≤70%	1	HX114E
400	5	≤70%	1	HX115E

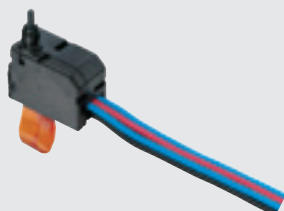

HX122

Designation	Contact rat. 400VAC	Contact rat. 230VAC	Contact 110VAC	Pack qty	Cat Ref.
-------------	---------------------	---------------------	----------------	----------	----------

Auxiliary contacts

Auxiliary 2 N/O	1.5A	3A	4A	1	HX122
Auxiliary and alarm C/O	1.5A	3A	4A	1	HX223E



HX230

Designation	Type	Shaft length mm	Padlockable off	Pack qty	Cat Ref.
-------------	------	-----------------	-----------------	----------	----------

Rotary handles

direct	-	yes	1	HX230
indirect	200mm	yes	1	HX231



HX239

Accessories

Terminal shield 3P	2	HY221
Terminal shield 4P	2	HY222
Padlock attachment - for standard toggle	1	HX239

400A Frame MCCBs

Description

The Hager range of MCCBs offer panelbuilders and OEM's, a wide choice of options. The 400A frame is available with a range of auxiliaries or accessories.

Technical data

Complies with - BS EN 60947-2
Current rating - 250-400
Voltage - 230/400VAC
Short circuit capacity -
Icu = Ics = 45KA

Thermal adjustment

3 & 4P - 0.8 - 1x In
magnetic adjustment - 3 & 4P
5 - 10 x In
cable capacity - 240mm², max
bar width = 32mm²

☐ For technical details
see page 3.40 - 3.44



HN303E

Designation	Current rating (A)	Poles	Icu kA	Ics % Icu	Pack qty	Cat Ref.
MCCB	250	3	50	100	1	HN301E
MCCB	320	3	50	100	1	HN302E
MCCB	400	3	50	100	1	HN303E
MCCB	250	4	50	100	1	HN321E
MCCB	320	4	50	100	1	HN322E
MCCB	400	4	50	100	1	HN323E
non auto	400	3			1	HC301E
non auto	400	4			1	HC302E

400A frame MCCBs - Accessories and Auxiliaries



HX104E

Designation	Coil rating (V)	Power consumption (VA)	Operating voltage (Un)	Pack qty	Cat Ref.
Shunt trip					
	12-60V AC/DC	300	>75%	1	HX101E
	110-240V AC/DC	300	>75%	1	HX104E
	380-415 AC	300	>75%	1	HX105E
Under voltage release					
	208-240V	5	≤70%	1	HX114E
	380-500V	5	≤70%	1	HX115E

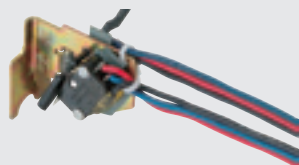

HX722

Designation	Contact rat. 400VAC	Contact rat. 230VAC	Contact 110VAC	Pack qty	Cat Ref.
Auxiliary contacts					
Auxiliary 2 N/O	1.5A	6A	4A	1	HX122
Auxiliary and alarm C/O	1.5A	3A	4A	1	HX223E

Designation	Type	Shaft length mm	Padlockable off	Pack qty	Cat Ref.
Rotary handles					
	Direct	-	yes	1	HX330E
	Indirect	200mm	yes	1	HX331E

Accessories					
3 pole shroud				2	HY321E
4 pole shroud				2	HY322E
Toggle locking kit				1	HX339E

630A Frame MCCBs

Description

The Hager range of MCCBs offer panelbuilders and OEM's, a wide choice of options. The 630A frame is available with a range of auxiliaries or accessories

Technical data

Standards - BS EN 60947-2 and IEC947-2
 Current rating - 500-800
 Voltage - 3 & 4P 400/415VAC
 Short circuit capacity - 3 & 4P Icu = Ics = 50KA

Thermal adjustment

3 & 4P - 0.8 - 1 x In
 magnetic adjustment - 3 & 4P
 5 - 10 x In
 cable capacity - 2 x 240mm²,
 max bar width = 50mm²

☐ For technical details see page 3.40 - 3.44



HN802

Designation	Current rating (A)	Poles	Icu kA	Ics % Icu	Pack qty	Cat Ref.
MCCB	500	3	50	100	1	HN802
MCCB	630	3	50	100	1	HN803
MCCB	800	3	50	100	1	HN806
MCCB	500	4	50	100	1	HN812
MCCB	630	4	50	100	1	HN813
MCCB	800	4	50	100	1	HN816
non auto	630	3			1	HC801
non auto	630	4			1	HC802
non auto	800	3			1	HC803
non auto	800	4			1	HC804

630A frame MCCBs - Accessories and Auxiliaries



HX830

Designation	Coil rating (V AC)	Power consumption (VA)	Operating voltage (Un)	Pack qty	Cat Ref.
Shunt trip					
	12-60V AC/DC	300	>75%	1	HX801
	110-240VAC/DC	300	>75%	1	HX804
	400V AC		>75%	1	HX805
Under voltage release					
	230	5	≤70%	1	HX814
	400	5	≤70%	1	HX815



HX831

Designation	Contact rat. 400VAC	Contact rat. 230VAC	Contact 110VAC	Pack qty	Cat Ref.
Auxiliary contacts					
Auxiliary 2 N/O	1.5A	3A	4A	1	HX822
Auxiliary and alarm C/O*	1.5A	3A	4A	1	HX823
Designation	Type	Shaft length mm	Padlockable off	Pack qty	Cat Ref.
Rotary handles					
	Direct	-	Yes	1	HX830
	Indirect	200mm	Yes	1	HX831

Basic Principles

The proper selection of the correct circuit protective device requires an understanding of the potential hazards against which protection for safety is required. The Wiring Regulations identify several hazards:

- Electric shock
- Thermal effects
- Overcurrent
- Undervoltage
- Isolation

Electric shock - is divided into two parts:

- Direct contact: contact with parts which result in an electric shock in normal service
- Indirect contact: contact with exposed conductive parts which result in an electric shock in case of a fault.

To protect against direct contact the Wiring Regulations suggest the following basic measures should be taken:

- (1) by insulation of live parts
- (2) by enclosures or barriers
- (3) by obstacles
- (4) by placing out of reach

To protect against indirect contact the Wiring Regulations suggest the following basic measures should be taken:

- (1) Earthed equipotential bonding and automatic disconnection of supply
- (2) Use of class II equipment or equivalent insulation
- (3) Non-conducting location
- (4) Earth-free local equipotential bonding
- (5) Electrical separation

Of these five measures, the first is by far the most commonly used -

- (1) Earthed equipotential bonding and automatic disconnection of supply:

In each installation circuit protective conductors connect all exposed conductive parts of the installation to the main earthing terminal. Main equipotential bonding conductors are used to connect extraneous conductive parts of other incoming services and structural metalwork to the main earthing terminal. These extraneous conductive parts include the following:

- Main water pipes
- Gas installation pipes
- Other service pipes and ducting
- Risers of central heating and air conditioning systems
- Exposed metal parts of the building structure

This bonding creates a zone within which any voltages appearing between exposed conductive parts and extraneous conductive parts, are minimised; the earth fault loop impedance must have a value low enough to allow sufficient current to flow for the circuit protective device to operate rapidly to disconnect the supply; disconnection must be sufficiently fast so that voltages appearing on the bonded metalwork cannot persist long enough to cause danger; depending on the operating characteristics of the protective device and the earth impedance, such disconnection may be achieved either by overcurrent devices, Fuses, Miniature Circuit Breakers, (i.e. MCBs) or by Residual Current Devices, (i.e. RCCBs).

Thermal Effect - refers to heat generated by the electrical equipment in normal use and under fault conditions. The proper selection of equipment complying with the latest product standards is essential in providing protection against thermal effects.

Overcurrent - is defined as a current exceeding the rated value of the circuit components. It may be caused by the overloading of a healthy circuit or it may take the form of a short-circuit current, defined as an "overcurrent resulting from a fault of negligible impedance between live conductors having a difference in potential under normal operating conditions". Overcurrent protection may be provided by using fuses or circuit breakers singly or in combination.

Undervoltage - refers to the dangers that could be caused by the reduction or loss in voltage and the subsequent restoration, such as the unexpected re-starting of motors or the automatic closing of protective devices. The proper selection of control and protective devices must take the protection against undervoltage into consideration.

Isolation - every circuit shall be provided with means of isolation (except in certain cases) to prevent or remove hazards associated with the installation, equipment and machines. The new standards for circuit breakers and switch-fuses now take this into account.

Protection against shock by indirect contact

Indirect contact - is the contact of persons or livestock with exposed conductive parts made live by a fault and which may result in electric shock. An example would be where the insulation of an electric heater has broken down resulting in a live conductor internally touching the casing. This could result in the heater casing being raised to a hazardous voltage level, causing electric shock to a person touching it.

Two important measures must be taken to prevent this hazard:

- The impedance of circuit conductors is kept to a minimum. The earth fault loop impedance (Z_s) is used as a measure of the circuit impedance under fault conditions.
- The overcurrent device protecting the circuit is selected to rapidly disconnect an earth fault.

The effect of these two measures is inter-related.

1. By ensuring that the circuit protective conductor is of a low impedance, the voltage to which the live casing is raised, under fault conditions, is kept to a minimum.
2. The low impedance path provided by the circuit conductors and the circuit protective conductor will result in a high level of current in the event of an earth fault. This high fault current ensures that the overcurrent protective device will disconnect the fault in a short time, reducing the interval during which the casing of the faulty equipment is live.

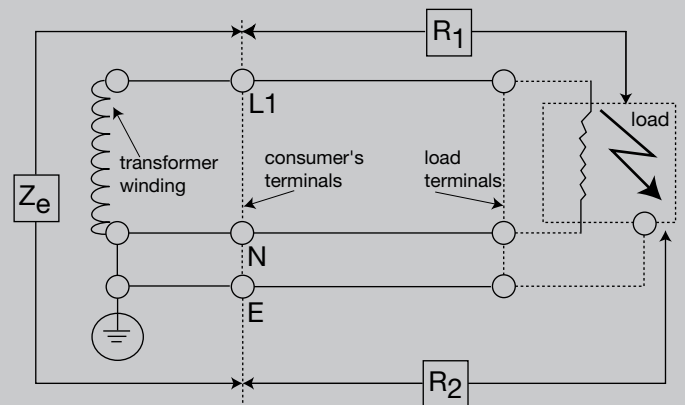

Fig 2

Components of earth fault loop impedance (Z_s) in a system. (Earth fault at load between conductor and casing).

$$Z_s = Z_e + (R_1 + R_2)$$

Earth fault loop impedance (Z_s)

To ensure the impedance of conductors in a circuit is sufficiently low the system designer has to establish the value of the earth fault loop impedance.

Z_s is a measure of the earth fault current loop, comprising the phase conductor and the protective conductor. It comprises the complete loop including the winding of the transformer from which the circuit is supplied as defined by the following:

Z_e is the part of the earth fault loop impedance external to the installation, its value can be measured or a nominal value can be obtained from the supply authority.

$(R_1 + R_2)$ - Where R_1 is the resistance of the phase conductor within the installation and R_2 is the resistance of the circuit protective conductor. These two components constitute the loop impedance within the installation.

Therefore: $Z_s = Z_e + (R_1 + R_2)$

Once the value of Z_s has been established a suitable overcurrent protective device has to be selected to ensure disconnection of an earth fault within the specified time. The times are:

- 5 seconds for fixed equipment.
- For portable equipment and for fixed equipment installed outside the equipotential bonding zone, the disconnection times are dependent on the nominal voltage to earth, i.e. 220 to 277 volts = 0.4 seconds.

Z_s by Calculation

To establish whether the relevant disconnection time can be achieved a simple calculation must be made, based on Ohm's law:

$$I_f \text{ (fault current)} = \frac{U_{oc} \text{ (open circuit voltage)*}}{Z_s \text{ (earth fault loop)}}$$

* voltage between phase and earth (240V)

The fault current (I_f) must be high enough to cause the circuit protective device to trip in the specified time. This can be established by consulting the time/current characteristic for the protective device. If the maximum trip time for the fault current calculated is less than or equal to the relevant value (5s for fixed equipment; 0.4s for portable equipment) then compliance is achieved. It is important that when consulting the characteristic curve the worst case is used, i.e. the maximum tripping time including any tolerance. An example is shown in Figs 1 and 2.

Z_s by tables

The above procedure can be used for any type of protective device providing a time/current characteristic curve is available. Frequently, however, a much simpler method is available using tables listing maximum Z_s values which have been interpreted from the characteristic curves for the relevant devices. Providing the system Z_s is equal to or less than the value given in the table, compliance is achieved. Tables for a number of 'standard' devices (certain fuses and MCBs) are given in the Wiring Regulations.

Z_s too high

If the system Z_s value is too high to achieve rapid enough disconnection with the overcurrent protective devices available then it is necessary to use one of the two following methods:

- Fit a cable with a larger cross-section and consequently a lower impedance. This may be a very expensive solution especially when the installation is complete before the problem is discovered.
- Use a Hager residual current device (RCCB). Subject to certain conditions being met this provides a simple and economical solution.

Example

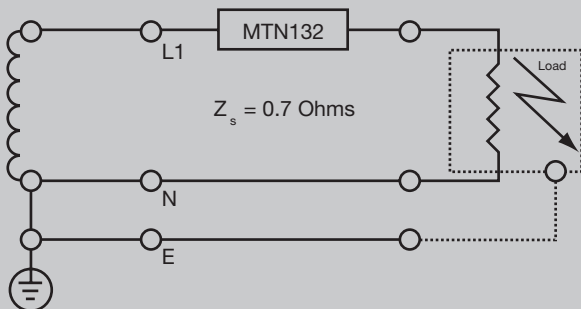

Fig 2

Fig 2 shows a fixed circuit with an earth loop impedance Z_s of 0.7 ohms protected with an MTN132. The fault current (I_f) will therefore be $U_o/Z_s = 240/0.7 = 343A$

By referring to the characteristic for MTN132 (see Fig 3) it can be seen that the breaker will disconnect in 0.02 seconds for this current. The breaker therefore easily satisfies the requirement for disconnection in 5 seconds.

If the circuit Z_s was 2.0 ohms then the fault current would be: $240/2 = 120A$ and the disconnection time would be 10 seconds, in which case compliance would not be achieved.

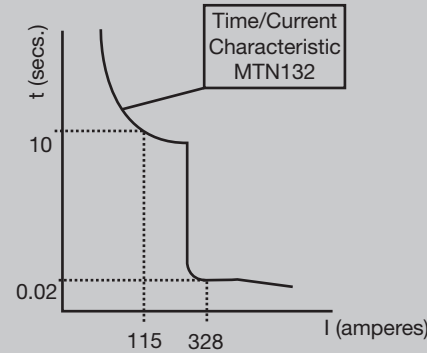

Fig 3

Protection against overcurrent

Overcurrent - "A current exceeding the rated value. For conductors the rated value is the current-carrying capacity"

Overload Current - "An overcurrent occurring in a circuit which is electrically sound"

Short-Circuit Current - "An overcurrent resulting from a fault of negligible impedance between live conductors having a difference in potential under normal operating conditions."

Protection against Overload Current

For the protection against overload current, protective devices must be provided in the circuit to break any overload current flowing in the circuit conductors before it can cause a temperature rise which would be detrimental to insulation, joints, terminations or the surroundings of the conductors.

In order to achieve this protection the nominal current of the protective device I_n should be not less than the design current of the circuit I_b and that I_n should not exceed the current-carrying capacity of the conductors I_z , and that the current causing effective operation of the protective device I_2 does not exceed 1.45 times the current-carrying capacity of the conductor I_z , expressed as

$$I_b \leq I_n \leq I_z$$

$$I_2 \leq 1.45 I_z$$

Protection against Short-Circuit Current

Protective devices must be provided to break any short-circuit current before it can cause danger due to thermal and mechanical (electro-dynamic) effects produced in the conductors and connections. The breaking capacity of the protective device shall not be less than the prospective short-circuit current at the point at which the device is installed. However a lower breaking capacity is permitted provided that a properly co-ordinated back-up device having the necessary breaking capacity is installed on the supply side (see page 3.43).

Positioning of Overcurrent Devices

Devices for the protection against overload and short-circuit must be placed at the point where a reduction occurs in the current-carrying capacity of the conductors. This reduction could be caused by a change in the environmental conditions as well as the more obvious change in the cross-sectional area of the cable.

There are of course exceptions to this general rule which relate to a very few special applications. These are set out in detail in the Wiring Regulations.

Both of the new British Standards covering Low Voltage Circuit Breakers provide the user with a better assurance of quality and performance by taking into account the actual operating conditions of the breaker. New definitions and symbols have been introduced which should be committed to memory. Some of those most frequently used are:

- U_e : Rated service voltage
- U_i : Rated insulation voltage (> U_{emax})
- U_{imp} : Rated impulse withstand
- I_{cm} : Rated short circuit making capacity
- I_{cn} : Rated short circuit capacity
- I_{cs} : Rated service short circuit breaking capacity
- I_{cu} : Rated ultimate short circuit breaking capacity
- $I_{\Delta n}$: Rated residual operating current (often called residual sensitivity)
- I_n : Rated current = maximum value of current used for the temperature rise test
- Δ_t : trip delay of residual current devices

In addition BS EN 60898 sets out to provide a greater degree of safety to the uninstructed users of circuit breakers. It is interesting to note that the description "miniature circuit breaker" or MCB is not used at all in this standard, but no doubt both manufacturers and users will continue to call circuit breakers complying with BS EN 60898 miniature circuit breakers or MCBs for some time to come.

The scope of this standard is limited to ac air break circuit breakers for operation at 50Hz or 60Hz, having a rated current not exceeding 125A and a rated short-circuit capacity not exceeding 25kA.

A rated service short-circuit breaking capacity I_{cs} is also included which is equal to the rated short-circuit capacity I_{cn} for short-circuit capacity values up to and including 6kA, and 50% of I_{cn} above 6kA with a minimum value of 7.5kA. As the circuit-breakers covered by this standard are intended for household and similar uses, I_{cs} is of academic interest only. The rated short-circuit capacity of a MCB (I_{cn}) is the alternating component of the prospective current expressed by its r.m.s. value, which the MCB is designed to make, carry for its opening time and to break under specified conditions. I_{cn} is shown on the MCB label in a rectangular box without the suffix 'A' and is the value which is used for application purposes. I_{cn} (of the MCB) should be equal to or greater than the prospective short-circuit current at the point of application.

You will see from the curves that the inverse time / current characteristic which provides overload protection is the same on all three. This is because the British Standard requires the breaker to carry 1.13 times the rated current without tripping for at least one hour and when the test current is increased to 1.45 times the rated current, it must trip within one hour, and again from cold if the current is increased to 2.55 times the rated current the breaker must trip between 1 and 120 seconds. The inverse time delay characteristic of all MCBs claiming compliance with BS EN 60898 must operate within these limits.

The difference between the three types of characteristic curves designated 'B', 'C' and 'D' concerns only the magnetic instantaneous trip which provides short-circuit protection.

- For type 'B' the breaker must trip between the limits of 3 to 5 times rated current
- For type 'C' the breaker must trip between the limits of 5 to 10 times rated current, and
- For type 'D' the breaker must trip between the limits of 10 to 20 times rated current.

Often manufacturers publish their MCB tripping characteristics showing the limits set by the standard and guarantee that any breaker that you purchase will operate within these limits. So great care should be taken when working with characteristic curves showing lower and higher limits - on no account should you take a mean point for application design purposes.

For cable protection applications you should take the maximum tripping time and some manufacturers publish single line characteristic curves which show the maximum tripping time. If the design problem is nuisance tripping then the minimum tripping time should be used and for desk top co-ordination studies, both lower and upper limits have to be taken into account.

Energy limiting

Energy is measured in Joules. *James Prescott Joule proved that thermal energy was produced when an electric current flowed through a resistance for a certain time, giving us the formula :-

$$\text{Joules} = I^2 \times R \times t \text{ or because we know that watts} = I^2 R$$

$$\text{Joules} = \text{watts} \times \text{seconds}$$

Therefore we can say that :-

$$\text{One Joule} = \text{one watt second}$$

$$\text{or energy} = \text{watts} \times \text{seconds} = I^2 R t$$

If the resistance (R) remains constant or is very small compared with the current (I) as in the case of short-circuit current, then energy becomes proportional to $I^2 t$. Which is why the energy let-through of a protective device is expressed in ampere squared seconds and referred to as $I^2 t$

$I^2 t$ (Joule Integral) is the integral of the square of the current over a given time interval (t_0, t_1)

The $I^2 t$ characteristic of a circuit breaker is shown as a curve giving the maximum values of $I^2 t$ as a function of the prospective current.

Manufacturers are required by the British Standard to produce the $I^2 t$ characteristic of their circuit breakers.

See page 3.39.

The energy limiting characteristics of modern MCBs greatly reduce the damage that might otherwise be caused by short-circuits. They protect the cable insulation and reduce the risk of fire and other damage. Knowledge of the energy limiting characteristic of a circuit breaker also helps the circuit designer calculate discrimination with other protective devices in the same circuit.

Because of the importance of the energy limiting characteristic the British Standard for circuit breakers for household and similar installations suggests three energy limiting classes based on the permissible $I^2 t$ (let-through) values for circuit breakers up to 32A; class 3 having the best energy limiting performance.

All Hager MCBs exceed the requirements for energy let-through set by the British Standard for energy limiting class 3.

Electrical characteristics	References							
	MLN	MTN	NBN	NCN	NDN	HMF*	HMC	HMD
Poles	SP+N	SP	SP DP TP 4P	SP DP TP 4P	SP DP TP 4P	SP DP TP 4P		
Rated operational voltage U_e (V)	230	230	230/400	230/400	230/400	400		
Nominal current	6-40A	6-63A	6-63A	0.5-63A	6-63A	80-125A		
Breaking capacity to BS EN 60 898	6kA	6KA	10kA	10kA	10kA			
Breaking capacity to BS EN 60947-2	N/A	N/A	15kA	15kA	15kA	10kA	15kA	
Rated insulation voltage U_i (V)	500V	500V	500V	500V	500V	500V		
Rated impulse voltage U_{imp} (kV)	2500V	2500V	2500V	2500V	2500V	2500V		
Electrical endurance								
0.5 to 32A	10,000 cycles	20,000 cycles	10,000 cycles	10,000 cycles				
40 to 63A								

Table 11

* Din rail mount only, not for use in fixed busbar distribution boards.

Power loss

The power loss of MCB's is closely controlled by the standards and is calculated on the basis of the voltage drop across the main terminals measured at rated current. The power loss of Hager circuit breakers is very much lower than that required by the British Standard, so in consequences run cooler and are less affected when mounted together.

The table below gives the watts loss per pole at rated current.

MCB rated current (A)	0.5	1	2	3	4	6	10	16	20	25	32	40	50	63	80	100
Watts loss per pole (W)	1.3	1.5	1.7	2.1	2.4	2.7	1.8	2.6	2.8	3.3	3.9	4.3	4.8	5.2	8	10

Table 12

For use with DC

Because of their quick make and break design and excellent arc quenching capabilities Hager circuit breakers are suitable for DC applications.

The following parameters must be considered.

1 System voltage:
Determined by the number of poles connected in series (See table 13)

2 Short circuit current:
(See table 14)

3 Tripping characteristics:

- The thermal trip remains unchanged
- The magnetic trip will become less sensitive requiring derating by $\sqrt{2}$ the ac value. (See table 14)

No. of poles	1 pole		2 poles in series	
	max voltage	breaking capacity L/R=15ms	max voltage	breaking capacity L/R=15ms
MTN	60V	6kA	125V	6kA
NBN NCN NDN	60V	10kA	125V	10kA

Table 13

Characteristic curve	B		C		D	
	50Hz	dc	50Hz	dc	50Hz	dc
Magnetic trip						
I _{rm1}	3In	4.5 In	5In	7.5 In	10In	15In
I _{rm2}	5In	7.5 In	10In	15In	20In	30In

Table 14

Note: The circuit breaker can have the line\load connected to either the top or bottom terminals

Temperature Derating

MCBs are designed and calibrated to carry their rated current and to operate within their designated thermal time/current zone at 30°C. Testing is carried out with the breaker mounted singly in a vertical plane in a controlled environment. Therefore if the circuit breaker is required to operate in conditions which differ from the reference conditions, certain factors have to be applied to the standard data. For instance if the circuit breaker is required to operate in a higher ambient temperature than 30°C it will require progressively less current to trip within the designated time/current zone.

Correction Factor

The breaker is calibrated at a temperature of 30°C.

Temperature Correction

In (A)	30°C	35°C	40°C	45°C	50°C	55°C	60°C
0.5	0.5	0.47	0.45	0.4	0.38	-	-
1	1	0.95	0.9	0.8	0.7	0.6	0.5
2	2	1.9	1.7	1.6	1.5	1.4	1.3
3	3	2.8	2.5	2.4	2.3	2.1	1.9
4	4	3.7	3.5	3.3	3	2.8	2.5
6	6	5.6	5.3	5	4.6	4.2	3.8
10	10	9.4	8.8	8	7.5	7	6.4
16	16	15	14	13	12	11	10
20	20	18.5	17.5	16.5	15	14	13
25	25	23.5	22	20.5	19	17.5	16
32	32	30	28	26	24	22	20
40	40	37.5	35	33	30	28	25
50	50	47	44	41	38	35	32
63	63	59	55	51	48	44	40
80	80	76	72	68	64	60	56
100	100	95	90	85	80	75	70

Table 15

Grouping factors

Consideration should also be given to the proximity heating effect of the breakers themselves when fully loaded and mounted together in groups. There is a certain amount of watts loss from each breaker depending on the trip rating which may well elevate the ambient air temperature of the breaker above the ambient air temperature of the enclosure.

Grouping factor (rated current reduce by factor K)

no. of units n	K
n = 1	1
2 ≤ n < 4	0.95
4 ≤ n < 6	0.9
6 ≤ n	0.85

Table 16

Example

Five circuit breakers are to be installed inside an enclosure in a switchroom which has an average ambient air temperature of 35°C. Each circuit breaker will be required to supply a continuous current of 20A.

From Table 15 we would select a circuit breaker which has a rated current of 25A at 30°C and 23.5A at 35°C. This takes care of the switchroom ambient air temperature of 35°C, but we also have to take into account the grouping factor of five continuously loaded breakers mounted together in one enclosure. Table 16 gives us a grouping factor K of 0.9. We then apply this grouping factor to the rated current at 35°C which gives us a circuit breaker rated current of 23.5 x 0.9 = 21.15A in the specified conditions.

Frequency

Thermal – unchanged

Magnetic – value multiplied by coefficient K

F (Hz)	17Hz – 60Hz	100Hz	200Hz	400Hz
K	1	1.1	1.2	1.5

Table 17

'B' curve (BS EN 60 – 898)

MCBs: MTN rated 6 – 63A
NBN rated 6 – 63A

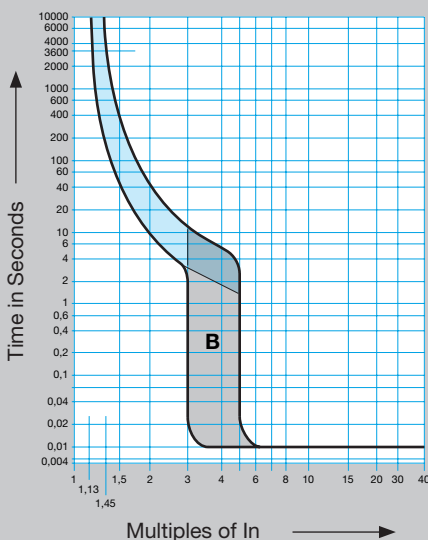

'C' curve (BS EN 60 – 898)

MCBs: NCN rated 0.5 – 63A
MLN rated 2 – 32A
NMF rated 80 – 100A

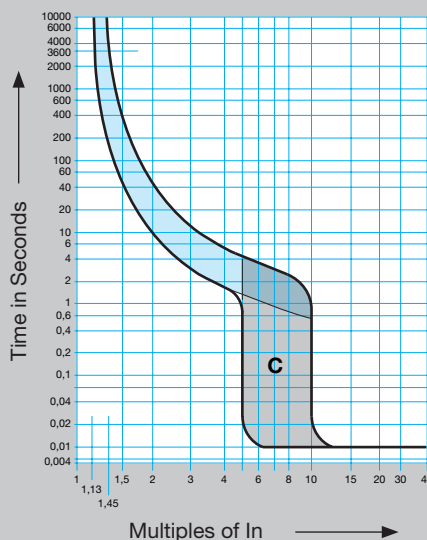

'D' curve (BS EN 60 – 898)

MCBs: NDN rated 6 – 63A
HMD rated 80-125A

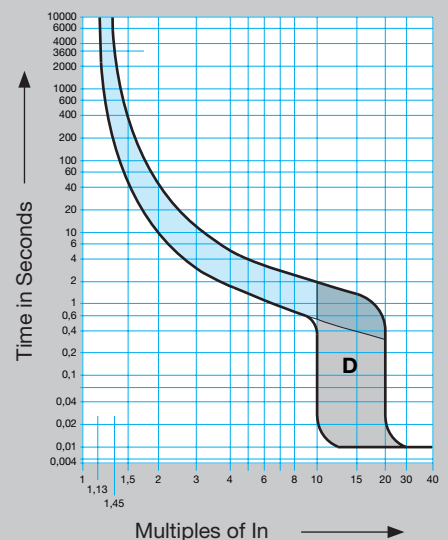

Fig 6

Current limiting at 400V
MTN NBN NCN NDN

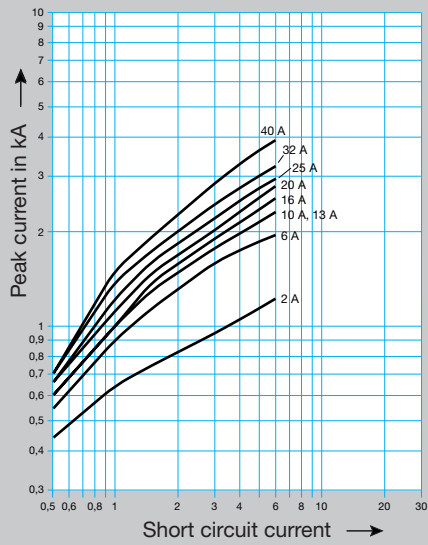
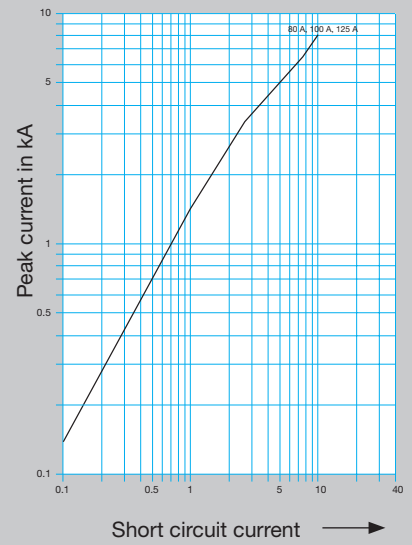
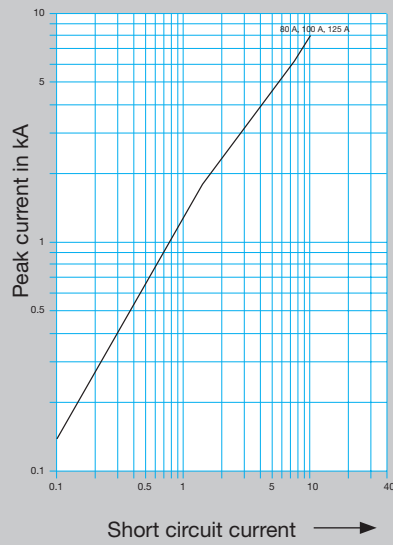

Fig 7

HMF, HMC, HMD 80 - 125A



Protection
Devices

Functions

Tripping and indication auxiliary contacts are common to the range of multi-pole 10kA MCBs, and RCCBs. They should be mounted on the left hand side of the device.

Auxiliary contact MZ201 (fig 9)

Allows remote indication of the status of the device contacts to which it is associated.

Auxiliary contact and alarm contact MZ202

This accessory has two separate functions. Like the MZ201 auxiliary contact, however the alarm contact will provide indication if the breaker trips under fault conditions.

MZ203 shunt trip*

Allows tripping of the device by feeding the coil. The contacts also allow for remote indication of operation.

MZ206 under voltage release* (fig 10)

Allows the MCB to trip when the voltage drops or by pressing a remote off switch (ie emergency stop).

* Indication that the product has tripped due to the voltage release is provided by a flag on the product.

Wiring diagram

MZ201 auxiliary contact and alarm contact

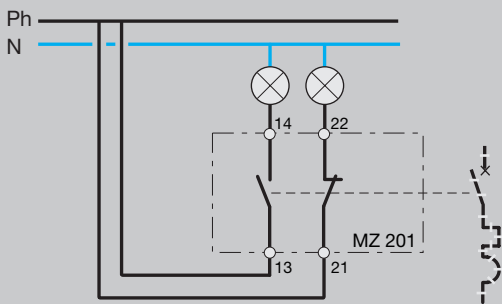

Fig 9

MZ206 under voltage release

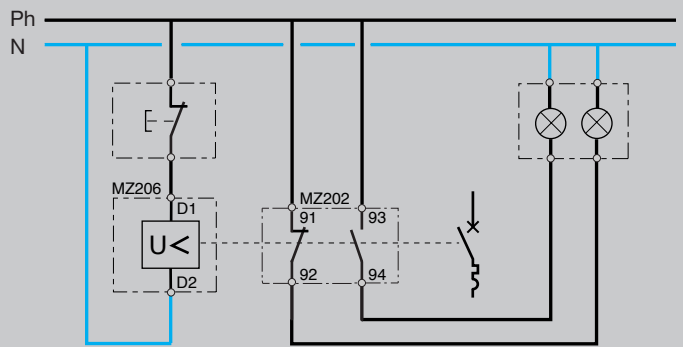

Fig 10

Electrical characteristics

	MZ201/MZ202	MZ203	MZ206
	1 x O 1 x C contact 230V~6A AC-1		
		230 - 415~ 110 - 130 ...	230V~ 50Hz

Table 18

Electrical connection

By terminal fitted with fixed clamp screws wiring capacity.
Flexible : 2 x 1.5mm²
Rigid : 2 x 1.5mm²

MZ203

Power - 8VA
tolerance : -15% of Un

MZ206

Latching voltage is between 35 and 70% of Un 230V~.
Coil consumption 3VA

Grouping / Combination of Several Auxiliaries

On 2, 3 and 4 pole MCBs it is possible to associate 3 auxiliaries – 2 indication auxiliaries and 1 release auxiliary. In this case, it is important to first fix the indication auxiliary (MZ201 and MZ202) and then the release auxiliary (MZ203 and MZ206)

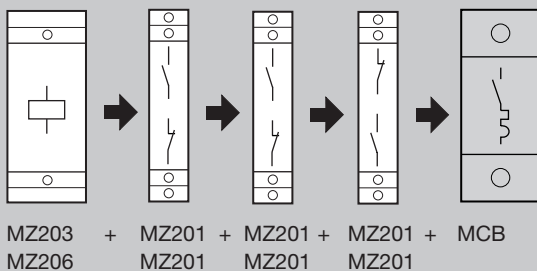

Fig 11

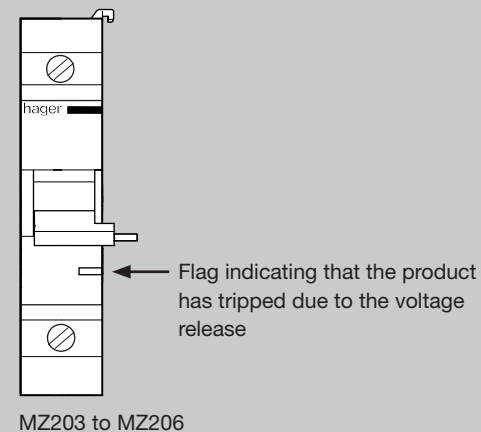

Fig 12

Transformer Protection

When a transformer is switched on, a high inrush current occurs in the primary circuit of the transformer irrespective of the load on the secondary side. Correct selection of the primary circuit protective device will avoid the risk of nuisance tripping due to this inrush current. Tables 19 & 20 show the recommended MCB's for the protection of single phase (230V) and three phase (400V) transformers.

Single Phase 230V

Transformer Rating (VA)	Primary Current (A)	Recommended MCB		
		NBN	NCN	NDN
50	0.22	-	1	6
100	0.43	-	2	6
200	0.87	-	3	6
250	1.09	6	4	6
300	1.30	10	4	6
400	1.74	10	6	6
500	2.17	16	10	6
750	3.26	16	10	6
1000	4.35	25	16	10
2500	10.87	63	40	20
5000	21.74	-	63	32
7500	32.60	-	-	50
10000	43.48	-	-	63

Table 19

Three Phase 400V

Transformer Rating (VA)	Primary Current (A)	Recommended MCB		
		NBN	NCN	NDN
500	0.72	-	3	6
750	1.08	6	4	6
1000	1.44	10	6	6
2000	2.88	16	10	6
3000	4.33	25	16	10
4000	5.77	32	20	10
5000	7.21	40	25	16
7500	10.82	63	32	20
10000	14.43	-	50	25
15000	21.64	-	63	32
20000	28.86	-	-	50
25000	36.07	-	-	63

Table 20

Lighting circuit

Although the MCBs prime function is the protection of lighting circuits, they are often used as local control switches as well, conveniently switching on and off large groups of luminaries in shops and factories. The MCB is well able to perform this additional task safely and effectively. Hager MCBs have an electrical endurance of 20,000 on/off operations for rated trips up to and including 32A and 10,000 on/off operations for 40, 50 and 63A rated trips. Account must be taken of the effects of switching inductive loads.

For the protection of lighting circuits the designer must select the circuit breaker with the lowest instantaneous trip current compatible with the inrush currents likely to develop in the circuit.

High Frequency (HF) ballasts are often singled out for their high inrush currents but they do not differ widely from the conventional 50Hz. The highest value is reached when the ballast is switched on at the moment the mains sine wave passes through zero. However, because the HF system is a "rapid start" system whereby all lamps start at the same time, the total inrush current of an HF system exceeds the usual values of a conventional 50Hz system. Therefore where multiple ballasts are used in lighting schemes, the peak current increases proportionally.

Mains circuit impedance will reduce the peak current but will not affect the pulse time.

The problem facing the installation designer in selecting the correct circuit breaker is that the surge characteristic of HF ballasts vary from manufacturer to manufacturer. Some may be as low as 12A with a pulse time of 3mS and some as high as 35A with a pulse time of 1mS. Therefore it is important to obtain the expected inrush current of the equipment from the manufacturer in order to find out how many HF ballasts can safely be supplied from one circuit breaker without the risk of nuisance tripping.

This information can then be divided into the minimum peak tripping current of the circuit breaker, shown in Table below

Circuit Breaker	Circuit breaker rated current								
	6A	10A	16A	20A	25A	32A	40A	50A	63A
B	26	43	68	85	106	136	170	212	268
C	43	71	113	142	177	223	283	354	446
D	85	142	226	283	354	453	566	707	891

Table 21

Minimum peak tripping current

Example:
How many HF ballasts, each having an expected inrush of 20A can be supplied by a 16A type C circuit breaker? From Table 21, 16A type C we have a minimum peak tripping current of 113A.

$$\text{Therefore } \frac{113}{20} = 5$$

i.e. 5 ballasts can be supplied by a 16A type C circuit breaker.

Moulded case circuit breakers

Moulded case circuit breakers have been developed for use in commercial and industrial installations and, as the name implies, the air-break circuit breaker mechanism is housed in a moulded case of non-conducting material which not only provides a frontal protection of at least IP30 but also provides full segregation of all live parts.

The main features of a modern Moulded Case Circuit Breaker (MCCB) are:

1. High breaking capacity and low specific let-through energy, ensuring full operating safety under heavy fault conditions.
2. Simultaneous opening and closing of all main poles.
3. Trip free mechanism.
4. Positive contact indication whereby the toggle always indicates the exact position of the main contacts.
5. Test button which allows periodic testing of the mechanical trips.

MCCBs are intended to be selected, installed and used by skilled or instructed people and as such should comply with and be tested to BS EN 60947-2.

This British Standard, unlike BS EN 60898 which covers circuit breakers for household and similar installations does not set out to standardise the circuit breakers time/current characteristics. It does however give two points at which the time/current characteristics should be verified. The circuit breaker should be able to carry 1.05 times the thermal trip setting current without tripping and when loaded to 1.3 times that current to trip in one hour or less and in two hours or less for rated current above 63A.

I_r = Thermal trip setting.
 I_{cs} = Rated service short circuit capacity.
 I_{cu} = Rated ultimate short circuit capacity.

Category A MCCB Characteristic Curve

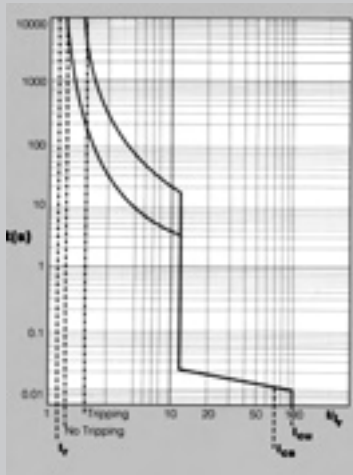

Short-time withstand current I_{cw}

BS EN 60947-2 defines two categories of circuit breakers:

Category 'A' for which no short-circuit trip delay is provided. These are generally the smaller moulded case circuit breakers below 630A with time current characteristics as shown in Fig 12. Category 'A' breakers will trip instantaneously when the short-circuit current is greater than the magnetic trip setting of the circuit breaker.

Category 'A' circuit breakers are suitable for current discrimination but not for time discrimination.

Category 'B' for which, in order to achieve time discrimination, it is possible to delay tripping during short-circuit conditions with values lower than I_{cw} (As shown in Fig 13). These are generally the larger moulded case circuit breakers and air circuit breakers with time current characteristics as shown in Table 23. For moulded case circuit breakers I_{cw} is always lower than the ultimate breaking capacity I_{cu} .

Category B MCCB characteristic curve

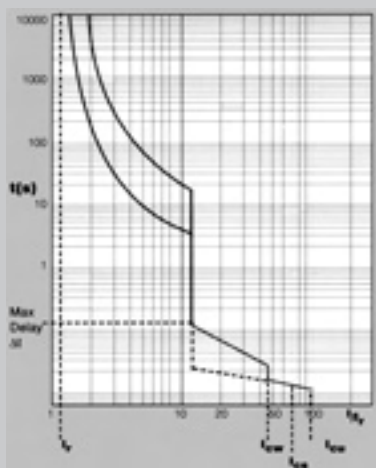

The British Standard gives minimum values of I_{cw} and of the associated time delay. See Table 22

Short time withstand required for I_{cw}		Associated delay
$I_n \leq 2500A$	$I_n > 2500A$	$\Delta t(s)$
$I_{cw} \geq 12I_n$ (min 5kA)	$I_{cw} \geq 30kA$	0.05 minimum value
		0.1)
		0.25) preferred
		0.5) values
		1)

Table 22

Frame (A)	thermal rating I_{th}	rated voltage $U_e(V)$	rated short time withstand I_{cw} (A)	impulse voltage U_{imp} (kV)	insulation voltage U_i (V)	no mechanical operations	no electrical operations
125	125	230/415	1.7*	6	500	6000	6000
250	250	415	3.0*	8	690	6000	6000
400	400	415	4.8*	8	750	16000	16000
630	630	415	7.5*	8	750	16000	16000
800	800	415	9.6*	8	750	16000	16000

* half second rating

Table 23

Breaking Capacity

An attempt has been made to try and make the assigned short-circuit breaking capacities of a circuit breaker more understandable to the specifier and of more practical use to the designer than the old P1 and P2 ratings. The British Standard still specifies two ratings

- I_{cu} : Rated ultimate short-circuit breaking capacity
- I_{cs} : Rated service short-circuit breaking capacity.

Ultimate Short Circuit Breaking Capacity

I_{cu} corresponds in practice to P1 in the former standard and is defined in the same way. This is now covered under test sequence 3, which is:

- Verify the overcurrent releases at $2I_r$;
- Two successive breaks at I_{cu} , cycle 0 - 3 min - CO;
- Dielectric withstand at $2U_e$ (50Hz, 1 min);
- Verify the calibration of the over-current releases.

I_{cu} Represents the maximum short-circuit current which the breaker can break and is to be compared with the prospective fault current at the point of installation:

I_{cu} (Of the device) Must be equal to or greater than the prospective short-circuit at the point of installation.

Service Short-circuit Breaking Capacity

Generally, when a short-circuit occurs (in itself a very rare occurrence) its value is much lower than its calculated value. Nonetheless, it is essential that these lower values of short-circuit are cleared effectively and safely, and that the supply is re-established as quickly as possible. It is for this reason that BS EN 60947-2 has introduced a new characteristic, I_{cs} known as Service Breaking Capacity and generally expressed as a percentage of I_{cu} . The value can be chosen by the manufacturer from 25, 50, 75 or 100%.

I_{cs} must be verified as described under test sequence 2 which is:

- Three successive breaks at I_{cs} with cycle 0 - 3 min - CO - 3 min - CO;
- Dielectric withstand at $2U_i$ (50 Hz, 1 min);
- Temperature rise at I_n ;
- Verify the calibration of the over-current releases.

This establishes I_{cs} as a performance characteristic which can be considered not simply as a breaking capacity (as was the case of P2) but as the ability of the circuit breaker to ensure normal service, even after having disconnected several short-circuits.

The percentage ratio of I_{cs} to I_{cu} is another important aspect for the designer to understand. Our wiring regulations, which are based on IEC 364, give no guidance at the moment on the use of performance characteristic I_{cs} . To comply with these regulations it is only necessary for the ultimate breaking capacity of the protective device to be equal to or greater than prospective fault level: $I_{cu} \geq I_{cs}$.

The selection of the percentage ratio of I_{cs} to I_{cu} to achieve optimum continuity of service depends on the "probable short circuit level". Therefore I_{cs} should be equal to or greater than the probable short circuit level. However for large air circuit breakers it is usual for $I_{cs} = I_{cu}$, i.e. 100% because these devices are usually installed as main incomers to large switchboards where their field of protection is often limited to the switchboard itself. In these conditions the probable I_{cs} will be only slightly less in comparison with the I_{cu} .

It is important for this application to select a device where I_{cs} performance is close to I_{cu} .

While this holds true for large switchboards, designed for high prospective fault levels, it is possible to use lower rated circuit breakers as incomers on panelboards designed for a relatively low prospective fault level. This provided that the service performance level is equal to or greater than the prospective fault level. For example, it is possible to install an H630 moulded case circuit breaker as a main in-comer on a switchboard supplied from a 400kVA transformer because the H630 I_{cs} is greater than the PSCC.

However, for those circuit breakers which are usually installed as outgoers, protecting cables to sub-boards or other loads, a 50% ratio is adequate because studies have shown that when a short-circuit does occur it is nearly always single or two phase and located at the extremity of the protected cable, and is usually less than 25% of the prospective fault level at the origin of the system and, in almost all cases, not greater than 50%. It is therefore a wise precaution, to prolong the working life of the installation, to choose a device having a service performance I_{cs} equal to 50% I_{cu} . It is advisable to base the I_{cs} rating of a MCCB on the psc at the extremity of the circuit that it is protecting.

Temperature Derating

Hager MCCBs are designed and calibrated to carry their rated current and to operate within this designated thermal time/current zone at 40°C. If the ambient temperature around the circuit breaker differs from 40°C then it requires more or less current to operate the thermal trip depending on the ambient temperature variation.

Table 24 shows the variation of the range of the thermal trip as a function of the ambient temperature. The instantaneous magnetic trip is not affected by variations in ambient temperature.

Variation of Thermal Trip Range with Ambient Temperature

Type	In	30°C		40°C		50°C		60°C	
		min	max	min	max	min	max	min	max
125A	16	-	16.0	-	16.0	-	15.4	-	14.0
	20	-	20.0	-	20.0	-	19.2	-	18.0
	25	-	25.0	-	25.0	-	24.0	-	25.5
	32	-	32.0	-	32.0	-	30.7	-	28.8
	40	-	40.0	-	40.0	-	38.4	-	36.0
	50	-	50.0	-	50.0	-	48.0	-	45.0
	63	-	63.0	-	63.0	-	60.5	-	56.7
	80	-	80.0	-	80.0	-	76.8	-	72.0
	100	-	100.0	-	100.0	-	96.0	-	90.0
	125	-	125.0	-	125.0	-	120.0	-	112.5
250A	160	128.0	160.0	128.0	160.0	122.9	153.6	115.2	144.0
	200	160.0	200.0	160.0	200.0	153.6	192.0	144.0	180.0
	250	200.0	250.0	200.0	250.0	192.0	240.0	180.0	225.0
400A	320	256.0	320.0	256.0	320.0	245.8	307.2	230.4	288.0
	400	320.0	400.0	320.0	400.0	307.2	384.0	288.0	360.0
630A	500	400.0	500.0	400.0	500.0	384.0	480.0	360.0	450.0
	630	504.0	630.0	504.0	630.0	483.8	604.8	453.6	567.0
800A	800	640.0	800.0	640.0	800.0	614.4	768.0	576.0	720.0

Table 24

MCCB Technical Tables

Frame type		125	125	250	400	630	800
Rated current at 40°C	Amps	125	125	250	400	630	800
No. of poles		1	3-4	3-4	3-4	3-4	3-4
	height mm	140	140	176	257	273	273*
	width mm	25	75/101	105/140	140/183	210/273	210/273*
	depth mm	74	74	91	103	103	103
Rated voltage Ue	V a.c. (50-60Hz)	500	500	690	690	750	750
	230-240V a.c.	16	25	85	85	85	65
	400-415V a.c.		16	40	45	50	50
	690V a.c.				20	20	20
	250V d.c.	20	20	20	20	20	20
	400V a.c.	100%	100%	100%	100%	100%	50%
Releases							
Rated current (product range)		16-125A	16-125A	160-250A	320-400A	500-630A	800A
Adjustable thermal releases	In	Fixed	0.8-1.0	0.8-1.0	0.8-1.0	0.8-1.0	0.8-1.0
Adjustable magnetic releases	In	Fixed	Fixed	5.0-10.0	5.0-10.0	5.0-10.0	2.0-8.0
Selective category B type					available	available	available
MCCBs BS EN 60947-2					on request	on request	on request
Moulded case switches			✓	✓	✓	✓	✓
Internal accessories							
Shunt trip			✓	✓	✓	✓	✓
Under voltage releases			✓	✓	✓	✓	✓
Auxiliary contacts			✓	✓	✓	✓	✓
Alarm contacts			✓	✓	✓	✓	✓

Table 25

* excludes terminal extension pads

For other control voltages please consult us.

Frame type	Designation	125		250		400		630/800	
		Cat Ref.		Cat Ref.		Cat Ref.		Cat Ref.	
Control voltage		230V	400V	230V	400V	230V	400V	230V	400V
	Shunt trip operating voltage UF = 0.7 to 1.1 Un	HX104E	HX105E	HX104E	HX105E	HX104E	HX105E	HX804	HX805
	Under voltage release Release voltage UF = 0.35 to 0.7 Un Maintaining voltage UF ≥ 0.85 Un	HX114E	HX115E	HX114E	HX115E	HX114E	HX115E	HX814	HX815
	Auxiliary contacts (2 off)	HX122	-	HX122	-	HX122	-	HX822	-
	Auxiliary and alarm	HX123	-	HX223	-	HX223E	-	HX823	-

Table 26

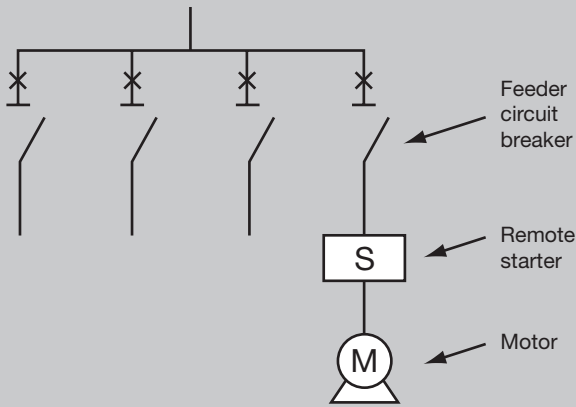

Fig 14

Motor Power Circuit Protection

The selection of the circuit protective device for motor power supply circuits depends in the first instance on the relative physical position of the various circuit elements. The feeder circuit breaker in the switchboard, panelboard or distribution board, the starter with its contactor and thermal overload relay, with perhaps its own isolator or short-circuit protective device (SCPD) and of course the motor.

The feeder circuit breaker, which can be a perfectly standard thermal magnetic breaker, must protect the cable feeding the starter so the normal selection criteria apply. In addition, however, it must be able to withstand the inrush and starting currents of the motor without nuisance tripping. The inrush current, which should not be confused with the starting current, appears at the instant of switch on and could be as great as 10 times the full load current (FLC) of the motor, but with a relatively short pulse time of 20 to 30 milliseconds.

kW	hp	Full load speed rev/min	Full load current A	Direct start	
				Starting current x FLC	Starting torque x FLC
		2800	3.2	6.75	3
		1400	3.5	5.5	2.5
1.5	2	900	3.8	4.5	2.2
		700	4.3	4.0	2.0

Table 27

The starting current of a direct on line (DOL) start squirrel cage motor does vary with the designed speed of the motor - the higher the speed the higher the starting torque and the starting current as a ratio of the FLC. However the FLC is inversely proportional to the design speed of the motor. Table 27 shows typical performance data for average 1.5kw/2hp three phase squirrel cage motors.

The run-up time can vary between one and fifteen seconds depending on the surge of the motor and the type of load the motor is driving.

Clearly then, to accurately select the correct circuit breaker for a motor power supply circuit it is essential to know the correct FLC, the starting current and the run-up time. This information is then plotted against the time/current characteristic curve of the type of circuit breaker (or fuse) selected.

Example

Select an appropriate feeder circuit breaker to supply a 1.5kw 3 phase motor DOL start. FLC 3.5A, starting current 5.5 x FLC, run-up time 6 secs. The circuit breaker must be suitable for fitting into a 3 phase MCB Distribution Board.

Starting current: $3.5 \times 5.5 = 19.25A$ for 6 secs
 Inrush current : $3.5 \times 10 = 35A$

Comparing the data against the time/current characteristics of a type C MCB, Fig 15, we see that at 6 secs the breaker will carry $2 \times I_n$ without tripping. Therefore a 10A MCB would carry 20A for 6 secs. The minimum instantaneous trip for this type C MCB would be 50A.

Therefore the closest protection for this motor feeder circuit would be a 3 Pole 10A type C MCB. A 10A type D could be used providing the 100A maximum instantaneous trip was not a problem. The inrush current would preclude the use of a 10A type B because the minimum instantaneous trip is only 30A. In this case use the next size up, i.e. 16A.

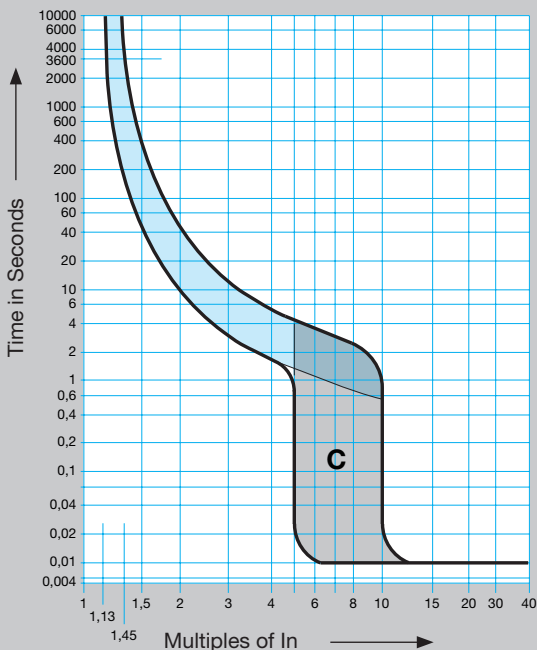

Fig 15

Motor rating	DOL starting conditions	Assisted start conditions
Up to 0.75kW	5 x FLC for 6 secs	2.5 x FLC for 15 secs
1.1 to 7.5 kW	6 x FLC for 10 secs	2.5 x FLC for 15 secs
11 to 75kW	7 x FLC for 10 secs	2.5 x FLC for 15 secs
90 to 160kW	6 x FLC for 15 secs	2.5 x FLC for 20 secs

Table 28

1 Phase 230V DOL Starting

kW	hp	FLC A	Recommended circuit breaker			
			(A) NBN	HN NCN	NDN	Fuse(A)
0.18	0.25	2.8	16	10	10	10
0.25	0.33	3.2	16	10	10	16
0.37	0.5	3.5	16	10	10	16
0.55	0.75	4.8	20	16	16	16
0.75	1.0	6.2	25	20	20	20
1.1	1.5	8.7	40	25	25	25
1.5	2.0	11.8	50	32	32	32
2.2	3.0	17.5	-	50	50	40
3.0	4.0	20	-	63	63	50
3.75	5.0	24	-	-	-	63
5.5	7.5	36	-	-	-	80
7.5	10	47	-	-	-	100

Table 29

3 Phase 400V Assisted Starting Star-Delta

kW	hp	FLC A	Recommended circuit breaker		
			(A) NCN	(A) NDN	HRC fuse (A)
3	4	6.3	16	10	16
4	5.5	8.2	20	10	16
5.5	7.5	11.2	32	16	20
7.5	10	14.4	40	25	25
11	15	21	50	32	32
15	20	27		40	35
18.5	25	32		50	40
22	30	38		63	50
30	40	51			63
37	50	63			80
45	60	76			80
55	75	91			100
75	100	124			160
90	125	154			200
110	150	183			200
132	175	219			250
150	200	240			315
160	220	257			315

Table 30

Tables 28,29,30 and 31 give general recommendations for the selection of circuit breakers and HRC fuses for the protection of motor power circuits and are based on the assumptions shown in Table 28 for a cage motor running at approximately 1400 Rev/Min.

Assisted Start

The selection of a feeder circuit breaker for a motor with an assisted start facility is much the same as for DOL start. The full load running current is the same for both, but the starting current for the assisted start can be less than half, with a subsequent reduction in starting torque. Typical starting current for star-delta start would be 2 to 2 1/2 times FLC, with a run-up time of 15 to 20 seconds depending on the size of the motor and the load driven by the motor. However the transient during changeover still has to be taken into account so selection is often dictated by the instantaneous trip setting of the circuit breaker.

3 Phase 400V DOL Starting

kW	hp	FLC A	Recommended circuit breaker			
			(A) NBN	(A) NCN	(A) NDN	HRC fuse (A)
0.18	0.25	0.87		2		4
0.25	0.33	1.17		3		4
0.37	0.5	1.2		3		4
0.55	0.75	1.8		4		6
0.75	1.0	2.0	10	6	6	6
1.1	1.5	2.6	16	10	6	10
1.5	2.0	3.5	16	10	10	16
2.2	3.0	4.4	20	16	16	16
3.0	4.0	6.3	25	20	20	20
4.0	5.5	8.2	32	25	25	25
5.5	7.5	11.2	50	40	40	32
7.5	10	14.4	63	50	50	40
11	15	21				63
15	20	27				80
18.5	25	32				80
22	30	38				80
30	40	51				100
37	50	63				125
45	60	76				125
55	75	91				160
75	100	124				200
90	125	154				250
110	150	183				315
132	175	219				355
150	200	240				355
160	220	257				355

Table 31

Prospective Short Circuit Current (PSCC)

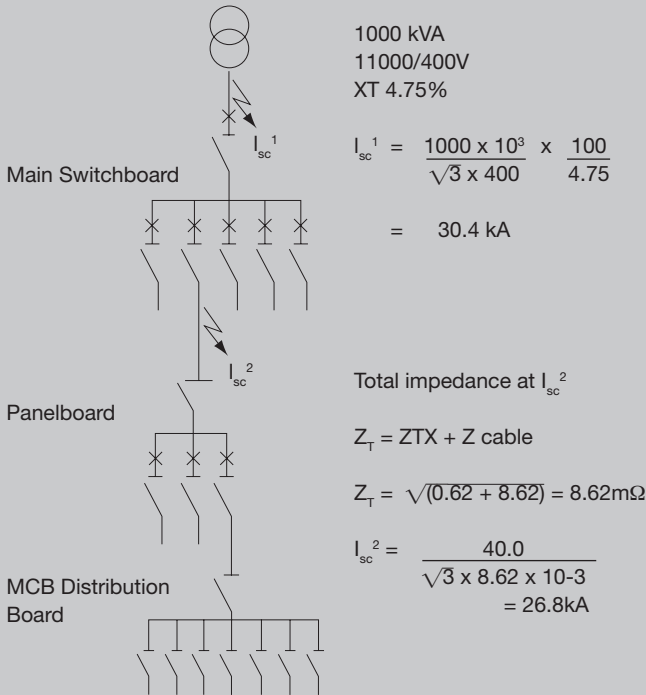

Fig 16

In order to select the correct device for the proper protection against short-circuit current the Wiring Regulations suggest that the prospective short-circuit current at every relevant point of the complete installation shall be determined by calculation or by measurement of the relevant impedances.

Of course this is only necessary if the prospective short-circuit current at the origin of the installation is greater than the breaking capacity of the smallest protective device.

All short-circuit current protective devices must have a breaking capacity equal to or greater than the prospective fault current at the point where they are to be installed

$$I_{cn} \geq \text{Prospective fault current}$$

The relationship between prospective fault current and probable fault current is discussed later.

Prospective Fault Current

The theoretical maximum fault condition at any point in a distribution system is termed the “prospective fault current”. This is the rms value of the current that would flow on the occurrence of a solidly bolted direct fault at that point and pre-supposes that the voltage will remain constant and the ultimate supply source has limitless capacity. Therefore, the prospective fault current is limited by

- The impedance of the high voltage network feeding the supply transformer.
- The impedance of the supply transformer.
- The impedance of the distribution Network from the supply transformer to the point of fault.

In practice the voltage does drop and the fault does have impedance and moreover the protective devices have impedance. Therefore the prospective current is theoretical and cannot be exceeded.

The severity of the short-circuit fault is also controlled by the “Power Factor” which like the fault current is determined by the circuit conditions up to the point of fault. However, the short-circuit power factor is not to be confused with the load power factor which is determined by the characteristics of the load itself.

Power Factor is effectively a measure of stored energy in the system. Hence if the power factor is low, there is a considerable amount of stored energy to be dissipated during the fault clearance. Also there will be a degree of asymmetry of the current wave due to the presence of a dc component.

Asymmetrical Short Circuit Current

When a short-circuit occurs in a circuit the resistance of which is negligible compared with the inductive reactance, the resulting short-circuit current has a dc component. This dc component has a maximum value when the short-circuit occurs at the instant at which the circuit voltage is zero. (see Fig 17). Since in a three phase system there are six voltage zeros per cycle, it is certain that there will be considerable asymmetry in the current flowing in at least one of the phases. If the fault occurs at any other point of the voltage wave, the resultant short-circuit is partially offset, that is to say, it contains a dc component of reduced magnitude.

The asymmetrical current consists of the symmetrical short-circuit current superimposed on or offset by a dc component which decreases exponentially to practically zero within a few cycles. The asymmetrical short-circuit current peak determines the maximum mechanical stress to which the equipment may be subjected.

The maximum peak current is about 1.75 times the peak symmetrical current, or putting it another way $1.75 \times \sqrt{2}$, i.e. 2.5 times the rms value of the symmetrical short-circuit current.

Circuit breakers are selected so that the breaking capacity is always equal to or greater than the rms value calculated at the relevant point of installation. The making capacity is generally ignored, the assumption being that it will be in line with the level of peak current normally associated with the calculated rms current.

For example a circuit breaker with a breaking capacity of 15kA rms will have a making capacity of $15 \times 2 = 30\text{kA}$ peak (see Table 32)

This assumes a short-circuit power factor of 0.3.

Ratio n between making and breaking capacity

Breaking capacity I_{cn} (A)	Standard power factor	Minimum making capacity ($n \times I_{cn}$)
≤ 1500	0.95	$1.41 \times I_{cn}$
$> 1500 \leq 3000$	0.9	1.42
$> 3000 \leq 4500$	0.8	1.47
$> 4500 \leq 6000$	0.7	1.53
$> 6000 \leq 10000$	0.5	1.7
$> 10000 \leq 20000$	0.3	2.0
$> 20000 \leq 50000$	0.25	2.1
> 50000	0.2	2.2

Table 32

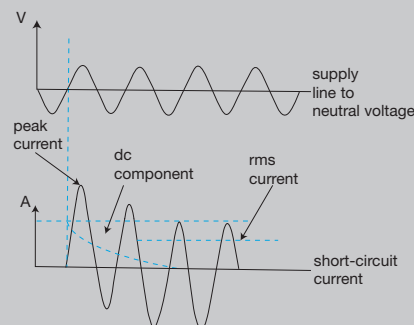

Fig 17

Prospective Fault Current

Calculation of Prospective Short Circuit Current

Several excellent proprietary computer programs are now available for calculating the prospective fault level at any point in the installation. They are also able to select the correct size and type of cable and match this with the correct circuit protective device.

Estimation of Prospective Fault Current

Actually calculating prospective short-circuit current is not in itself difficult but it does require basic data which is not always available to the electrical installation designer.

It is therefore usual to use a simple chart as shown in Fig 18 to estimate the prospective short circuit current. This type of chart always gives a prospective fault level greater than that which would have been arrived at by calculation using accurate basic data. Therefore it is safe to use but sometimes may result in an over engineered system.

Conductor Cross Sectional Area (mm²) (Cu)

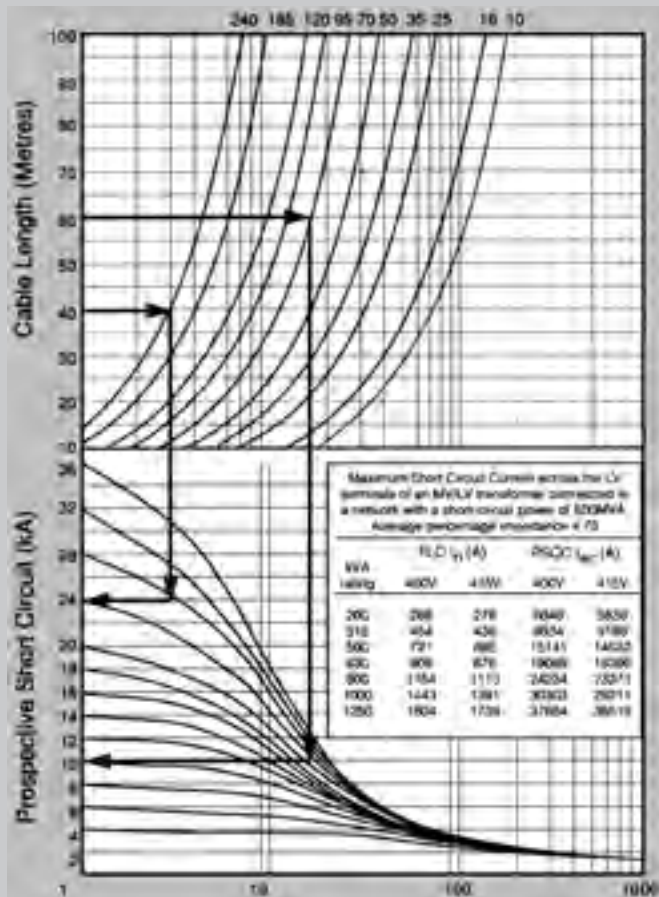

Fig 18

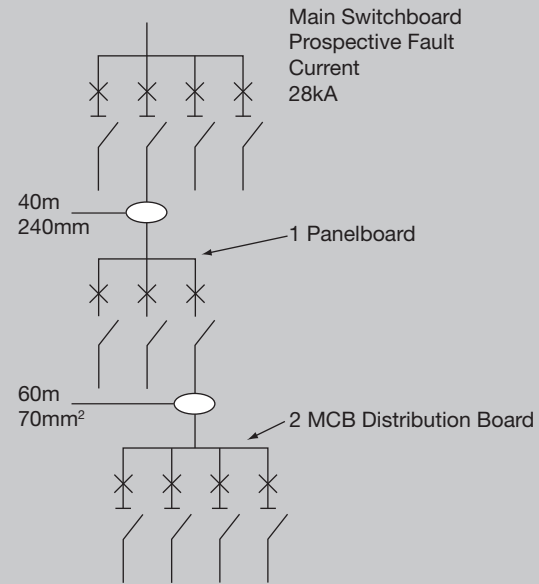

Fig 19

Example

- 1 Project 40m of cable length across on to the 240mm² cable curve. From this point project down onto the 28kA curve. From this point projecting across we note that the prospective fault level at the panelboard is 24kA.
- 2 Project 60m of cable length across onto the 70mm² cable curve. From this point project down on to the 24kA curve. From this point projecting across we see that the prospective fault level at the MCB distribution board is 10kA.

Prospective Short Circuit Current in Domestic Installations

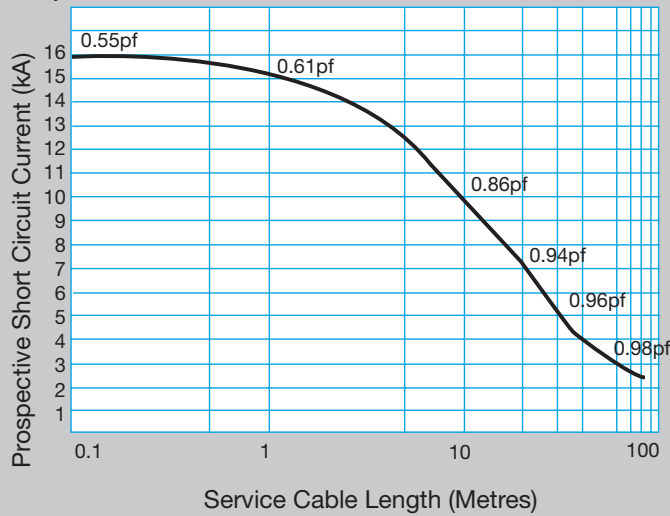

Fig 20

On single phase supplies up to 100A the electricity supply companies generally recommend that any installation is designed to cope with the maximum system fault level of the distributing main.

The declared fault level of the LV distributing main is 16kA (0.55 pf) Some supply companies do, however, accept that the impedance of the service cable may be taken into account as this is unlikely to change during the lifetime of the installation. The graph in Fig 20 shows for a standard service arrangement using a 25mm² service cable, the maximum prospective fault current at the consumer units incoming terminals, depending on the length of service cable from the point of connection to the LV distributing main.

The service cable length for domestic and similar installations may be taken as the distance from the service position in the consumer's premises to the boundary of the plot, assuming that the distributing mains cable is in the adjacent footpath.

Note: Hager consumer units with the following main incoming devices are tested to BS EN 60439-3 annex ZA - 16kA conditional short circuit.

Incoming device	Cat Ref
63A 2P switch disconnecter	SB263U
100A 2P switch disconnecter	SB299U
63A 2P RCCB	CDC263U
80 + 100A 2P RCCB	CD, CN
	280U + 284U
40A 2P RCCB / Garage Boards	CDC240U

Probable Short-Circuit Current

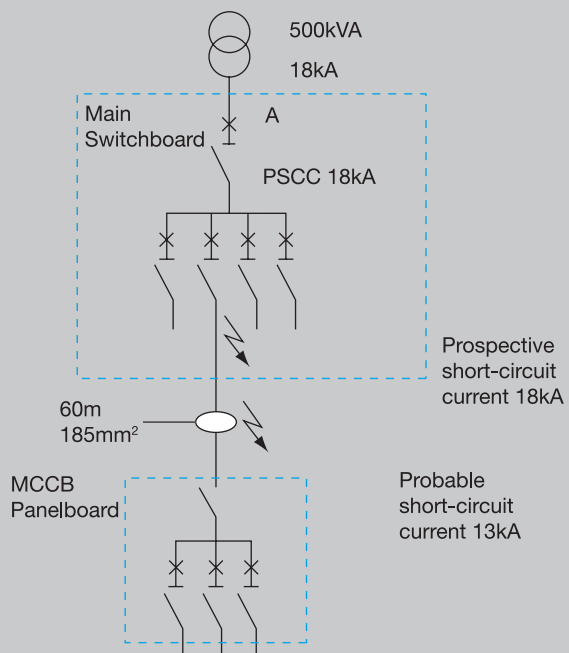

Fig 21

On page 3.43 the relationship between probable short-circuit current and service short-circuit breaking capacity is explained. The probable short circuit is the type of short circuit which is most likely to occur; this is nearly always at the extremity of the protected cable and more often than not a single phase or earth fault. Fig 21 shows a typical 3 phase 4 wire 400V system fed by a 500 kVA transformer. The transformer is adjacent to the main switchboard so the prospective short-circuit current (PSC) on the main switchboard busbars is estimated as 18kA. The probable short-circuit current on the panelboard feeder circuit is estimated as 13kA, if it were a 3 phase symmetrical fault, or 6.5kA for a phase to neutral fault, which in fact would be the most likely type of fault. (Note: when estimating a phase to neutral prospective short-circuit current the length of conductor is doubled.)

Therefore for this application the main switchboard incoming circuit breaker

(A) Should have an $I_{cs} \geq 18kA$ and an $I_{cu} \geq 18kA$.

The panelboard feeder circuit breaker (B) Should have an $I_{cs} \geq 18kA$ and an $I_{cu} \geq 13kA$.

Prospective Short Circuit Current (PSC)

Co-ordination between circuit protective devices

The proper co-ordination of two circuit protective devices is essential in all installations in order to fulfil the requirements of the Wiring Regulations which set out to ensure the safe continuity of supply of electrical current under all conditions of service. If a fault does occur, the circuit protective device nearest the fault should operate, allowing the device immediately upstream to continue to supply healthy circuits. This is called discrimination.

Sometimes the upstream device is selected to protect the downstream device(s) against high prospective short circuit currents and will operate to provide this protection should the actual short circuit current rise to a level which cannot be handled by the device nearest the fault. This is called back-up protection and devices should be so chosen as to allow discrimination up to the point the back-up device takes over.

Discrimination

Discrimination, which is sometimes called selectivity, is the co-ordination of two automatic circuit protective devices in such a way that a fault appearing at any given point in an installation is cleared by the protective device installed immediately upstream of the fault and by that device alone.

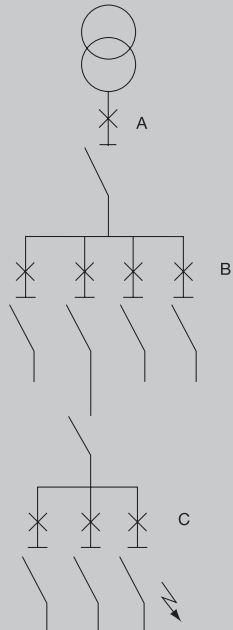

Fig 22

Example

A fault occurs downstream of final sub-circuit device "C". All other protective devices remain closed ensuring continuity of supply to the rest of the installation.

When this ideal situation is achieved under all conditions it is called "total discrimination".

Discrimination between two protective devices can be based on either the magnitude of the fault which is called "current discrimination" or the duration of the time the upstream device can withstand the fault current; this is called "time discrimination".

Current discrimination

In order to achieve "current discrimination" in a distribution system it is necessary for the downstream device to have a lower continuous current rating and a lower instantaneous tripping value than the upstream device. Current discrimination increases as the difference between the continuous current ratings of the upstream and downstream devices increases.

A simple way of checking current discrimination at both overload and short-circuit conditions is to compare the time/current characteristic curves of both devices plotted to the same scale. Transparency overlays, if available, make this task much easier (see Fig 23). For this example the time/current characteristics of a 32A type 'B' circuit breaker complying with BS EN 60898, with a 100A category 'A' circuit breaker to BS EN 60947-2 are checked for current discrimination.

Because the thermal characteristic curve of the upstream circuit breaker clears the knee of the characteristic curve of the smaller downstream breaker, it can be said that overload discrimination is achieved under all conditions. However because the instantaneous characteristic curves cross at 0.01 sec, short-circuit discrimination is limited up to the point they cross, which in this case is approximately 2.7kA. The point at which the two time/current characteristics cross is called the limit of discrimination or selectivity. In this example the level of discrimination I_s is 2.7kA, so we only have partial discrimination between these two devices.

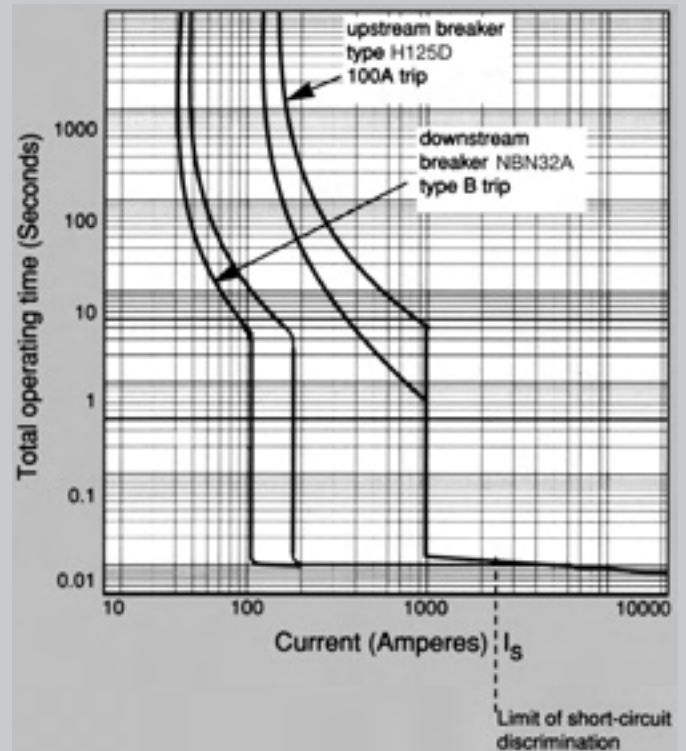

Fig 23

Time discrimination

Time discrimination is achieved by delaying the opening of the upstream circuit breaker until the downstream circuit breaker has opened and cleared the fault. The total clearing time of the downstream circuit breaker must be less than the time setting of the upstream circuit breaker and the upstream circuit breaker must be able to withstand the fault current for the time setting period. Therefore the upstream circuit breaker must be a category 'B' breaker which has been designed and tested for this purpose.

To determine time discrimination it is only necessary to compare the time/current characteristic curves of the two devices to ensure that no overlap occurs.

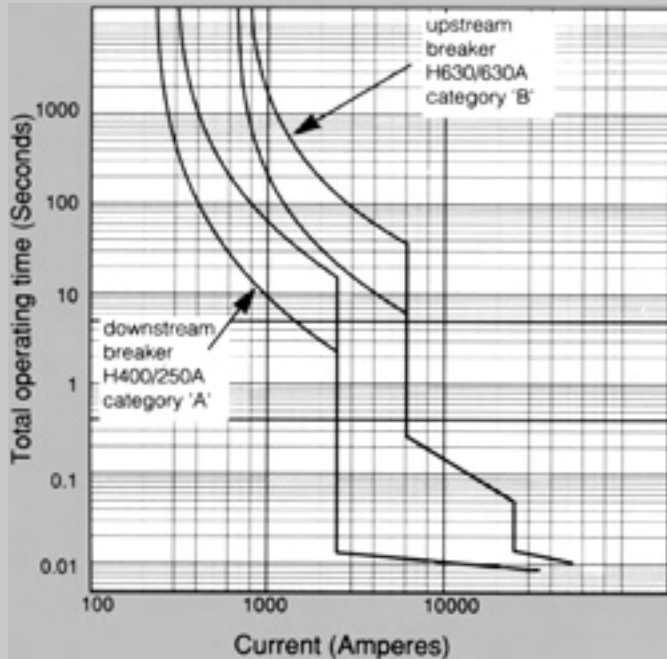

Fig 24

Short circuit discrimination

A more accurate way of checking the discrimination between two circuit protective devices at short circuit levels is to compare the energy let-through of the downstream device with the no-tripping or pre-arcing energy levels of the upstream device.

In order to check current discrimination at short circuit levels between:

Fuse upstream - fuse downstream

It is only necessary to compare the I^2t values of each fuse. This information is usually available in very simple tabular form (see Table 33). If the total let-through energy (I^2t) of the downstream fuse is less than the pre-arcing energy (I^2t) of the upstream fuse, then total discrimination is achieved at short-circuit levels.

Fuse I²t characteristics

Rated current Amperes	Pre-arcing I ² t kA ² s	Total I ² t kA ² s
6	0.01	0.025
10	0.07	0.25
16	0.17	0.45
20	0.31	0.90
25	0.62	1.90
32	1.00	3.0
40	2.1	8.0
50	7.0	17
63	11	30
80	22	70
100	39	100
125	62	170
160	101	300
200	190	500
315	480	1100
400	800	2100
500	1100	3100
630	1800	5000

Table 33

MCB Total let-through energy

MCB In	Total let-through energy kA ² S at PSCC		
	3kA	6kA	10kA
6	5.9	10.5	15
10	6.5	12.2	21.5
16	8.0	17.5	30
20	8.8	19.5	34
25	10	21	38
32	11	24	42
40	12.5	29	50
50	15	34	61
63	16	38	72

Table 34

Fuse upstream - Circuit breaker downstream. The same procedure applies to fuse/circuit breaker as it does to fuse/fuse association to check current discrimination.

While for all practical purposes, a desk top study of time/current and let-through energy (I²t) characteristics are perfectly adequate, the British Standards for circuit breakers do recommend testing to confirm the results. With this in mind Hager have prepared a complete list of discrimination levels for all its circuit protective devices.

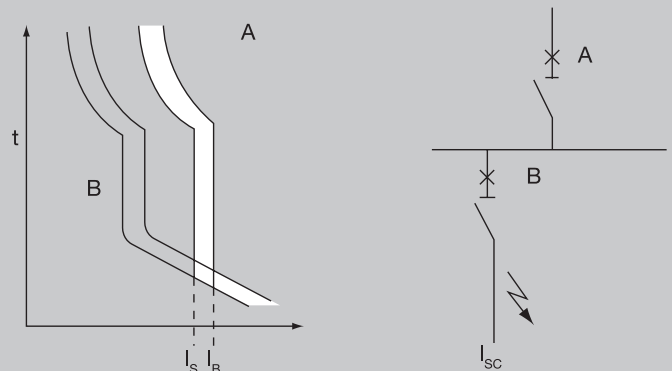

Fig 25 Back-up protection co-ordination

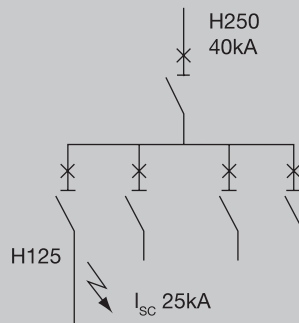

Fig 26

Back-up protection

Sometimes known as cascading, when the energy limiting capacity of an upstream breaker is used to allow the use of a downstream circuit breaker having a short circuit breaking capacity (I_{cu}) lower than the prospective fault level at the point at which it is installed. Table 35 shows the prospective fault level achieved with cascading.

It should be noted that when two circuit protective devices are used in association to improve the short-circuit capacity of the downstream device, total selectivity can never be achieved up to the assigned breaking capacity of the association.

The upstream device must at some point operate to provide the necessary protection to the downstream circuit breaker. This point, which is known as the take-over current, must not be greater than the rated short-circuit capacity of the downstream circuit breaker alone. It therefore follows that the limit of selectivity I_s will be less than the take-over current I_B. See Fig 25.

Example

A panelboard is to be installed at a point where the prospective fault level is 25kA. 250A incoming and 16A TP outgoing circuits. Select the lowest cost circuit breakers which may be used. See Fig 26.

Incoming - Hager H250 MCCB having an I_{cu} of 40kA.

From Table 35 we see we can select a Hager H125 MCCB having an I_{cu} of 16kA to BS EN60947-2 but enhanced to 30kA with cascading.

Co-ordination

Definition

This allows circuit breakers of lower breaking capacity than the PSCC to be installed. The principle is that two breakers operating in series will clear a larger fault and that energy let through by the upstream breaker will not damage the down stream device.

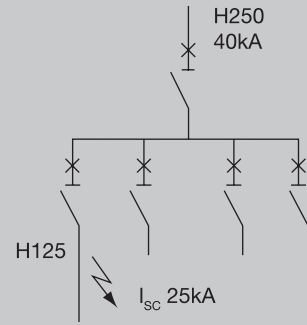

Fig 27

Protection Devices

Circuit breaker to circuit breaker back-up protection

Upstream device	125A Frame MCCB	250A Frame MCCB	400A Frame MCCB	630A Frame MCCB	800A Frame MCCB
Downstream Device					
6kA MCBs MTN	16	20			
10kA MCBs NBN, NCN, NDN	16	20			
125A frame MCCB		30	30	30	30
250A frame device			45	50	50
400A frame device				50	50
630A frame device					

■ Please consult us

Table 35

Fuse to MCCB back-up protection

Upstream

Downstream	Device type	BS88 Gg 250A	BS88 Gg 315A	BS88 Gg 400A	BS88 Gg 630A	BS88 Gg 800A	BS88 Gg 1000A
	125A frame	80kA					
	160A frame		80kA	80kA			
	250A frame			80kA	80kA		
	400A frame				80kA	80kA	
	630A frame						80kA

Table 36

Prospective fault levels to which selectivity is achieved.

BS EN 947-2 Curve	NCN									NDN								
	10kA			15kA						10kA								
	C									D								
In	6A	10A	16A	20A	25A	32A	40A	50A	63A	6A	10A	16A	20A	25A	32A	40A	50A	63A
MTN/NB																		
6A			0.12	0.15	0.19	0.24	0.3	0.38	0.47		0.15	0.24	0.3	0.38	0.48	0.6	0.75	0.95
10A				0.15	0.19	0.24	0.3	0.38	0.47			0.24	0.3	0.38	0.48	0.6	0.75	0.95
16A					0.19	0.24	0.3	0.38	0.47					0.38	0.48	0.6	0.75	0.95
20A						0.24	0.3	0.38	0.47						0.48	0.6	0.75	0.95
25A							0.3	0.38	0.47							0.6	0.75	0.95
32A								0.38	0.47								0.75	0.95
40A									0.47									0.95
NC/MLN																		
0.5A	0.05	0.08	0.12	0.15	0.19	0.24	0.3	0.38	0.47	0.09	0.15	0.24	0.3	0.38	0.48	0.6	0.75	0.95
1A	0.05	0.08	0.12	0.15	0.19	0.24	0.3	0.38	0.47	0.09	0.15	0.24	0.3	0.38	0.48	0.6	0.75	0.95
2A	0.05	0.08	0.12	0.15	0.19	0.24	0.3	0.38	0.47	0.09	0.15	0.24	0.3	0.38	0.48	0.6	0.75	0.95
3A	0.05	0.08	0.12	0.15	0.19	0.24	0.3	0.38	0.47	0.09	0.15	0.24	0.3	0.38	0.48	0.6	0.75	0.95
4A		0.08	0.12	0.15	0.19	0.24	0.3	0.38	0.47	0.09	0.15	0.24	0.3	0.38	0.48	0.6	0.75	0.95
6A			0.12	0.15	0.19	0.24	0.3	0.38	0.47		0.15	0.24	0.3	0.38	0.48	0.6	0.75	0.95
10A				0.15	0.19	0.24	0.3	0.38	0.47			0.24	0.3	0.38	0.48	0.6	0.75	0.95
16A					0.19	0.24	0.3	0.38	0.47					0.38	0.48	0.6	0.75	0.95
20A						0.24	0.3	0.38	0.47						0.48	0.6	0.75	0.95
25A							0.3	0.38	0.47							0.6	0.75	0.95
32A								0.38	0.47								0.75	0.95
40A									0.47									0.95
ND																		
6A				0.15	0.19	0.24	0.3	0.38	0.47			0.24	0.3	0.38	0.48	0.6	0.75	0.95
10A						0.24	0.3	0.38	0.47					0.38	0.48	0.6	0.75	0.95
16A								0.38	0.47						0.48	0.6	0.75	0.95
20A									0.47							0.6	0.75	0.95
25A																	0.75	0.95
32A																		0.95

Table 37

Circuit Breaker Discrimination Charts

MCCB to MCCB

In	A	H125							H250					H400			H630 / H800				
		16	20	25	32	40	50	63	80	100	125	160	200	250	250	320	400	400	500	630	800
H125	16			0.9	1	1	1	0.95	1	1.1	1.3	1.6	2	2.5	2.3	3	3.4	5.6	6.4	8.3	8.3
	20				1	1	1	0.95	1	1.1	1.3	1.6	2	2.5	2.3	3	3.4	5.6	6.4	8.3	8.3
	25					1	1	0.95	1	1.1	1.3	1.6	2	2.5	2.3	3	3.4	5.6	6.4	8.3	8.3
	32						1	0.95	1	1.1	1.3	1.6	2	2.5	2.3	3	3.4	5.6	6.4	8.3	8.3
	40							0.95	1	1.1	1.3	1.6	2	2.5	2.3	3	3.4	5.6	6.4	8.3	8.3
	50								1	1.1	1.3	1.6	2	2.5	2.3	3	3.4	5.6	6.4	8.3	8.3
	63									1.1	1.3	1.6	2	2.5	2.1	2.5	3.4	5.6	6.4	8	8
	80										1.3	1.6	2	2.5	2	2.5	3.4	5.6	6.4	8	8
	100											1.6	2	2.5	2	2.5	3.4	5.6	6	8	8
	125												2	2.5	2	2.5	3.4	5.6	6	8	8
H250	160												2.5	2	2.5	3.4	4	4	4.5	4.5	
	200														2.4	3.4	4	4	4.5	4.5	
	250														2.4	3.4	4	4	4.5	4.5	
H400	250															2.4	3.4	4	4	4	4
	320																3.4	4	4	4	4
	400																		4	4	
H630	400																			4.4	4.4
	500																				
	630																				
	800																				

Table 39

Circuit Breaker Z_s Values & Energy Let Through

Earth loop impedance (Z_s) values for MCBs & MCCBs

Below are the maximum permissible values of Z_s to obtain disconnection in 0.4 & 5 seconds

Type	Rated trip In	Max let-through energy (kA ² s) at PSCC			Max Z_s (ohms)		
		3kA	6kA	10kA	0.4 Secs	5 Secs	
MTN/	6	5.9	10.5	15	8	8.8	
NBN	10	6.5	12.2	21.5	4.8	5.33	
B curve	16	8.0	17.5	30	3	3.33	
	20	8.8	19.5	34	2.4	2.66	
	25	10	21	38	1.92	2.14	
	32	11	24	42	1.5	1.66	
	40	12.5	29	50	1.2	1.33	
	50	15	34	61	0.96	1.06	
	63	16	38	72	0.76	0.84	
	NCN/HM	0.5	0.01	0.01	0.01	48	120
	C curve	1	4.0	7.0	10	24	53
		2	4.0	7.0	10	12	26
3		5.0	10.0	15	8	18.78	
4		5.9	10.5	15	6	13.56	
6		5.9	10.5	15	4	8.8	
10		6.5	12.2	21.5	2.4	5.33	
16		8.0	17.5	30	1.5	3.33	
20		8.8	19.5	34	1.2	2.66	
25		10	21	38	0.96	2.14	
32		11	24	42	0.75	1.66	
40		12.5	29	50	0.6	1.33	
50		15	34	61	0.48	1.06	
63		16	38	72	0.38	0.84	
	80				0.30	0.66	
	100				0.24	0.53	
NDN	6	5.9	10.5	15	2	8.8	
D curve	10	6.5	12.2	21.5	1.2	5.33	
	16	8.0	17.5	30	0.75	3.33	
	20	8.8	19.5	34	0.6	2.66	
	25	10	21	38	0.48	2.14	
	32	11	24	42	0.37	1.66	
	40	12.5	29	50	0.3	1.33	
	50	15	34	61	0.24	1.06	
	63	16	38	72	0.19	0.84	

Table 40

Type	Rated trip In	Max Z_s (ohms)	
		0.4 secs	5 secs
H125 fixed mag. trip	16	0.2	1.9
	20	0.2	1.5
	25	0.2	1.2
	32	0.2	0.94
	40	0.2	0.75
	50	0.2	0.6
	63	0.2	0.48
	80	0.2	0.38
	100	0.2	0.3
	125	0.2	0.24
H 250 mag. trip set to max	160	0.125	0.125
	200	0.10	0.10
	250	0.08	0.08
H 250 mag. trip set to min	160	0.25	0.25
	200	0.20	0.20
	250	0.16	0.16
H 400 mag. trip set to max	320	0.06	0.06
	400	0.05	0.05
H 400 mag. trip set to min	320	0.13	0.13
	400	0.10	0.10
H 800 mag. set to max	630	0.05	0.05
	630	0.03	0.03
	800	0.03	0.03
H 800 mag. trip set to min	630	0.10	0.10
	630	0.06	0.06
	800	0.05	0.05

Table 41

These values have been calculated using the formula $Z_s = U_{oc}/I_a$ taken from appendix 3 of BS EN7671: 1992, taking into account the 20% tolerance stated in section 8.3.3.1.2 of BS EN 60947-2. U_{oc} is the open circuit voltage of the REC transformer taken at 240V. I_a is the current causing operation of the protective device within the specified time. Calculate from $I_m \times 1.2$.

Full table as Apps guide (Table 27)

Single module RCBO characteristics

- Single pole overcurrent protection
- Single pole switching (solid neutral)
- Positive contact indication
- Neutral lead - 700mm long

Current rating	Ambient temperature (°C)						
	30°C	35°C	40°C	45°C	50°C	55°C	60°C
6A	6	5.9	5.8	5.7	5.6	5.5	5.4
10A	10	9.8	9.7	9.5	9.3	9.2	9.0
16A	16	15.7	15.5	15.2	14.9	14.7	14.4
20A	20	19.7	19.3	19.0	18.7	18.3	18.0
25A	25	24.6	24.2	23.8	23.3	22.9	22.5
32A	32	31.5	30.9	30.4	29.9	29.3	28.8
40A	40	39.3	38.6	38.0	37.3	36.6	36.0
45A	45	44.2	43.5	42.8	42.0	41.2	40.5
50A	50	49.2	48.3	47.5	46.7	45.8	45.0

Technical specification

Standard / approvals: BS EN61009
 Type tested KEMA up to 50A
 ASTA up to 40A
 Nominal voltage: 127/230VAC (-6% +10%)
 Frequency: 50/60Hz
 Sensitivity: 10mA / 30mA - AC
 Breaking capacity: 6kA or 10kA (on request)
 Temperature: Working -50°C to +40°C
 Storage -50°C to +80°C
 Mechanism: Trip free
 Endurance: Electrical - 4000
 Mechanical - 20000

Fuse carriers – characteristics

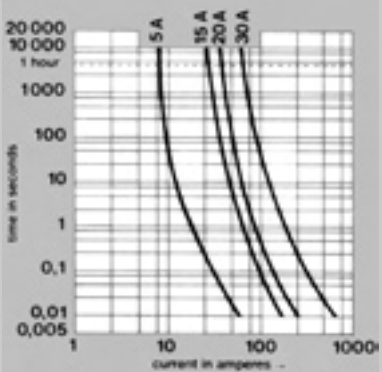
Designation	Characteristics	Width in 17.5mm	Colour code	Cat Ref.	HRC Cartridge Fuses
Fuse carriers for BS 1361 fuses	5A-230V	1	White	L113	 <p>time/current characteristics for HRC fuse links BS 1361 : 1971 : 5, 15, 20, 30 A</p> 
	15A-230V	1	Blue	L115	
	20A-230V	1	Yellow	L116	
	30A-230V	1	Red	L118	
for BS 88 fuses	32A-maxi-400V	1	-	L50145	
Accessories					
(HRC cartridge fuses)	A x B x C (mm)				
Fuse links to BS 1361	5A : 23 x 6.35 x 4.8		White	L153	
	15A : 26 x 10.32 x 6.4		Blue	L155	
	20A : 26 x 10.32 x 6.4		Yellow	L156	
	30A : 29 x 12.70 x 8.0		Red	L158	
Fuse links to BS 88	2A : 29 x 12.70 x 8.0			L171	
	4A : 29 x 12.70 x 8.0			L172	
	6A : 29 x 12.70 x 8.0			L173	
	8A : 29 x 12.70 x 8.0			L174	
	10A : 29 x 12.70 x 8.0			L175	
	16A : 29 x 12.70 x 8.0			L176	
	20A : 29 x 12.70 x 8.0			L177	
	25A : 29 x 12.70 x 8.0			L178	
	32A : 29 x 12.70 x 8.0			L179	

Connection capacity:

- Top: 16□ Rigid conductor
- Bottom: 10□ Flexible conductor or busbar

Table 42

Residual current devices

A residual current device (RCCB) is the generic term for a device which simultaneously performs the functions of detection of the residual current, comparison of this value with the rated residual operating value and opening the protected circuit when the residual current exceeds this value.

For fixed domestic installations and similar applications we have two types:

- Residual current operated circuit-breaker without integral over-current protection (RCCB's) which should comply with the requirements of BS EN 61008
- Residual current operated circuit-breaker with integral over-current protection (RCBO's) which should comply with the requirements of BS EN 61009

Both RCCB's and RCBO's are further divided into types depending on their operating function :-

Type AC For which tripping is ensured for residual sinusoidal alternating currents, whether suddenly applied or slowly rising. Marked with the symbol.



Type A For which tripping is ensured for residual sinusoidal alternating currents and residual pulsating direct currents, whether suddenly applied or slowly rising. Marked with the symbol.



Type S For selectivity, with time-delay. Marked with the symbol.



RCCB's must be protected against short-circuits by means of circuit-breakers or fuses. RCBO's have their own in built short-circuit protection, up to it's rated value.

The drawing opposite shows how a torroid is located around the line and neutral conductors to measure the magnetic fields created by the current flowing in these conductors. The sum of the magnetic fields set up by these currents (which takes into consideration both the magnitude and phase relationship of the currents) is detected by the torroid.

In a normal healthy circuit the vector sum of the current values added together will be zero. Current flowing to earth, due to a line earth fault, will return via the earth conductor, and regardless of load conditions will register as a fault. This current flow will give rise to a residual current (I_{res}) which will be detected by the device.

It is most important that the line and neutral conductors are passed through the torroid. A common cause of nuisance operation is the failure to connect the neutral through the device.

RCCBs work just as well on three phase or three phase and neutral circuits, but when the neutral is distributed it must pass through the torroid.

RCCBs are not suitable for use on dc systems and unearthed networks.

RCCBs – domestic installation

RCCBs can be installed in two ways:

1. Whole house protection.
2. Selective protection.

Whole house protection is provided typically by a consumer unit where the RCCB device serves as the main switch. Although very popular this suffers from a disadvantage: all circuits are disconnected in the event of fault. Selective protection can be provided by associating the RCCB with identified high risk circuits by adopting one or more of the following:

Principle

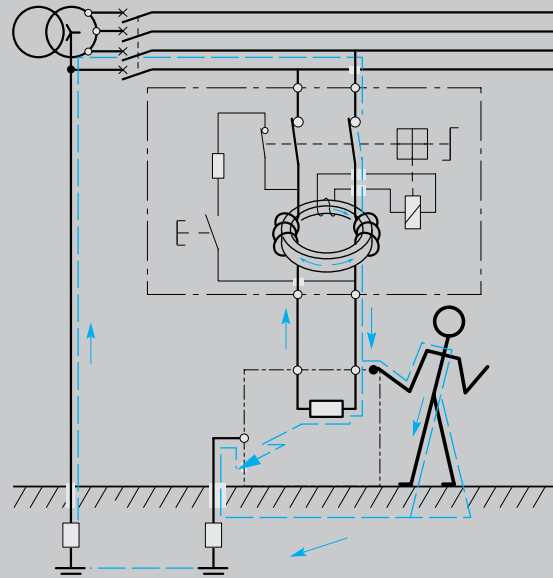

Fig 28

Current flowing through torroid in healthy circuit

$$I_{res} = I_1 - I_2 = 0$$

Current flowing through torroid in circuit with earth fault I₃

$$I_{res} = I_1 - I_2 + I_3 = I_3$$

- Split busbar consumer unit:
All circuits are fed via an overall isolator and selected circuits fed additionally via the RCCB. Typical circuits fed direct are lighting, freezer, storage heating; and circuits fed via the RCCB are socket outlets, garage circuits. This concept minimises inconvenience in the event of fault.

Individual RCBO

each separate final circuit requiring protection by a RCD can be supplied through an RCBO. This method provides the best solution for minimising inconvenience.

Nuisance Tripping

All Hager RCCBs incorporate a filtering device preventing the risk of nuisance tripping due to transient voltages (lightning, line disturbances on other equipment...) and transient currents (from high capacitive circuit).

Pulsating DC Fault Current Sensitive

Increasingly, semi-conductors are also extensively used in computers, VDUs, printers, plotters... all of which may be fed from the mains electrical supply. The presence of semi-conductors may result in the normal sinusoidal ac waveform being modified. For example, the waveform may be rectified or, as in asymmetric phase control devices, the waveform may be chopped. The resulting waveforms are said to have a pulsating dc component.

In the event of an earth fault occurring in equipment containing semi-conductor devices, there is a probability that the earth fault current will contain a pulsating dc component.

Standard type AC may not respond to this type of earth fault current and the intended degree of protection will not be provided.

Use of RCCBs

RCCBs offer excellent protection against earth fault currents; the main areas of application being as follows:

- **Z_s value too high to allow disconnection in the required time**
Where the overcurrent protection or a circuit breaker cannot provide disconnection within the specified time because the earth fault loop impedance is too high the addition of RCCB protection may well solve the problem without any other change in the system. Because of its high sensitivity to earth fault current and its rapid operating time, in most cases the RCCB will ensure disconnection within the specified time. This is achieved without any detriment to overcurrent discrimination because, unlike the situation in a fuse based system, the increased sensitivity is obtained without increasing sensitivity to overcurrent faults. Use of RCCBs in this way can be particularly useful for construction sites and bathrooms where disconnection times are more stringent than for standard installations. (Construction sites - 0.2s at 220-277V, bathrooms - 0.4s).

The limitation to this technique is the requirement that the rated residual operating current multiplied by Z_s should not exceed 50V. This is to avoid the danger of exposed conductive parts reaching an unacceptably high voltage level.

Residual current protection can even be added to a completed distribution system where the value of Z_s is excessive, either because of a design oversight or subsequent wiring modification.

- **Protection against shock by direct contact**
So far we have considered shock by indirect contact only. Direct contact is defined thus:

Direct contact - contact of persons or livestock with live parts which may result in electric shock. The consideration here is not the hazard of parts becoming live as a result of a fault but the possibility of touching circuit conductors which are intentionally live.

RCCBs, although affording good protection against the potentially lethal effects of electric shock, must not be used as the sole means of protection against shock by direct contact. The Electricity at Work Act recommends the use of RCCBs, "...danger may be reduced by the use of a residual current device but states that this should be "...considered as a second line of defence". The Wiring Regulations defines the other measures that should be taken i.e.

- Insulation of live parts.
- Barriers or enclosures.
- Obstacles.
- Placing live parts out of reach.

Additionally an RCCB used for this purpose should have:

- A sensitivity of 30mA
- An operating time not exceeding 40mS at a residual current of 150mA.

The specified sensitivity is based on research that has been carried out to estimate the effect various levels and duration of current can have on the human body. This experience is summarised in a graph shown in 'IEC 479-1: Effects of current passing through the human body'. A simplified version of this graph is shown opposite. It shows that very small currents can be tolerated for reasonably long periods and moderate currents for very short periods. It can be seen, for instance, that 100mA for 100mS or 20mA for 500mS will not normally cause any harmful effect. 200mA for 200mS or 50mA for 500mS which are in Zone 3, would be more dangerous; and shock levels in Zone 4 carry a risk of lethal consequences.

The tripping characteristic for a 30mA RCCB is also shown in the graph. It shows the level of current required to cause the RCCB to trip, for example; 50mA will cause a trip but not 10mA. Comparing its characteristic with the various zones on the graph it can be seen that the 30mA RCCB gives a very good measure of protection against the hazards associated with electric shock. Where a higher level of protection is required, for example in laboratories, 10mA devices are available.

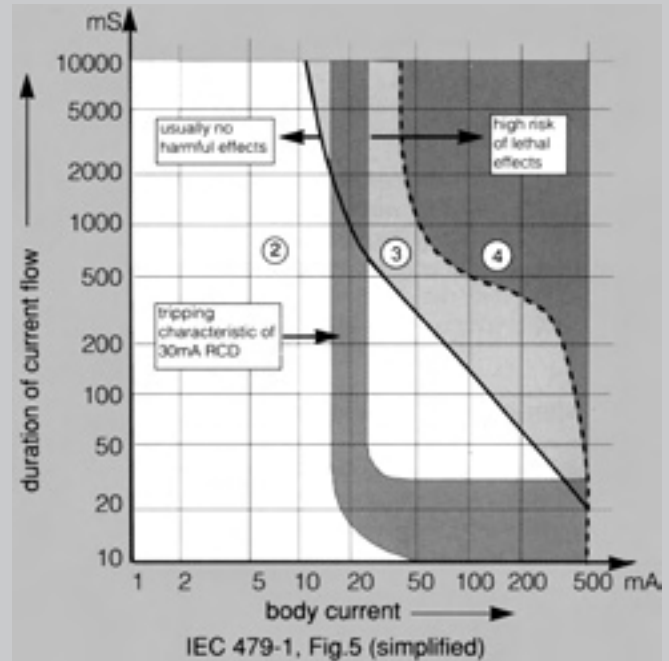

Fig 29

Note:
Although RCCBs are extremely effective devices they must never be used as the only method of protection against electric shock. With or without RCCB protection all electrical equipment should be kept in good condition and should never be worked on live.

Protection against shock outside the equipotential bonding zone

Bonding conductors are used in an installation to maintain metallic parts, as near as possible, to the same potential as earth. Working with portable equipment outside this equipotential bonding zone, e.g. in the car park of a factory, introduces additional shock hazards. Socket outlets rated 32A or less 'which may be reasonably expected to supply portable equipment for use outdoors' be equipped with 30mA RCCB protection unless fed from an isolating transformer or similar device, or fed from a reduced voltage.

Protection in special locations

The use of RCCBs is obligatory or recommended in the following situations:

- Caravans: 30mA RCCBs should be used.
- TT systems.
- Swimming pools: 30mA RCCB for socket outlets in Zone B obligatory; recommended in Zone C.
- Agricultural and horticultural: 30mA RCCB for socket outlets and for the purpose of protection against fire, $RCCB \leq 0.5A$ sensitivity.
- Construction sites: 30mA RCCB recommended.

Portable equipment

With the exception mentioned above, where a socket is specifically designated for work outside the equipotential bonding zone, the Wiring Regulations demand the use of RCCBs to protect the users of portable equipment. It is widely recognised that their use has made a significant contribution to safety in the workplace and the home.

Protection against fire hazards

The provisions in the Wiring Regulations for protection against shock by indirect contact ensure rapid disconnection under earth fault assuming the fault has negligible impedance. Under such conditions the fault current, as we have seen, is sufficiently great to cause the overcurrent protection device to quickly disconnect the fault. However high impedance faults can arise where the fault current is sufficient to cause considerable local heat without being high enough to cause tripping of the overcurrent protective device. The heat generated at the point of the fault may initiate a fire long before the fault has deteriorated into a low impedance connection to earth.

The provision of residual current protection throughout a system or in vulnerable parts of a system will greatly reduce the hazard of fire caused by such faults.

PEN conductors

The use of RCCBs with PEN conductors is prohibited. A PEN conductor is a single conductor combining the functions of neutral conductor and protective conductor. This being so, when the PEN conductor is taken through the torroid of an RCCB, earth faults will go undetected because the return path for the earth fault current is included in the residual sum.

Auxiliary contacts

A range of auxiliaries, alarm and shunt contacts are available for Hager RCCBs.

Supply entry

Top or bottom feed.

CB/RCCB co-ordination

RCCB	Short circuit current capacity of the RCCB only	MTN 6-63A B	With MCB's		
			NBN	NCN	NDN
			6-63A B	6-63A C	6-63A D
2 poles					
16A	1500A	6kA	10kA	10kA	6kA
25A	1500A	6kA	10kA	10kA	6kA
40A	1500A	6kA	10kA	10kA	6kA
63A	1500A	6kA	10kA	10kA	6kA
80A	1500A	6kA	10kA	10kA	6kA
100A	1500A	6kA	10kA	10kA	6kA
4 poles					
16A	1500A	6kA	6kA	6kA	4.5kA
25A	1500A	6kA	6kA	6kA	4.5kA
40A	1500A	6kA	6kA	6kA	4.5kA
63A	1500A	6kA	6kA	6kA	4.5kA
80A	1500A	6kA	6kA	6kA	4.5kA
100A	1500A	6kA	6kA	6kA	4.5kA

Table 43

RCCB	Short circuit current capacity of the RCCB only	With BS 1361 fuses With BS 88 fuse					
		60A	80A	100A	60A	80A	100A
2P							
16A	1500A	13kA	6kA	3.5kA	11kA	5kA	3kA
25A	1500A	13kA	6kA	3.5kA	11kA	5kA	3kA
40A	1500A	13kA	6kA	3.5kA	11kA	5kA	3kA
63A	1500A	13kA	6kA	3.5kA	11kA	5kA	3kA
80A	1500A	13kA	6kA	3.5kA	11kA	5kA	3kA
100A	1500kA	13kA	6kA	3.5kA	11kA	5kA	5kA
4P							
16A	1500A	13kA	6kA	3.5kA	11kA	5kA	3kA
25A	1500A	13kA	6kA	3.5kA	11kA	5kA	3kA
40A	1500A	13kA	6kA	3.5kA	11kA	5kA	3kA
63A	1500A	13kA	6kA	3.5kA	11kA	5kA	3kA
80A	1500A	13kA	6kA	3.5kA	11kA	5kA	3kA
100A	1500A	13kA	6kA	3.5kA	11kA	5kA	3kA

Table 44

RCCB Add-Ons

3 sensitivities 30mA, 100mA & 300mA instantaneous.
 2 sensitivities 100mA & 300mA time delayed.
 RCCB add-ons can be associated with devices rated from 0.5 to 63A in 2 and 4 poles.

Connection capacity



63A = 16mm²



63A = 25mm²

Wiring Diagram

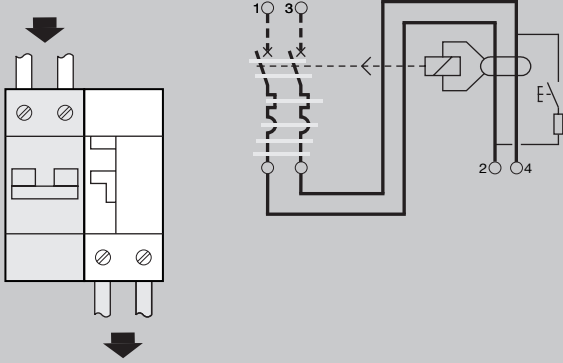

Characteristics

- Easy coupling (drawer system)
- Easy disassembly (without damage)
- Conforms to EN61009 Appendix G

Fig 30

MCB & RCCB add-on association chart

	2 Pole			4 Pole		
	In	≤63A			≤63A	
Sensitivity	30mA	100mA	300mA	30mA	100mA	300mA
Cat Ref. (standard)	BD264	BE264	BF264	BD464	BE464	BF464
Cat Ref. (time delayed)		BN264	BP264		BN464	BP464
MCB suitability						
NBN	6-63A	6-63A	6-63A	6-63A	6-63A	6-63A
NCN	0.5-63A	0.5-63A	0.5-63A	0.5-63A	0.5-63A	0.5-63A
NDN	0.5-63A	0.5-63A	0.5-63A	0.5-63A	0.5-63A	0.5-63A
Width when combined with MCB		4 module 70mm				7 module 122.5mm

Table 45

Mounting

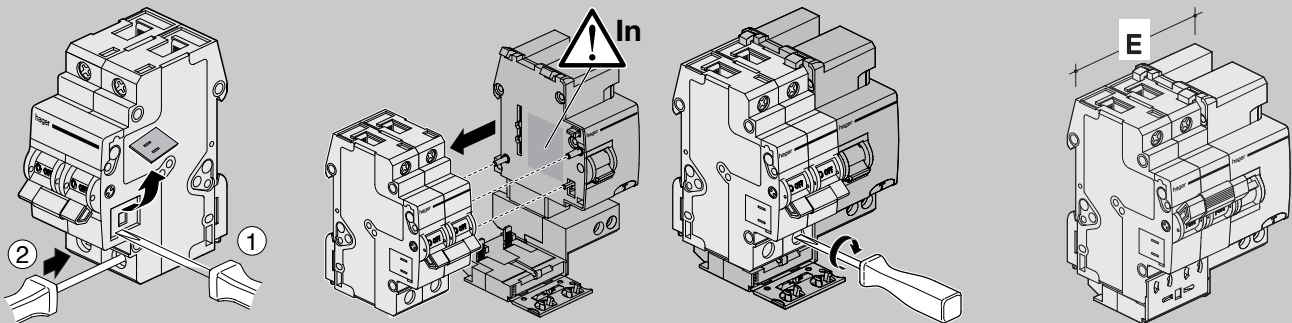

Fig 31

Technical specifications

	Non-Adjustable		Adjustable						
	HR400	HR402	HR403	HR410	HR411	HR420	HR425	HR440	HR441
Supply voltage ~50/60HZ	220-240V								
Residual voltage ~50/60Hz	500V Maximum								
Power Absorbed	3VA		5VA						
Output	Volt free contacts								
Contact Rating	6A / 250V AC-1								
Sensitivity I Δ n	0.03A / 0.1A / 0.3A / 1A / 3A / 10A							0.03A / 0.1A / 0.3A / 0.5A / 1A / 3A / 10A	
Instantaneous / Time Delay	Instantaneous			Instantaneous or time delay 0.13s / 0.3s / 1s / 3s			Instantaneous or time delay 0s / 0.1s / 0.3s / 0.45s / 0.5s		Instantaneous or time delay 0s / 0.1s / 0.3s / 0.5s / 0.75s / 1s
Torroid Withstand Capacity	50kA / 0.2s								
Distance between torroid and relay	50 Meter Maximum								
Relay cable connection	- Rigid 1.5□ to 10□ - Flexible 1□ to 6□								
Torroid cable connection	- Rigid 1.5□ to 4□ - Flexible 1□ to 2.5□								
Relay Working temperature	-10°C to +55°C		-5°C to +55°C						
Relay Storage temperature	-25°C to +40°C		-25°C to +40°C						
Torroid Working temperature	-10°C to +70°C		-10°C to +70°C						
Torroid Storage temperature	-40°C to +70°C		-40°C to +70°C						

Table 46

Main Characteristics

“Reset” Button

When pressed, the output remains switched and return to normal is obtained by either: by pressing the “reset” clear pushbutton or cutting off the power supply. If the “reset” button is not pressed the device remains in the fault position.

Test Button

Pressing the test button allows a fault simulation which operates the relay and the output contacts. The fault level display is shown by an LED on the front of the product.

I Δ n selector

Sensitivity setting: 0.03A instantaneous
0.1A/0.3A/1A and 3A time delay

Time delay selector

Adjustable time setting - instantaneous / 0.13s / 0.3s / 1s and 3s

Sealable settings

A sealable cover prevents interference once the settings have been made.

Standard output (1 C/O contact)

Switching to state 1 on:

- Failure of the core/relay connection
- Fault current in the monitored installation

Positive safety outlet (1 C/O contact)

Switching to state 1: Switching on the power

Switching to state 0: Failure of the core/relay connection
fault current in the monitored installation
failure of relay supply
internal failure of relay

Optical scale display by 5 LEDs of the fault in % of I Δ n

Optical scale display by (5 LEDs) of the fault in % of I Δ n

Common pin 6:

State 1 : output terminal 8

State 0 : output terminal 4

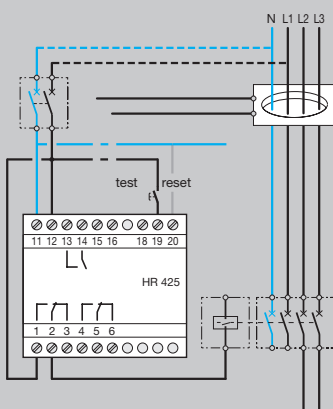

1. Reset push button
2. Test push button
3. Fault signal LED
4. Device on indicator
5. Sensitivity setting
6. Time delay setting
7. Standard output
8. Safety output
9. Prealarm output
10. Remote reset
11. Optical scale

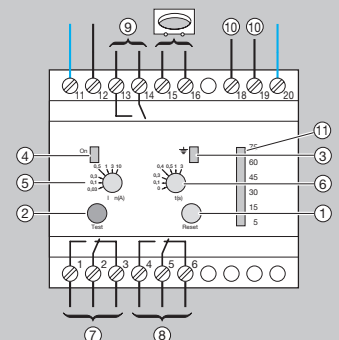

**Circular Torroids
HR800**

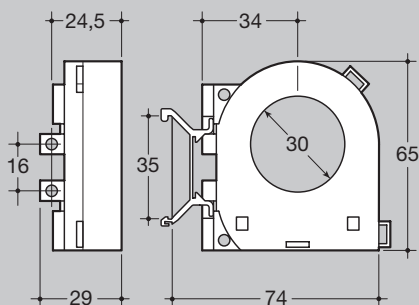

Circular Torroids

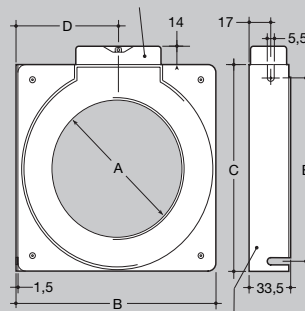

Fig 33

Reference	Type	Dimensions (mm)				
		A	B	C	D	E
HR801	Ø 35	35	92	86	43.5	74
HR802	Ø 70	70	115	118	60.5	97
HR803	Ø 105	105	158	162.5	84.5	140
HR804	Ø 140	140	218	200	103.5	183
HR805	Ø 210	210	290	295	150	265

Table 47

Rectangular Torroids

Reference	Type	Dimensions (mm)								
		A1	A2	B	C	D	E	F	G	H
HR830	70x175	70	175	176	260	85	225	22	40	7.5
HR831	115x305	115	305	239	400	116	360	25	50	8.5
HR832	150x350	150	350	284	460	140	415	28	50	8.5

Table 48

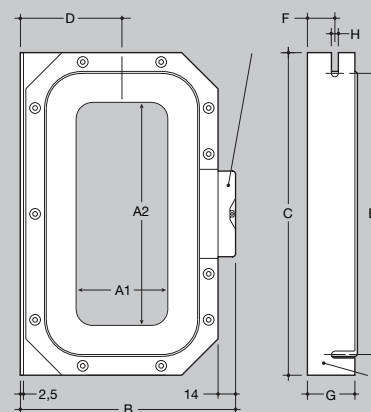
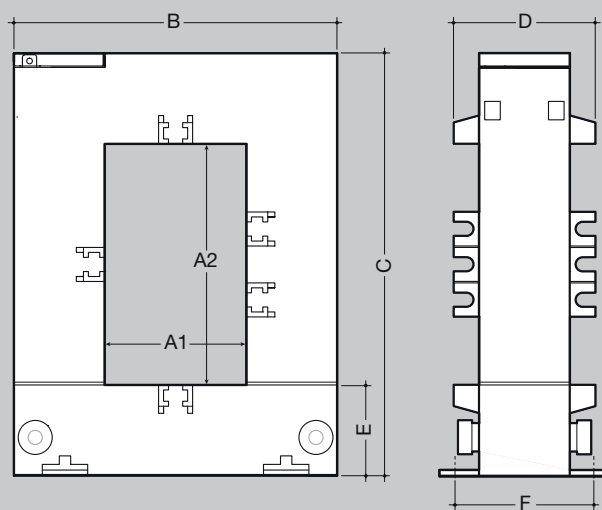

Fig 34

Rectangular Torroids

Reference	A1	A2	B	C	D	E	F
HR820	20	30	89	110	41	32	46
HR821	50	80	114	145	50	32	46
HR822	80	80	145	145	50	32	46
HR823	80	121	145	185	50	32	46
HR824	80	161	184	244	70	37	46



Mounting of Circular Torroids

With Cables ►

U 1000 R2V
Single pole



U 1000 R2V
Single pole



U 1000 R2V
Multi pole



U 1000 R2V
multi pole



U 1000 R2V
multi pole



H07 V - U
single pole



H07 V - U
single pole



Type of Torroid ▼
Ø

Type of Torroid	Ø	U 1000 R2V Single pole	U 1000 R2V Single pole	U 1000 R2V Multi pole	U 1000 R2V multi pole	U 1000 R2V multi pole	H07 V - U single pole	H07 V - U single pole
30	HR800	4 x 16□	2 x 50□	35□	35□	50□	4 x 35□	2 x 70□
35	HR801	4 x 25□	2 x 70□	50□	35□	70□	4 x 50□	2 x 95□
70	HR802	4 x 185□	2 x 400□ or 4 x 150□	240□	35□	300□	4 x 240□	2 x 400□ or 4 x 185□
105	HR803	4 x 500□	2 x 630□ or 4 x 185□	300□	35□	300□	4 x 400□	2 x 400□ or 4 x 240□
140	HR804	4 x 630□	2 x 630□ or 4 x 240□	300□	35□	300□	4 x 400□	2 x 400□ or 4 x 240□
210	HR805	4 x 630□	2 x 630□ or 4 x 240□	300□	35□	300□	4 x 400□	2 x 400□ or 4 x 240□
70 x 175	HR830	4 x 630□	2 x 630□ or 4 x 240□	300□	35□	300□	4 x 400□	2 x 400□ or 4 x 240□
115 x 305	HR831	4 x 630□	2 x 630□ or 4 x 240□	300□	35□	300□	4 x 400□	2 x 400□ or 4 x 240□
150 x 350	HR832	4 x 630□	2 x 630□ or 4 x 240□	300□	35□	300□	4 x 400□	2 x 400□ or 4 x 240□
20 x 30	HR820	4 x 16□	2 x 70□	10□	35□	16□	4 x 10□	2 x 35□
50 x 80	HR821	4 x 240□	2 x 630 or 4 x 185□	120□	35□	150□	4 x 185□	2 x 240□
80 x 80	HR822	4 x 500□	2 x 630 or 4 x 185□	300□	35□	300□	4 x 400□	2 x 400 or 4 x 240□
80 x 120	HR823	4 x 630□	2 x 630 or 4 x 240□	300□	35□	300□	4 x 400□	2 x 400 or 4 x 240□
80 x 160	HR824	4 x 630□	2 x 630 or 4 x 240□	300□	35□	300□	4 x 400□	2 x 400 or 4 x 240□

Typical RCCB Time/Current Characteristics

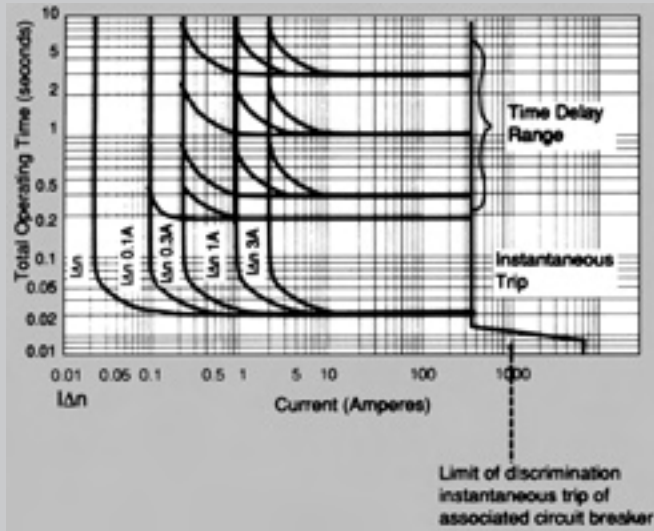

Fig 36

Discrimination between Circuit Breakers with add on RCCBs

Having decided on the type and the limit of discrimination of the circuit breakers in the system, it is very important to consider the discrimination between any add on RCCBs. In theory it is possible to achieve current discrimination between RCCBs but the limit of discrimination is too low for practical purposes. Time discrimination is by far the best method and is achieved by delaying the tripping of the upstream RCCB, See Fig 36, which shows the RCCB characteristics for both instantaneous and time delayed.

Note that the limit of discrimination is the instantaneous setting of the associated circuit breaker. In other words if the earth fault current is greater than the instantaneous trip setting of the associated circuit breaker, the circuit breaker will trip regardless of the time delay on the RCCB. Table 49 indicates how time discrimination may be achieved between RCCBs.

Discrimination between Residual Current Devices

		Up-stream residual current device																								
		Up-stream RCCB sensitivity IΔn	0.01A				0.03A				0.1A				0.3A				1.0A				3.0A			
Down-stream Residual Current Device	Downstream RCCB Sensitivity IΔn	Time Delay Secs	0	0	0	0.2	0	0.2	0.3	1.0	3.0	0	0.3	1.0	3.0	0	0.3	1.0	3.0	0	0.3	1.0	3.0			
	0.01A	0	0																							
0.03A		0																								
0.1A		0																								
		0.2																								
0.3A		0																								
		0.2																								
		0.3																								
		1.0																								
		3.0																								
1.0A		0																								
		0.3																								
		2.0																								
	3.0																									
3.0A	0																									
	0.3																									
	1.0																									
	3.0																									

Table 49

■ Discrimination achieved

	Class II - overvoltage protection					
	High	Medium				Fine
Reference	SPN140D	SPN215D	SPN215R	SPN415D	SPN415R	SPN208S
Installation exposure level (risk)	High	Medium	Medium	Medium	Medium	Low
Installation of SPD	Parallel	Parallel	Parallel	Parallel	Parallel	Series
Number of poles	1P	1P+N	1P+N	3P&N	3P&N	1P+N
Number of Modules	1	2	2	4	4	2
Nominal current	-	-	-	-	-	-
Nominal Voltage U_n (V)	230	230	230	400	400	230/400
Frequency (Hz)	50/60	50/60	50/60	50/60	50/60	50/60
Max. continuous operating Voltage U_c (V)						
common mode -	275	275	275	275	275	440
differential mode -						255
Voltage protection level U_p (kV)						
common mode -	1.2	1.0	1.0	1.0	1.0	1.2
differential mode -						1.0
Discharge current wave 8/20us (kA)						
Nominal current I_n	15	5	5	5	5	2
Maximum current I_{max}	40	15	15	15	15	8
Operating temperature range	-40/+60	-40/+60	-40/+60	-40/+60	-40/+60	-40/+60
Storage temperature range	-40/+70	-40/+70	-40/+70	-40/+70	-40/+70	-40/+70
Short circuit withstand with max. backup fuse or MCB	20kA	10kA	10kA	10kA	10kA	6kA
Max. backup fuse	25A	10A	10A	10A	10A	25A
Backup MCB (C curve)	25A	25A	25A	25A	25A	25A
End of life indication (fault indication)						
1. three stage indication-green, green/red, red (R versions)	Yes	N/A	Yes	N/A	Yes	N/A
2. Basic indication - green/red (D versions)	N/A	Yes	N/A	Yes	N/A	N/A
3. Green LED is on when SPD is working	N/A	N/A	N/A	N/A	N/A	Yes
Applications						
industrial & commercial buildings	Yes	Yes	Yes	Yes	Yes	Yes
domestic buildings	Yes	Yes	Yes	Yes	Yes	Yes
Connection capacity	2.5/35 mm ²	2.5/25 mm ²	2.5/25 mm ²	2.5/25 mm ²	2.5/25 mm ²	2.5/10 mm ²
Connection capacity for the auxiliary contact	N/A	N/A	0.5/1.5 mm ²	N/A	0.5/1.5 mm ²	N/A
Auxiliary contact	N/A	N/A	230V/0.5A	N/A	230V/0.5A	N/A
Voltage/nominal current			12Vdc 10mA		12Vdc 10mA	

Table 50

- I_{max} The maximum value of current that the SPD can withstand and remain operational.
- I_n The nominal value of current that the SPD can withstand at least 20 times and still be serviceable.
- U_p The residual voltage that is measured across the terminal of the SPD when I_n is applied.
- U_c The maximum voltage which may be continuously applied to the SPD without conducting.
- U_{oc} Open circuit voltage under test conditions.
- I_{sc} Short circuit current under test conditions.
- U_n The nominal rated voltage of the installation
- MOV Metal Oxide Varistor
- SPD Surge Protective Device.

How to choose your surge protection device

The choice of surge protection device depends on your supply arrangements and level of protection required

Earthing system	Type of protection	Connection	Products to be used in a Single phase installation	Three phase installation
TN-C TN-C-S (P-M-E)	Transient voltage surges (8/20ms)	Class II main protection $I_{max} = 40kA$ or $15kA$ (depending on selection)	Parallel 	
		Class II fine protection $U_p < 1kV$	Parallel 	
TN-S TT	Transient voltage surges (8/20ms)	Class II main protection $I_{max} = 15kA$ $I_{max} = 15kA$	Parallel 	
		Class II fine protection $U_p < 1kV$	Parallel 	

Connections

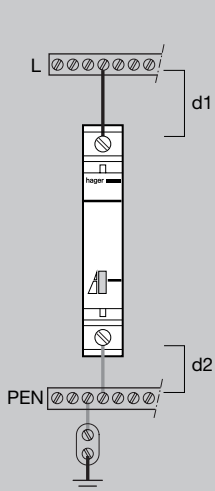

SPN140D

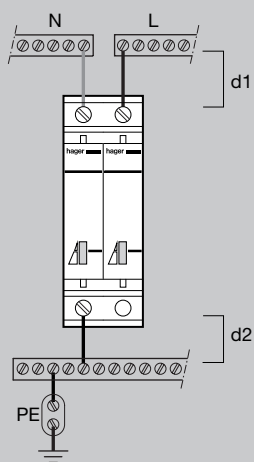

SPN215D/R

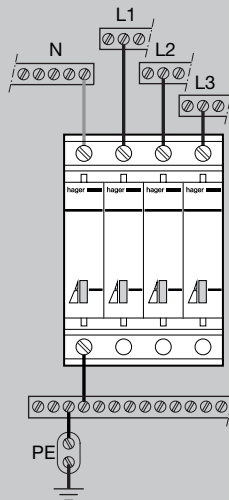

SPN415D/R

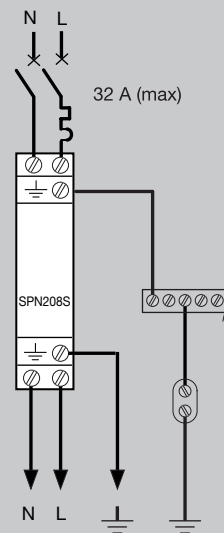

SPN208S

Fig 43

Technical Specifications

Electrical Characteristics

- Electrical supply: 230V/400V~
- Ambient temperature range: -25°C to +55°C
- Working life: 100,000 operations AC-3
- Maximum of 40 operations/hour
- Tropicalized for all climates
- Connection with clamp type, terminals connection capacity:
Flexible : 1 to 4N
Rigid : 1.5 to 6N

Electrical Connection Single Phase

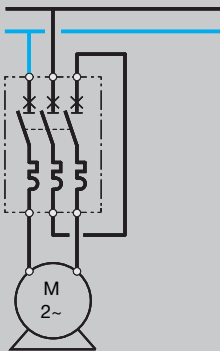

Fig 41

Time / Current Characteristics

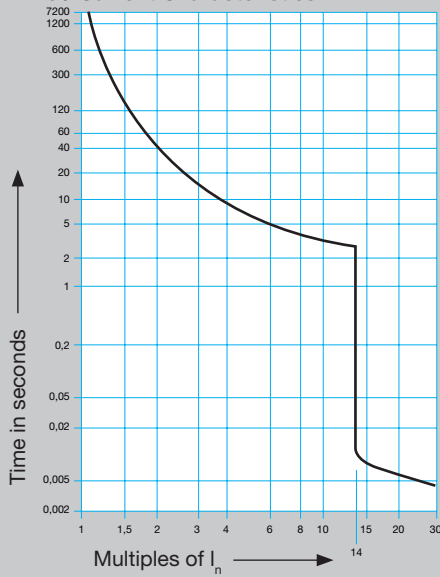

Fig 42

	230V	400V	230V / 400V a Mgl
MM 501N	100kA	100kA	100kA
MM 502N			
MM 503N			
MM 504N			
MM 505N			
MM 506N			
MM 507N			
MM 508N			
MM 509N			
MM 510N			
MM 511N	16kA	16kA	50kA
MM 512N			
MM 513N			

Table 52

Nominal breaking capacity \geq short circuit current: fuses are not necessary, if nominal breaking capacity $<$ short circuit current: fuses must be used, breaking capacity of association is 80kA (with BS 88 fuses).

Under voltage release (no volt coil)

- MZ528** 230V~
- MZ529** 400V~

Auxiliary contacts (Mounted inside starter)

- MZ520**
- 2A – 400V~
- 3.5A – 230V~

Alarm contact (Mounted under starter)

- MZ527**
- 2A – 400V~
- 1A – 230V~

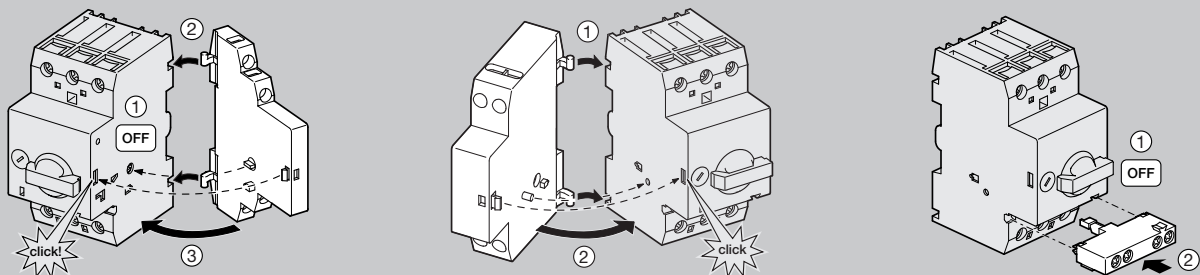

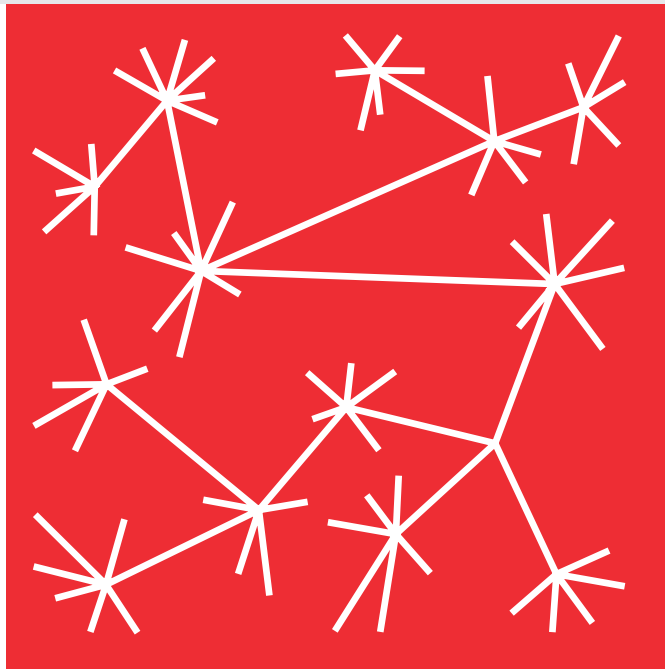

Modular Devices -
Indicators and Push Buttons

The new range of indicator lights and push buttons replaces and expands upon the whole SV range and is composed of the following three families

- Indicator Lights in various colours such as red, green, orange, blue and clear.
- Push Buttons in various contact types (NO, NC, NO+NC in 1 or 2 poles) and buttons (latching or impulse).
- Indicator Lights and Push Buttons, an association of the above two solutions.

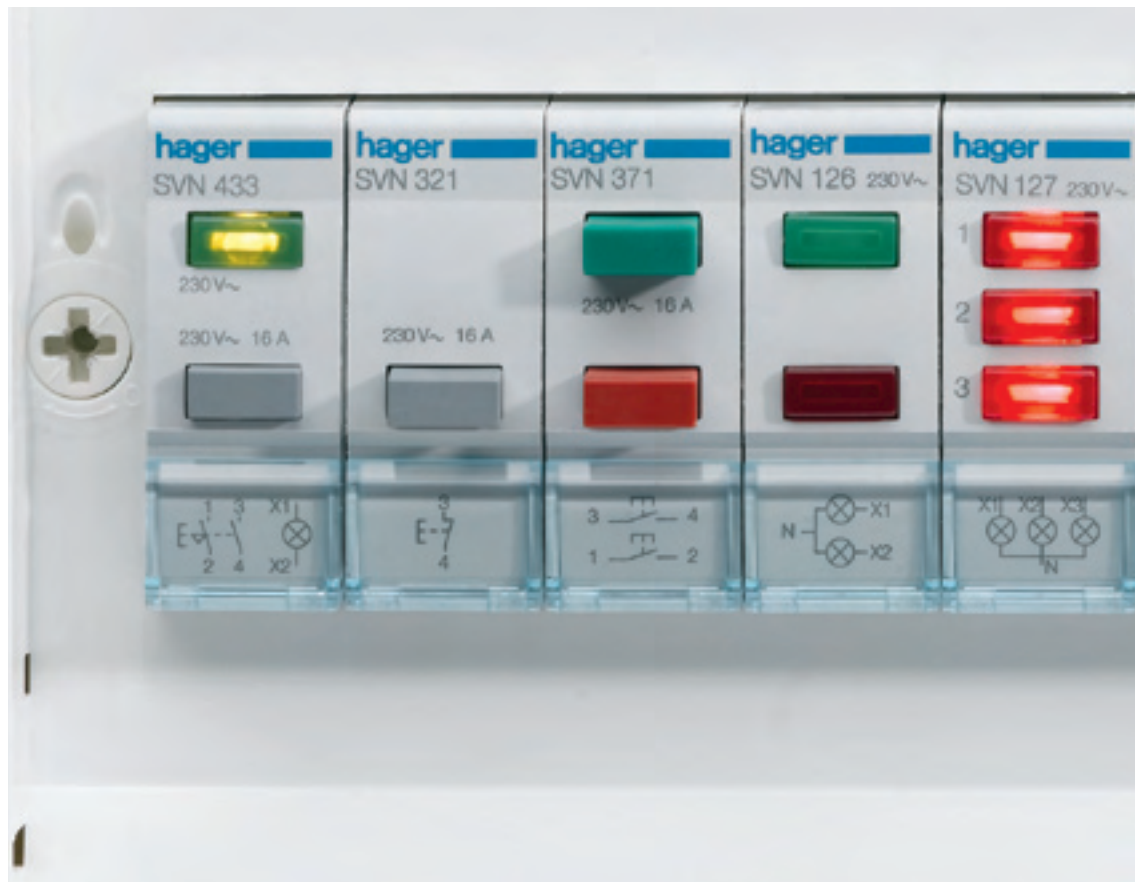

New LED technology provides longer life.



Updated and modernised appearance.



Integrated label holder.