

Connector - QPD P 3PE2,5 6-10 BK BK - 1582637

Please be informed that the data shown in this PDF Document is generated from our Online Catalog. Please find the complete data in the user's documentation. Our General Terms of Use for Downloads are valid (<http://phoenixcontact.com/download>)



Connector, QUICKON connection, number of positions: 3+PE, 1 mm² ... 2.5 mm², 690 V, 20 A, black, cable diameter range: 6 mm ... 10 mm

Your advantages

- ✔ Innovative and time saving - QUICKON fast connection for time saving of up to 80 % for on-site connection
- ✔ Convenient: quick and easy assembly without special tools
- ✔ Robust throughout: housing with IP68/IP69K and IK07 protection for a wide range of applications
- ✔ Safer connection thanks to polarization against mismatching and touch-proof protection according to DIN EN 0105
- ✔ Easy maintenance - the connectors enable fast device replacement and simplify startup thanks to pre-assembled cables

Key Commercial Data

Packing unit	1 pc
GTIN	 4 046356 618038
GTIN	4046356618038
Weight per Piece (excluding packing)	38.220 g
Custom tariff number	85366990
Country of origin	Germany
Note	Made to Order (non-returnable)

Technical data

General

Type	QPD 3PEx2,5
Color	black
Locking type	Screw locking
Connection method	QUICKON connection
	IDC connection
Number of positions	4
Note number of positions	3+PE

Connector - QPD P 3PE2,5 6-10 BK BK - 1582637

Technical data

General

Wrench size, union nut	22 mm
Tightening torque, union nut	5 Nm
Number of connections	4
Conductor cross section flexible min.	1 mm ²
Conductor cross section flexible max.	2.5 mm ²
Conductor cross section solid min.	1 mm ²
Conductor cross section solid max.	2.5 mm ²
Conductor cross section AWG min.	16
Conductor cross section AWG max.	14

Cabel

Structure of individual litz in acc. with VDE 0295 / smallest wire diameter	VDE 0295 class 1 to 6/min. 0.15 mm
Wire insulation material	PVC/PE/TPE/rubber
Wire diameter including insulation	2 mm ... 3.8 mm
External cable diameter	6 mm ... 10 mm
Position marking	1, 2, 3, PE

Ambient conditions

Degree of protection	IP66
	IP68 (2 m / 24 h)
	IP69K
Ambient temperature (operation)	-40 °C ... 100 °C
Ambient temperature (storage/transport)	-40 °C ... 80 °C
Temperature when conductor connected	-5 °C ... 50 °C

Electrical characteristics

Nominal current I _N	20 A
Rated current	20 A
Rated voltage (III/3)	690 V
Rated voltage (III/2)	1000 V
Rated voltage (II/2)	1000 V
Rated surge voltage (III/3)	6 kV
Rated surge voltage (III/2)	8 kV
Rated surge voltage (II/2)	8 kV

Mechanical characteristics

QUICKON connectability	max. 10
Insertion/withdrawal cycles	50
Category of shock impact	IK07

Material data

Contact material	Cu
Contact surface material	silver-plated

Connector - QPD P 3PE2,5 6-10 BK BK - 1582637

Technical data

Material data

Contact carrier material	PA
Insulating material	PA
Flammability rating according to UL 94	V0
Overvoltage category	III
Degree of pollution	3

Standards and Regulations

Flammability rating according to UL 94	V0
--	----

Environmental Product Compliance

China RoHS	Environmentally friendly use period: unlimited = EFUP-e
	No hazardous substances above threshold values

Drawings

Diagram

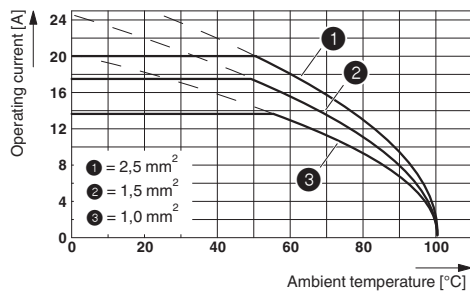

Dimensional drawing

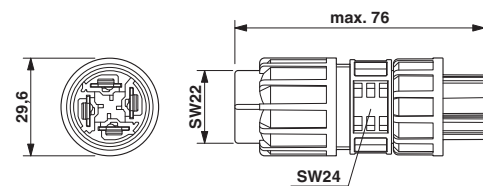

Dimensional drawing: connector, 2.5 mm²

Connector - QPD P 3PE2,5 6-10 BK BK - 1582637

Schematic diagram

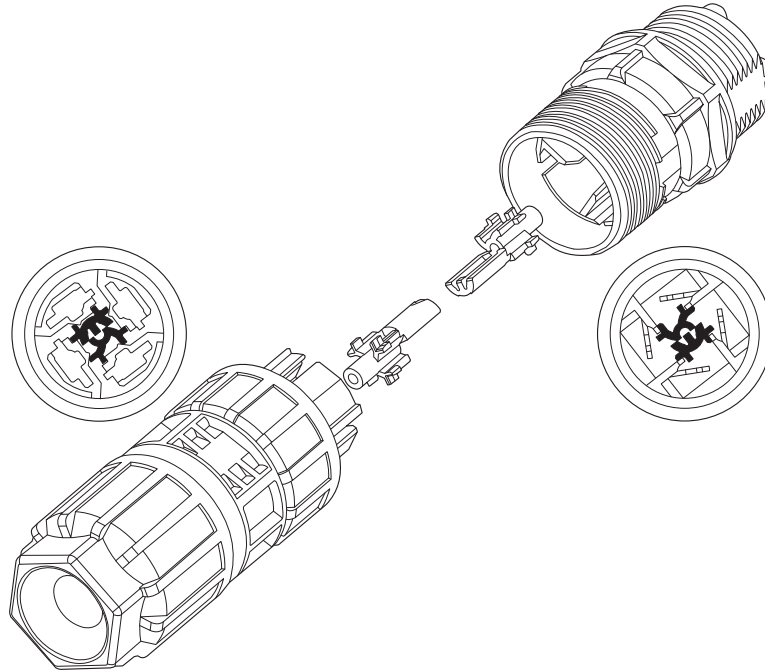

Coding of the QUICKON plug-in connection

Classifications

eCl@ss

eCl@ss 4.0	27140815
eCl@ss 4.1	27140815
eCl@ss 5.0	27143423
eCl@ss 5.1	27143400
eCl@ss 6.0	27143400
eCl@ss 7.0	27440605
eCl@ss 8.0	27440605
eCl@ss 9.0	27440602

ETIM

ETIM 4.0	EC002061
ETIM 5.0	EC002560
ETIM 6.0	EC002566

UNSPSC

UNSPSC 6.01	30211923
UNSPSC 7.0901	39121522
UNSPSC 11	39121522
UNSPSC 12.01	39121522
UNSPSC 13.2	39121522

Connector - QPD P 3PE2,5 6-10 BK BK - 1582637

Approvals

Approvals

Approvals

UL Listed / cUL Listed / GL / UL Listed / IECCEB Scheme / cUL Listed / VDE Zeichengenehmigung / EAC

Ex Approvals

Approval details

UL Listed		http://database.ul.com/cgi-bin/XYV/template/LISEXT/1FRAME/index.htm	FILE E 468743
Nominal voltage UN	600 V		
Nominal current IN	10 A		
mm ² /AWG/kcmil	16		

cUL Listed		http://database.ul.com/cgi-bin/XYV/template/LISEXT/1FRAME/index.htm	FILE E 468743
Nominal voltage UN	600 V		
Nominal current IN	10 A		
mm ² /AWG/kcmil	16		

GL		http://exchange.dnv.com/tari/	6195914 HH
----	---	---	------------

UL Listed		http://database.ul.com/cgi-bin/XYV/template/LISEXT/1FRAME/index.htm	FILE E 221474
Nominal voltage UN	600 V		
Nominal current IN	15 A		
mm ² /AWG/kcmil	14		

IECEE CB Scheme		http://www.iecee.org/	DE1-58228
-----------------	---	---	-----------

Connector - QPD P 3PE2,5 6-10 BK BK - 1582637

Approvals

cUL Listed		http://database.ul.com/cgi-bin/XYV/template/LISEXT/1FRAME/index.htm	FILE E 221474
Nominal voltage UN		600 V	
Nominal current IN		15 A	
mm ² /AWG/kcmil		14	

VDE Zeichengenehmigung		http://www2.vde.com/de/Institut/Online-Service/VDE-gepruefteProdukte/Seiten/Online-Suche.aspx	40029149
Nominal voltage UN		690 V	
Nominal current IN		20 A	
mm ² /AWG/kcmil		1.5-2.5	

EAC		RU C- DE.AI30.B.01102
-----	--	--------------------------

Accessories

Accessories

Coding element

Coding profile - CP-QPD - 1582459



Coding profile red, for pushing into the QUICKON dome and connector, can be positioned in 90° steps.

Device marking

Plastic label - EMLP (13X9)R - 0819453



Plastic label, Roll, white, unlabeled, can be labeled with: THERMOMARK ROLLMASTER 300/600, THERMOMARK X1.2, THERMOMARK ROLL X1, THERMOMARK ROLL 2.0, THERMOMARK ROLL, mounting type: adhesive, lettering field size: 13 x 9 mm

Connector - QPD P 3PE2,5 6-10 BK BK - 1582637

Accessories

Engraving material - GPE 13X 9 WH - 0806932



Engraving material, Sheet, white, unlabeled, can be labeled with: PLOTMARK, ENGRAVING UNIT, CMS-P1-PLOTTER, P1 ENGRAVING UNIT, mounting type: adhesive, lettering field size: 13 x 9 mm

Protective cap

Protective cap - QPD PSK 2,5 - 1582151



Protective cap made of transparent plastic for QPD connectors 4x 2.5 mm², IP50.

Seal

Seal - KV-DI-PG16-1XASI - 1582462



Seal for one AS-i line, 17.2 x 9 mm, from NBR, black, for IP65/67 degree of protection

Seal - KV-DI-PG16-2XASI - 1582464



Seal for two AS-i lines, 17.2 x 9 mm, from NBR, black, for IP65/67 degree of protection

Socket spanner

Socket wrench - QSS 22 - 1670206



Allen wrench, for loosening and fastening the QUICKON union nut, WAF 22 mm

