

# E Series Sealed Miniature Toggle Switches

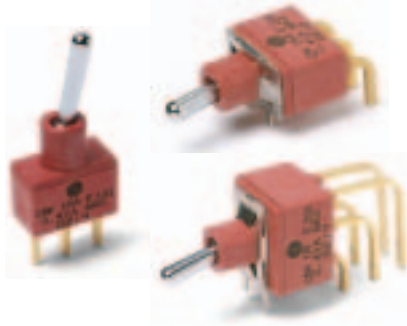

## Features/Benefits

- Sealed against solder and cleaning process contaminants
- UL 94V-0 Nylon case and bushing
- Multi-positions
- ESD protection available
- RoHS compliant models available

## Typical Applications

- Telecommunications
- Instrumentation
- Medical equipment



## Specifications

**CONTACT RATING:** B contact material: 0.4 VA max. @ 20 V AC or DC max. Q contact material: E1XX & E2XX  
**MODELS:** 7.5 AMPS @ 125 V AC or 28 V DC; 3 AMPS @ 250 V AC. E3XX MODELS: 5 AMPS @ 125 V AC or 28 V DC; 2 AMPS @ 250 V AC. See page G-25 for additional ratings.

**ELECTRICAL LIFE:** E1XX and E2XX models: 40,000 make-and-break cycles at full load. E3XX models: 30,000 cycles.

**CONTACT RESISTANCE:** Below 10 mΩ typ. initial @ 2-4 V DC, 100 mA, for both silver and gold plated contacts.

**INSULATION RESISTANCE:** 10<sup>9</sup> Ω min.

**ELECTROSTATIC DISCHARGE (ESD) OPTION:** F1 conductive bushing only. Dissipates up to 20,000 V DC from actuator to ground.

**DIELECTRIC STRENGTH:** 1000 Vrms min. @ sea level.

**OPERATING TEMPERATURE:** -30°C to 85°C.

**SOLDERABILITY:** Per MIL-STD-202F method 208D, or EIA RS-186E method 9 (1 hour steam aging).

**DEGREE OF PROTECTION:** IP57; Protection against harmful dust deposit, full-scale voltage protection, temporary immersion.

## Materials

**CASE & BUSHING:** Glass filled nylon 6/6, flame retardant, heat stabilized (UL 94V-0). F1 conductive bushing option is impregnated with carbon fibers.

**ACTUATOR:** Brass, chrome plated with internal o-ring seal standard.

**SWITCH SUPPORT:** Brass or steel, matte-tin plated.

**SWITCH SUPPORT RETAINER:** Stainless steel.

**CONTACTS & TERMINALS:** B contact material: Copper alloy, with gold plate over nickel plate. Q contact material: Copper alloy, silver plated. See page G-29 for additional contact materials.

**TERMINAL SEAL:** Epoxy.

**HARDWARE:** Nut & Locking ring: Brass, nickel plated.  
 Lockwasher: Steel, nickel plated.

**NOTE:** Any models supplied with P, S, R, Q, B or G contact material are RoHS compliant and compatible.

**NOTE:** Specifications and materials listed above are for switches with standard options. For information on specific and custom switches, consult Customer Service Center.

## Build-A-Switch

To order, simply select desired option from each category and place in the appropriate box. Available options are shown and described on pages G-23 thru G-29. For additional options not shown in catalog, consult our Customer Service Center. All models are process sealed to withstand machine soldering temperatures and pressure wash cleaning methods.

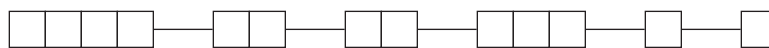

### Switch Function

- E101** SP, On-None-On
- E103** SP, On-Off-On
- E105** SP, Mom.-Off-Mom.
- E107** SP, On-Off-Mom.
- E108** SP, On-None-Mom.
- E201** DP, On-None-On
- E203** DP, On-Off-On
- E205** DP, Mom.-Off-Mom.
- E207** DP, On-Off-Mom.
- E208** DP, On-None-Mom.
- E211** DP, On-On-On
- E213** DP, On-On-Mom.
- E215** DP, Mom.-On-Mom.
- E301** 3P, On-None-On

### Actuator

- M** .300" high
- S** .500" high
- L3** Plastic, .940" high

### Bushing

- D1** .250" high
- F1** Conductive, .250" high\*
- D9** .280" high
- Y** Threaded, .350" high

### Terminations

- A** Right angle, PC thru-hole
- AV2** Vertical right angle, PC thru-hole
- C** PC Thru-hole
- V3** .460" high, V-bracket
- Z** Solder lug
- A3** Right angle, PC thru-hole
- AV3** Vertical right angle, PC thru-hole
- V6** .460" high, V-bracket
- V9** 1.150" high, V-bracket
- V31** .460" high, snap-in V-bracket
- V61** .460" high, snap-in V-bracket
- W** .750" long, wire wrap
- Z3** Quick connect

### Contact Material

- B** Gold
- P** Gold, matte-tin
- Q** Silver
- S** Silver, matte-tin
- G** Gold over silver
- R** Gold over silver, matte-tin

### Seal

- E** Epoxy

\* F1 available with SP and DP versions only, please see page G-24



Toggle



Dimensions are shown: Inch (mm)  
 Specifications and dimensions subject to change

# E Series Sealed Miniature Toggle Switches

## SWITCH FUNCTION

NO. POLES	MODEL NO.	SWITCH FUNCTION			CONNECTED TERMINALS			SCHEMATIC
		POS. 1 	POS. 2 	POS. 3 	POS. 1 	POS. 2 	POS. 3 	
SP	E101	ON	NONE	ON	2-3	N/A	2-1	
	E103	ON	OFF	ON	2-3	OPEN	2-1	
	E105	MOM.	OFF	MOM.				
	E107	ON	OFF	MOM.				
	E108	ON	NONE	MOM.				
<b>SPDT</b>								
Part number shown: E101SD1CBE								
DP	E201	ON	NONE	ON	2-3,5-6	N/A	2-1,5-4	
	E203	ON	OFF	ON	2-3,5-6	OPEN	2-1,5-4	
	E205	MOM.	OFF	MOM.				
	E207	ON	OFF	MOM.				
	E208	ON	NONE	MOM.				
	E211 **	ON	ON	ON	2-3,5-6	N/A	2-1,5-4	
	E213**	ON	ON	MOM.	2-3,5-6	2-3,5-4	2-1,5-4	
	E215**	MOM.	ON	MOM.	2-3,5-6	2-3,5-4	2-1,5-4	
<b>DPDT</b>								
Part number shown: E201SD1CBE								

MOM. = Momentary

\*\* Wiring for 3-way switch, see Section O.

All models with all options when ordered with G, L, R, M, Q or S contact material except with F1 conductive bushing.



Dimensions are shown: Inch (mm)  
Specifications and dimensions subject to change



Toggle

# E Series Sealed Miniature Toggle Switches

## SWITCH FUNCTION

NO. POLES	MODEL NO.	SWITCH FUNCTION			CONNECTED TERMINALS			SCHEMATIC
		POS. 1	POS. 2	POS. 3	POS. 1	POS. 2	POS. 3	
3P	<b>E301</b>	ON	NONE	ON	2-3,5-6,8-9	N/A	2-1,5-4,8-7	

**3PDT**

Part number shown: E301SD1CBE

MOM. = Momentary

\*\* Wiring for 3-way switch, see Section O.

All models with all options when ordered with G, L, R, M, Q or S contact material except with F1 conductive bushing.

## ACTUATOR

**M** .300" HIGH

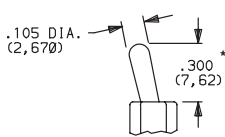

Standard when ordered with A, A3, AV2, AV3, V2-V61 terminations. Finish: Chrome.

**S** .500" HIGH

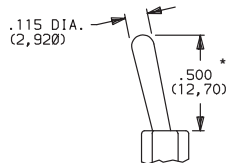

Standard when ordered with C, Z, Z3, W & W4 terminations. Finish: Chrome

**L3** PLASTIC, .940" HIGH

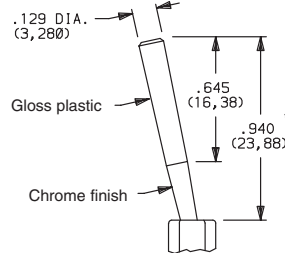

OPTION CODE	L3 ACTUATOR COLOR
<b>2</b>	BLACK

Other colors available, consult Customer Service Center. No color choice required for S & M actuators.

\* Actuators shown with standard D1 bushing. Subtract .030 (0,76) for D9 bushing. Subtract .100 (2,54) for Y bushing.

## BUSHING

**D1** .250" HIGH, UNTHREADED

**F1** ESD CONDUCTIVE BUSHING, .250" HIGH, UNTHREADED

F1 bushing is not UL/CSA approved

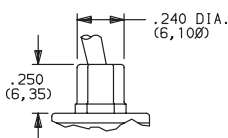
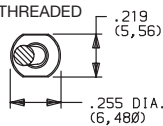

ESD protection depends on proper grounding of switch support bracket. F1 conductive bushing option is impregnated with carbon fibers; dissipates electrostatic discharge (ESD) up to 20,000 V from actuator to ground.

Available with SP and DP only with M & S actuator options and A, A3, AV2, AV3, V3-V61 termination options.

**D9** .280" HIGH, UNTHREADED

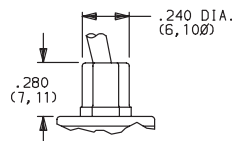
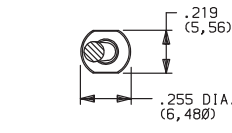

E3XX models not available with D9 bushing.

**NOTE:** Internal o-ring actuator seal standard for all bushing options.

**Y** THREADED, INSULATED, .350" HIGH WITH KEYWAY

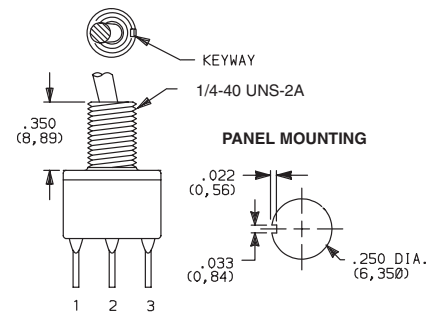

Available only with C, Z, Z3, & W terminations. Available for 1&2 pole only. Hardware: One dress nut part number 299D01201, one hex nut part number 540400201 and lockwasher part number 700303202 supplied standard. **Will withstand 4 in.-lbs. of torque with no distortion.**



Third Angle Projection  
Dimensions are shown: Inch (mm)  
Specifications and dimensions subject to change



**G**

Toggle

**C&K**

# E Series Sealed Miniature Toggle Switches

## TERMINATIONS

### Z SOLDER LUG

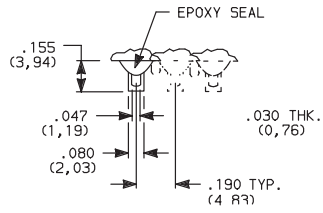

### SPDT thru 3PDT

Not available with F1 conductive bushing or P, R or S contact material.

### C PC THRU-HOLE

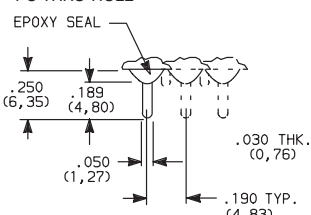

### SPDT thru 3PDT

Not available with F1 conductive bushing.

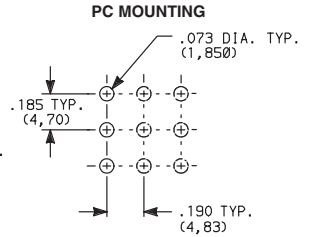

### Z3 QUICK CONNECT

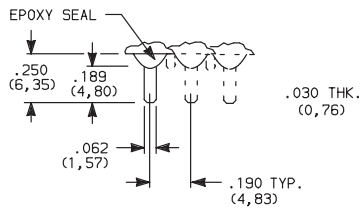

### SPDT thru 3PDT

Not available with F1 conductive bushing or P, R or S contact material. Mating quick connector available; order part number 530100000, page G-26.

### A RIGHT ANGLE, PC THRU-HOLE

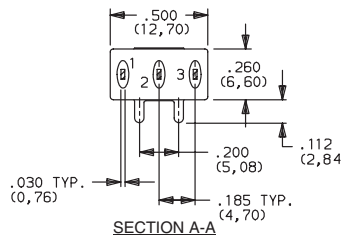
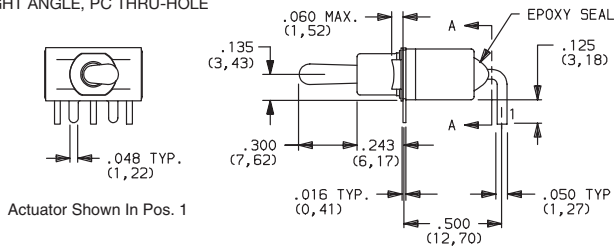

E101MD1ABE  
Horizontal Actuation  
SPDT

### A3 RIGHT ANGLE, SNAP-IN, PC THRU-HOLE

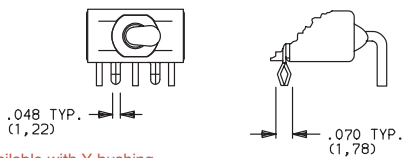

Not available with Y bushing.  
Terminal bend radii and lead-in manufacturing option.

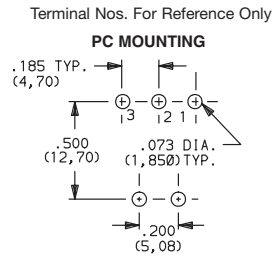

### A RIGHT ANGLE, PC THRU-HOLE

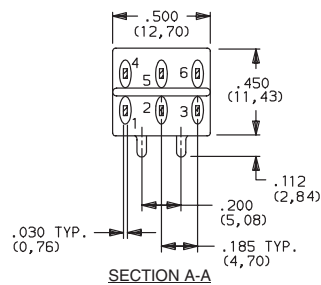
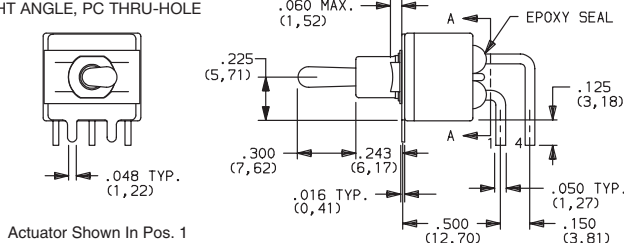

E201MD1ABE  
Horizontal Actuation  
DPDT

### A3 RIGHT ANGLE, SNAP-IN, PC THRU-HOLE

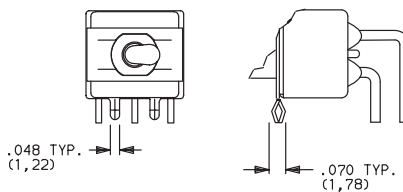

Not available with Y bushing.  
Terminal bend radii and lead-in manufacturing option.

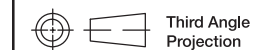
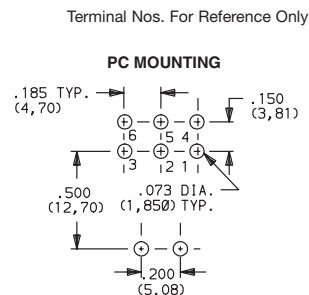

Third Angle Projection  
Dimensions are shown: Inch (mm)  
Specifications and dimensions subject to change



G

Toggle

# E Series Sealed Miniature Toggle Switches

## TERMINATIONS

### A RIGHT ANGLE, PC THRU-HOLE



**E301MD1ABE**  
Horizontal Actuation  
**3PDT**

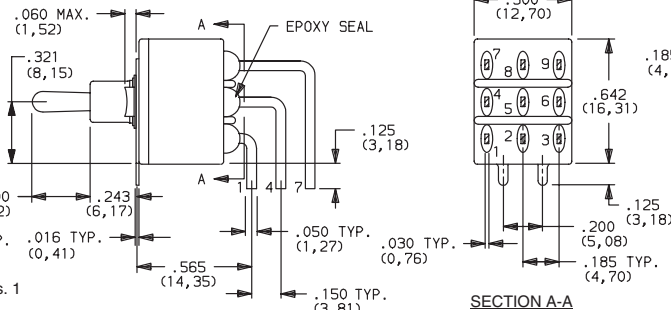
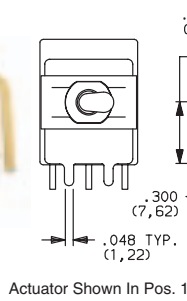

#### PC MOUNTING

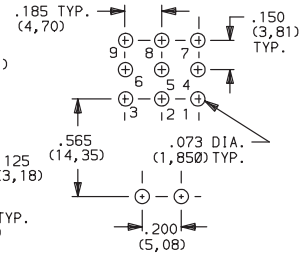

Terminal Nos. For Reference Only

Not available with D9 & Y bushings.  
Terminal bend radii and lead-in manufacturing option.

### AV2 VERTICAL RIGHT ANGLE, PC THRU-HOLE, .150" PITCH

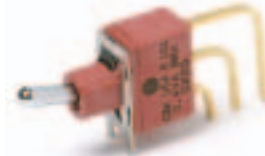

**E101MD1AV2BE**  
Vertical Actuation  
**SPDT**

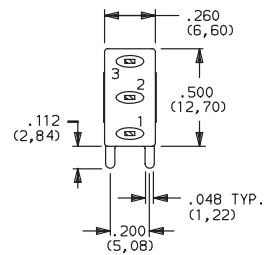
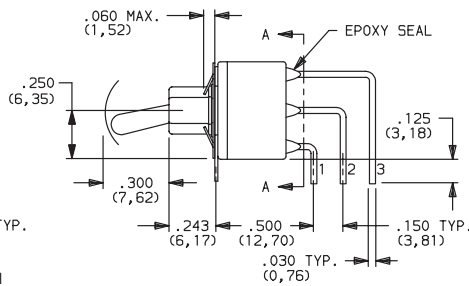
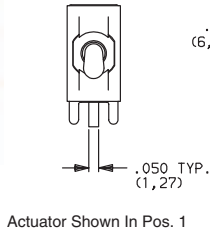

#### PC MOUNTING

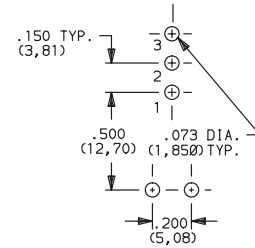

### AV3 VERTICAL RIGHT ANGLE, SNAP-IN, PC THRU-HOLE, .150" PITCH

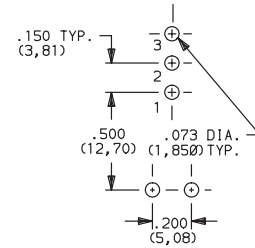
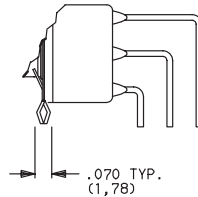
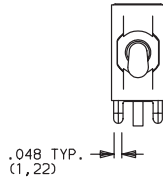

Not available with Y bushing.  
Terminal bend radii and lead-in manufacturing option.

### AV2 VERTICAL RIGHT ANGLE, PC THRU-HOLE, .150" PITCH



**E201MD1AV2BE**  
Vertical Actuation  
**DPDT**

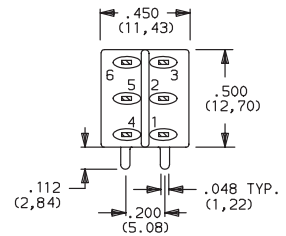
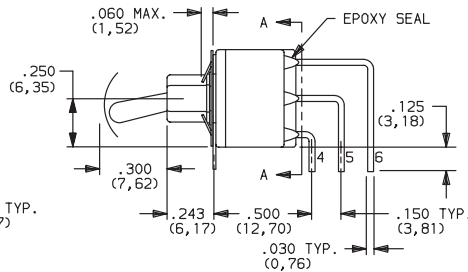
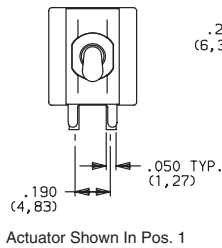

#### PC MOUNTING

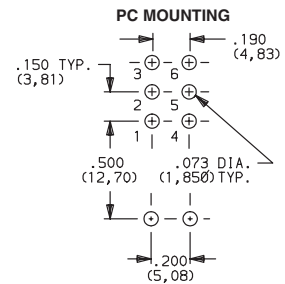

### A3 VERTICAL RIGHT ANGLE, SNAP-IN, PC THRU-HOLE, .150" PITCH

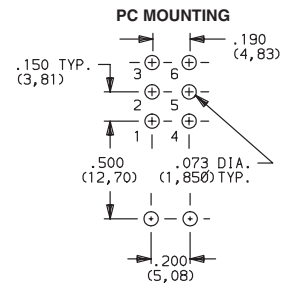
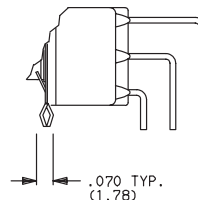
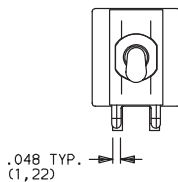

Not available with Y bushing.  
Terminal bend radii and lead-in manufacturing option.



Dimensions are shown: Inch (mm)  
Specifications and dimensions subject to change



# E Series Sealed Miniature Toggle Switches

## TERMINATIONS

**AV2** VERTICAL RIGHT ANGLE, PC THRU-HOLE,  
.150" PITCH

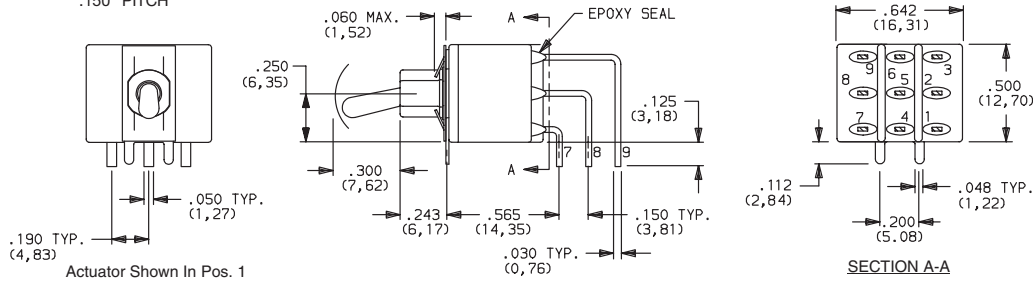

**E301MD1AV2BE**  
Vertical Actuation  
**3PDT**

**AV3** VERTICAL RIGHT ANGLE, SNAP-IN, PC THRU-HOLE  
.150" PITCH

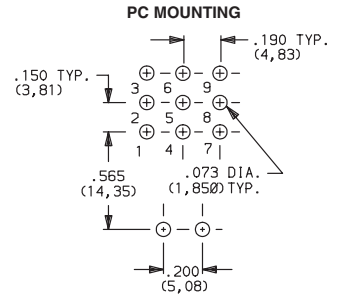

Not available with D9 & Y bushings.  
Terminal bend radii and lead-in manufacturing option.

**V6** VERTICAL MOUNT, V-BRACKET

**V61** VERTICAL MOUNT, V-BRACKET, SNAP-IN

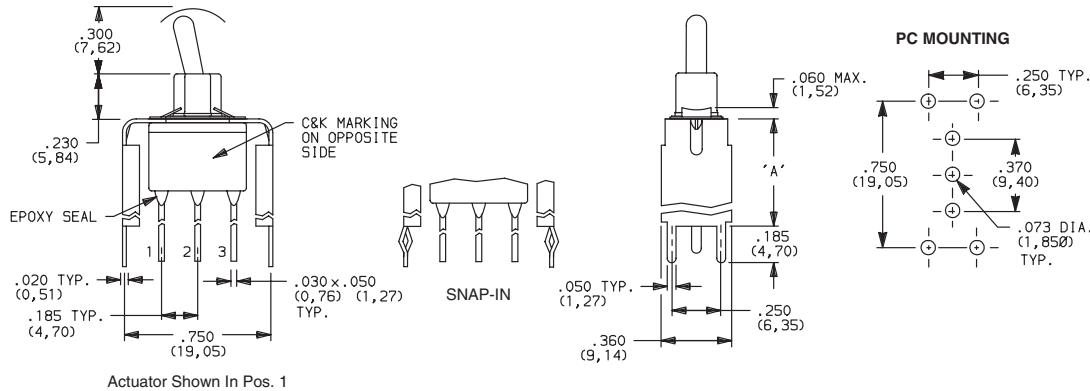

**E101MD1\_BE**  
**SPDT**

OPTION CODE	DIM 'A'
<b>V6, V61</b>	.460 (11,68)

Not available with Y bushing.

**V6** VERTICAL MOUNT, V-BRACKET

**V61** VERTICAL MOUNT, V-BRACKET, SNAP-IN

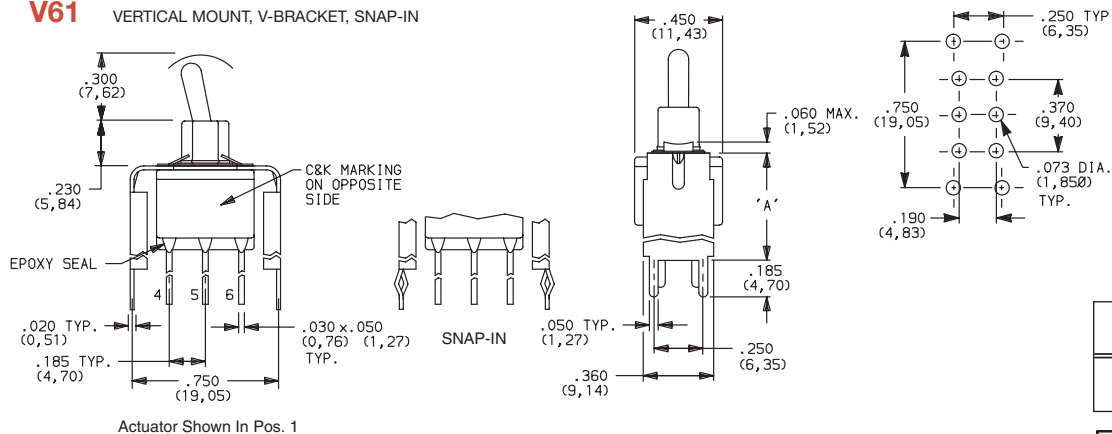

**E201MD1\_BE**  
**DPDT**

OPTION CODE	DIM 'A'
<b>V6, V61</b>	.460 (11,68)

Not available with Y bushing.



Third Angle Projection  
Dimensions are shown: Inch (mm)  
Specifications and dimensions subject to change



# E Series Sealed Miniature Toggle Switches

## TERMINATIONS

**V3, V9** VERTICAL MOUNT, V-BRACKET

**V31** VERTICAL MOUNT, V-BRACKET, SNAP-IN



**E101MD1\_BE**  
**SPDT**

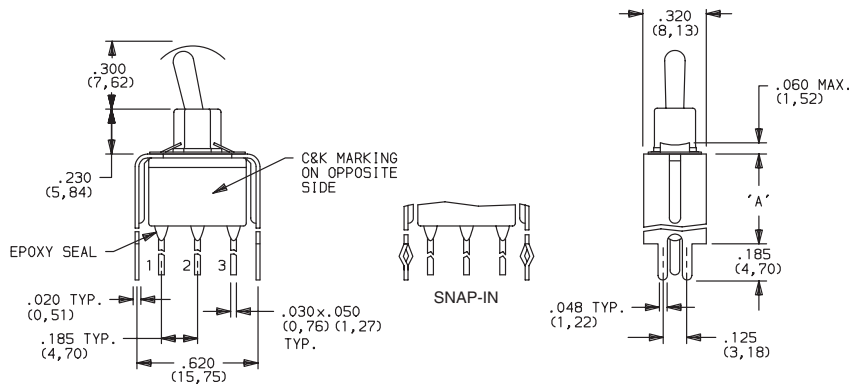

Actuator Shown In Pos. 1

**PC MOUNTING**

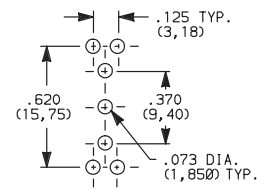

OPTION CODE	DIM 'A'
<b>V3, V31</b>	.460 (11,68)
<b>V9</b>	1.150 (29,21)

Not available with Y bushing.

**V3, V9** VERTICAL MOUNT, V-BRACKET

**V31** VERTICAL MOUNT, V-BRACKET, SNAP-IN



**E201MD1\_BE**  
**DPDT**

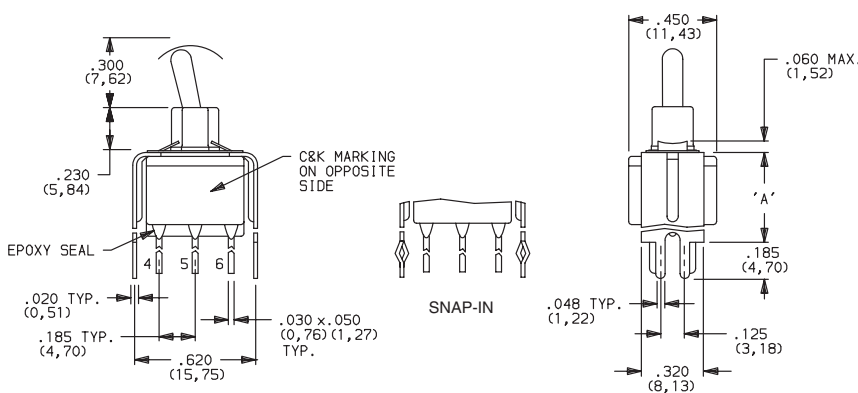

Actuator Shown In Pos. 1

**PC MOUNTING**

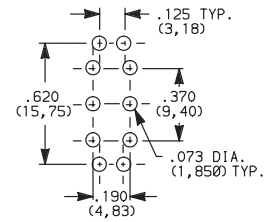

OPTION CODE	DIM 'A'
<b>V3, V31</b>	.460 (11,68)
<b>V9</b>	1.150 (29,21)

Not available with Y bushing.

**V9** VERTICAL MOUNT, V-BRACKET



**E301MD1\_BE**  
**3PDT**

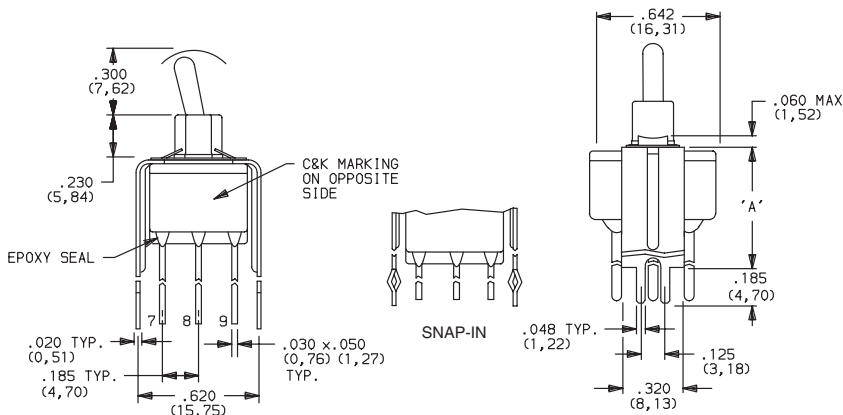

Actuator Shown In Pos. 1

**PC MOUNTING**

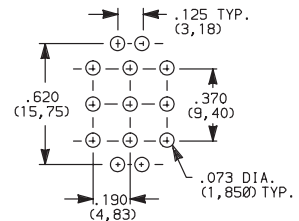

OPTION CODE	DIM 'A'
<b>V9</b>	1.150 (29,21)

Not available with D9 & Y bushings.



Toggle

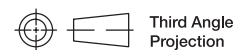

Third Angle Projection  
Dimensions are shown: Inch (mm)  
Specifications and dimensions subject to change

# E Series Sealed Miniature Toggle Switches

## CONTACT MATERIAL

OPTION CODE	CONTACT MATERIAL	TERMINAL PLATING	RATINGS	
<b>B</b>	GOLD <sup>1</sup>	GOLD <sup>1</sup>	LOW LEVEL/ DRY CIRCUIT	0.4 VA MAX. @ 20 V AC OR DC MAX.
<b>P</b>		MATTE-TIN <sup>6</sup>		
<b>Q</b>	SILVER <sup>4,5</sup>	SILVER <sup>5</sup>	POWER	E1XX & E2XX MODELS: 7.5 AMPS @ 125 V AC OR 28 V DC; 3 AMPS @ 250 V AC. E3XX MODELS: 5 AMPS @ 125 V AC OR 28 V DC; 2 AMPS @ 250 V AC.
<b>S</b>		MATTE-TIN <sup>6</sup>		
<b>G</b>	GOLD OVER SILVER <sup>2,3</sup>	GOLD <sup>3</sup>	LOW LEVEL/DRY CIRCUIT OR POWER	E1XX AND E2XX MODELS: 0.4 VA MAX @20 V AC OR DC MAX. OR 7.5 AMPS @125 V AC OR 28 V DC; 3 AMPS @ 250 V AC. DC E3XX MODELS: 0.4 VA MAX. @ 20 V AC OR DC MAX. OR 5 AMPS @ 125 V AC OR 28 V DC; 2 AMPS @ 250 V AC.
<b>R</b>		MATTE-TIN <sup>6</sup>		

\* Note: See Technical Data section of this catalog for RoHS compliant and compatible definitions and specifications.

<sup>1</sup> CONTACTS & TERMINALS: Copper alloy, with gold plate over nickel plate.

<sup>2</sup> END CONTACTS: Coin silver, with gold plate over nickel plate.



<sup>3</sup> CENTER CONTACTS & ALL TERMINALS: Copper alloy, with gold plate over nickel plate.

<sup>4</sup> END CONTACTS: Coin silver, silver plated.

<sup>5</sup> CENTER CONTACT & ALL TERMINALS: Copper alloy, with gold flash over silver plate. Or copper alloy, silver plated.

<sup>6</sup> TERMINALS: Copper alloy, with matte-tin over nickel plate.

**NOTE:** Any models supplied with P, S, R, Q, B or G contact material are RoHS compliant.

All models   with all options when ordered with S, R, G, L, M or Q contact material except with F1 conductive bushing.

B contact material standard with all terminations.

P, S & R contact materials not available with Z & Z3 terminations.

K, L and M options represent Non RoHS tin lead product and are not recommended for new designs. For additional information please contact Customer Service.

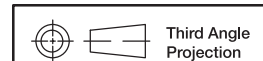

Third Angle  
Projection

Dimensions are shown: Inch (mm)

Specifications and dimensions subject to change

www.ck-components.com

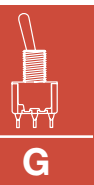

Toggle