



ENGLISH

## Datasheet

# AC Axial Fan, 120 x 120 x 38mm, 187m/h, 15W, 115 V ac (OA109 Series)

RS Stock number [619-6804](#)



### Frame and Impeller

PBT, UL94V-0 Thermoplastic

Finger Guard: G109-15A

Plastic Guard: G120P

Filter Kit: GRM120-30, GRM120-40

Aluminum Filter: WMG120M

RS Part Number	Speed (RPM)	Airflow (CFM)	Noise (db)	Volts (AC)	Voltage Range	Watts	Lead Type
6196775	3000	110	47	115	80~130	15	Terminal
6196781	3000	110	47	115	80~130	15	Terminal
6196804	3000	110	47	230	160~260	15	Terminal
6196826	3000	110	47	230	160~260	15	Terminal

\*20: Indicates Environmentally Protective Coating

Data Tolerance +/- 10%

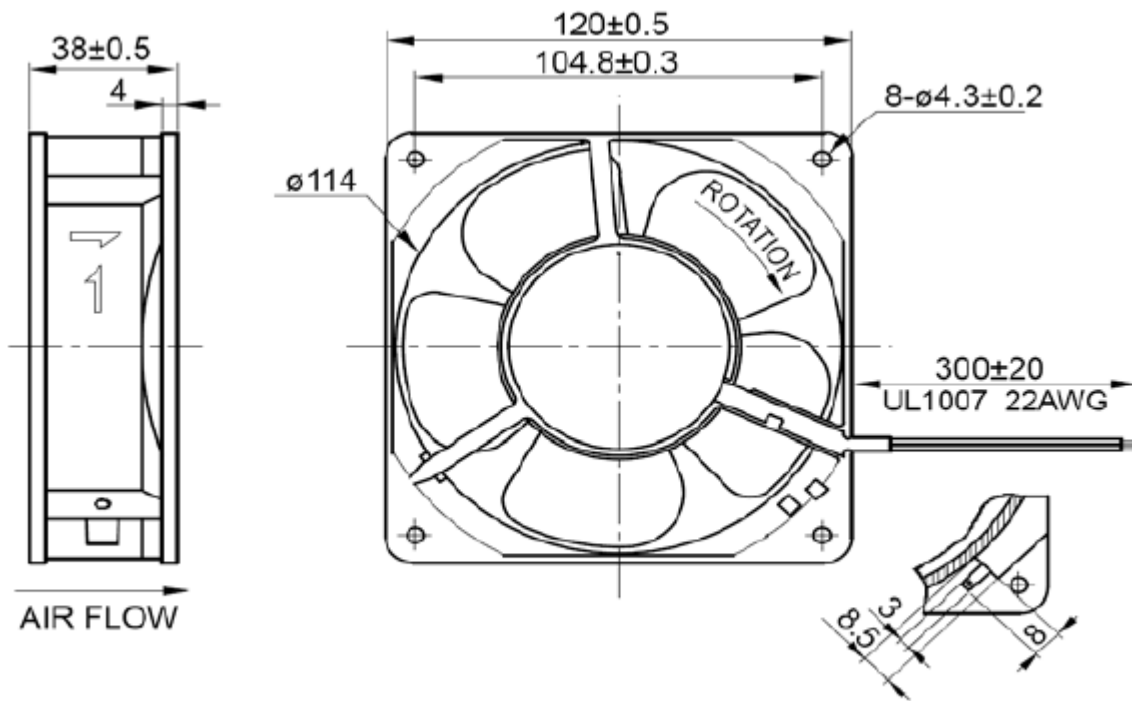
**Drawing(mm):**

\*Drawing for Dimensional Reference Only

**MOTOR**

Shaded Pole, Impedance Protected

**Dielectric Strength**

1 Minute at 1500 VAC, 50/60 Hz

**LIFE EXPECTANCY (L10)**

Ball Bearing 60,000 Hours

**Operating Temperature**

-20C ~ +80C

**Safety Approvals**

UL/CUL, TUV, CE