

PRODUCT SPECIFICATION

AMP* SUBMINIATURE COAXICON* CONTACTS

1.0 SCOPE

1.1 This specification contains performance requirements and qualification test procedures for subminiature COAXICON long, short, and Multi-Mate contacts.

2.0 APPLICABLE DOCUMENTS

2.1 The following specifications and standards form a part of this specification to the extent specified herein.

2.1.1 Military Specifications.

MIL-C-17	Coaxial Cable, Radio Frequency
MIL-C-50	Brass, Cartridge, Strip
MIL-C-14550	Copper Plating, Electrodeposited
MIL-G-45204	Gold Plating, Electrodeposited
MIL-T-10727	Tin Plating, Electrodeposited

2.1.2 Federal Specifications.

QQ-C-533	Copper, Beryllium Alloy Strip
ASTM-B-140	Bronze
L-P-394	General Purpose Polypropylene

2.1.3 Test Specifications.

MIL-C-45662	Calibration of Standards
MIL-STD-105	Sampling Procedures And Tables For Inspection By Attributes
MIL-STD-202	Test Methods For Electronic And Electrical Component Parts

3.0 REQUIREMENTS

3.1 Definitions. For the purpose of this specification, the following definitions shall apply.

* Trademark of AMP Incorporated

Copyright 1972 by AMP Incorporated. All International Rights Reserved. AMP Incorporated products covered by U.S. and Foreign Patents and or Patents Pending.

		OR <i>R. W. Prescott 7/27</i>		 AMP INCORPORATED Harrisburg, Pa.
		CHK <i>[Signature]</i>		
		APV <i>[Signature]</i>		LOC A
		DATE <i>8/1/76</i>		NO. 108-12011
B	ECN C77-112	<i>RD</i>	<i>PLC</i>	REV B
A	ECN C76-60	<i>AP</i>	<i>8/1/76</i>	
LTR	REVISION RECORD	DR	CHK DATE	
SHEET 1 OF 11			NAME SUBMINIATURE COAXICON CONTACTS	

- 3.1.1 Contact Assembly. Pin and socket contacts terminated to appropriate cable and inserted into connector housings.
- 3.1.2 Pin Contact. The contact which contains the female inner contact.
- 3.1.3 Socket Contact. The contact which contains the male inner contact.
- 3.1.4 Contact Shell. The shield or braid circuit of the contact.
- 3.2 Design and Construction. Contacts shall be of the design, construction and physical dimensions specified on the applicable AMP Product Drawing.
- 3.3 Materials and Finish. The materials utilized in the construction of the contacts and the finish or plating of the contacts shall be as specified on the applicable AMP Product Drawing.
- 3.4 Functional Characteristics.

TABLE I

Contact Operating Temperature	-65° to +105°C (to 125°C when tested on cable having polytetrafluoroethylene insulation)
Operating Voltage @ Sea Level	
Inner contact to shell	200 VRMS
Adjacent contact shell	1000 VRMS
Operating Voltage @ 70,000 feet	
Inner contact to shell	50 VRMS
Adjacent contact shell	150 VRMS
Current Rating Maximum	1 ampere

- 3.5 Performance. Contacts shall be designed to meet the performance requirements specified herein. To verify compliance to this specification, representative samples shall be subjected to the tests specified in Table III.

SHEET <u>2 OF 11</u>	 AMP INCORPORATED <i>Harrisburg, Pa.</i>		
LOC	A	NO.	108-12011
NAME		REV	B
SUBMINIATURE COAXICON CONTACTS			

3.5.1 Insulation Resistance. When tested as specified in Paragraph 4.6.2, the resistance between the inner contact and outer shell of a contact assembly shall be 5000 megohms minimum. The resistance between the outer shells of adjacent contacts, when tested in a connector housing, shall be 1000 megohms minimum.

3.5.2 Dielectric Withstanding Voltage. When tested as specified in Paragraph 4.6.3 while at sea level, a contact assembly shall withstand a test potential of 600 VRMS between the inner contact and outer shell. A test potential of 1000 VRMS shall be employed in test conducted between the shells of adjacent contacts when tested in a connector housing.

3.5.3 Contact Resistance. When tested as specified in Paragraph 4.6.4, the contact resistance of mated inner contacts shall not exceed 9 milliohms. Shell contacts shall not exceed the following values.

<u>Plating</u>	<u>Milliohms</u>
Gold	3
Tin	5

3.5.4 Capacitance. Contacts tested as specified in Paragraph 4.6.5, shall not exceed 10 picofarads.

3.5.5 Voltage Standing Wave Ratio. Contact assemblies terminating RG-174 coaxial cable shall not exhibit VSWR exceeding 1.35 to 1.0 up to 500 MHz. Testing shall be conducted as specified in Paragraph 4.6.6.

3.5.6 Cable Retention. When tested as specified in Paragraph 4.6.7, minimum cable retention shall be as specified in Table II.

TABLE II

<u>Cable Type</u>	<u>Minimum Retention</u>
RG-174	25 pounds
RG-196	13 pounds

SHEET			AMP INCORPORATED	
			Harrisburg, Pa	
3 OF 11	LOC	A	NO.	108-12011
NAME		SUBMINIATURE COAXICON CONTACTS		
			REV	B

- 3.5.7 Contact Engaging and Separating Force. The total force required to engage or separate a contact assembly shall not exceed 1.5 pounds when tested in accordance with Paragraph 4.6.8.
- 3.5.8 Contact Durability. After the specified number of insertion and withdrawal cycles, as described in Paragraph 4.6.9, contact assemblies shall meet the requirements for Contact Resistance, Paragraph 3.5.3.
- 3.5.9 Thermal Shock. Contact assemblies, subjected to temperature extremes of -65° to $+105^{\circ}$ C, shall show no evidence of physical damage upon completion of the test specified in Paragraph 4.6.10.
- 3.5.10 Humidity. Contact assemblies shall be exposed to a relative humidity of 90 - 95% for a period of 96 hours when tested in accordance with Paragraph 4.6.11. Following the exposure, the contacts shall meet the requirements for Insulation Resistance and Dielectric Withstanding Voltage.
- 3.5.11 Vibration. Contact assemblies shall be subjected to high frequency vibration of 10 - 2000 Hz as specified in Paragraph 4.6.12. Throughout the test, electrical continuity shall be monitored with no evidence of interruption exceeding 1 microsecond.
- 3.5.12 Physical Shock. Contact assemblies shall be subjected to 75 G's of physical shock as specified in Paragraph 4.6.13. Throughout the test, electrical continuity shall be monitored with no evidence of interruption exceeding 1 microsecond.
- 3.5.13 Altitude. When tested at a simulated altitude of 70,000 feet in accordance with Paragraph 4.6.14, contacts shall withstand a test potential of 150 VRMS between the inner contact and outer shell and 150 VRMS between the outer shells of adjacent contacts.
- 3.5.14 Contact Retention. When tested as specified in Paragraph 4.6.15, an axial force of 15 pounds shall not dislodge the contacts from the connector housing after 10 insertions and extractions.
- 3.5.15 Heat Soak. After 8 hours exposure to a temperature of 125° C as specified in Paragraph 4.6.16, contacts shall be mated, meet the dielectric withstanding voltage requirements of Paragraph 3.5.2, be unmated and visually examined for evidence of any movement of parts or physical damage.

SHEET	AMP INCORPORATED Harrisburg, Pa		
4 OF 11	LOC	A	NO. 108-12011
NAME SUBMINIATURE COAXICON CONTACTS			

NUMBER
108-12011

4.0 QUALITY ASSURANCE PROVISIONS

4.1 General Provisions. The quality provisions specified herein shall be employed in the manufacturing and testing of this product to assure normal production units meet the performance requirements of this specification.

4.2 Classification of Test.

- (A) Qualification Inspection (See 4.4)
- (B) Quality Conformance Inspection (See 4.5)

4.3 Test Conditions.

4.3.1 Measurements. Measurements shall be taken with instruments that have been calibrated in accordance with specification MIL-C-45662.

4.3.2 Laboratory Conditions. Unless otherwise specified, normal laboratory temperature, humidity and atmospheric pressure shall be considered acceptable for test purposes.

4.3.3 Coaxial Cable. Coaxial cable employed for test shall be in accordance with MIL-C-17.

4.4 Qualification Inspection.

4.4.1 Sample Selection. Contacts selected for test purpose shall be representative of current production. Preparation of test samples shall be conducted in accordance with AMP Instruction Sheets governing assembly and crimping technique.

4.4.2 Test Procedure. Qualification Inspection shall be conducted in accordance with Table III in the sequence specified. Test Groups I through III shall consist of 20 contact assemblies and Group IV shall consist of 10 contact assemblies.

SHEET 5 OF 11	 AMP INCORPORATED Harrisburg, Pa.		
	LOC A	NO 108-12011	REV B
NAME SUBMINIATURE COAXICON CONTACTS			

TABLE III

Qualification Inspection Sequence				
Test or Examination	Test Group and Sequence			
	I	II	III	IV
Examination of Product	1	1	1	1
Insulation Resistance	3-8		2-7	
Dielectric Withstanding Voltage	4-9		3-8	
Contact Resistance	2-10	2-5	4-9	
Capacitance				2
Voltage Standing Wave Ratio				3
Cable Retention		8		
Contact Retention		7		
Contact Engaging and Separating Force		3-6		
Contact Durability		4		
Thermal Shock			5	
Humidity			6	
Vibration	5			
Physical Shock	6			
Altitude	7			
Heat Soak			10**	

** Performed only on contacts when crimped to cable having polytetrafluoroethylene dielectric.

4.5 Quality Conformance Inspection.

- 4.5.1 Sample Selection. Unless otherwise specified, sampling procedures shall be in accordance with MIL-STD-105. Sampling and Acceptable Quality Levels shall be as specified in the applicable AMP Quality Specification. Dimensional requirements shall be in accordance with the applicable AMP Product Drawing.
- 4.5.2 Test Procedure. Contacts supplied in accordance with this specification shall meet the requirements for Quality Conformance Inspection, Table IV. Examination and test shall be conducted in the order specified.



SHEET 6 OF 11	 AMP INCORPORATED Harrisburg, Pa.		REV B
	LOC A	NO. 108-12011	
NAME SUBMINIATURE COAXICON CONTACTS			

TABLE IV

Quality Conformance Inspection	
Test or Examination	Test Method
Examination of Product	Quality Specification
Engaging and Separating Force	Paragraph 4.6.8
Contact Resistance	Paragraph 4.6.4
Dielectric Withstanding Voltage	Paragraph 4.6.3

4.6 Test Methods.

- 4.6.1 Examination of Product. Test samples shall be thoroughly examined to assure proper assembly in accordance with the manufacturer's instructions. They shall show no evidence of physical defects or being otherwise unfit for testing.
- 4.6.2 Insulation Resistance. Measurements shall be conducted in accordance with Test Condition A, Method 302 of MIL-STD-202. Measurements shall be taken between both the inner contact and outer shells of individual contacts and between the outer shells of adjacent contacts. The minimum values recorded shall not be less than specified in Paragraph 3.5.1.
- 4.6.3 Dielectric Withstanding Voltage. Test shall be conducted in accordance with Method 301 of MIL-STD-202 using the test voltages specified in Paragraph 3.5.2. Separate test shall be conducted by applying the applicable 60 Hz test voltage between the inner contact and outer shell of the contacts and then between the adjacent shells of the contacts in the connector housing.
- 4.6.4 Contact Resistance. Mated contacts shall be subjected to a voltage drop measurement taken between mated inner contacts and between mated shells. The voltage drop across the inner contacts shall be measured through the crimp port of the pin to the crimp port of the socket. Voltage drop of the mated shells shall be measured between the ridges located at the wire-entry end of the shell. (See Figure I.) All measurements shall be conducted using a direct current of 1.0 ampere.

SHEET	 AMP INCORPORATED <i>Harrisburg, Pa.</i>				
				7 OF 11	
LOC	A	NO.	108-12011	REV	B
NAME SUBMINIATURE COAXICON CONTACTS					

- 4.6.5 Capacitance. The capacitance of a contact shall be determined in accordance with Method 305 of MIL-STD-202. A test frequency of 1 MHz shall be employed for test. Precaution shall be taken to compensate for stray capacitance such as coaxial cable, terminal connections, etc. Contacts tested shall meet the requirements specified in Paragraph 3.5.4.
- 4.6.6 Voltage Standing Wave Ratio. Tests shall be conducted at 100, 200, 300, 400, and 500 MHz, following the procedure described herein. Test circuit is illustrated in Figure II.
- 4.6.6.1 Cable Standardization. A long length of cable shall be assembled to the adapter. The length is adequate if shorting the far end of the cable does not shift the minimum of the standing wave at the lowest test frequency specified. The contact assembly to be tested is not included on the initial calibration.
- 4.6.6.2 Tuner Adjustment. For each frequency at which the VSWR is to be measured, set and lock a double stub tuner or record the setting of an adjustable tuner so that the VSWR recorded on the standing wave indicator is 1.01 to 1 or less.
- 4.6.6.3 Contact Pair Insertion. Cut the cable and insert a contact assembly a short distance from the adapter so that the insertion loss of the cable between the adapter and contact assembly is negligible.
- 4.6.6.4 VSWR Measurement. At each test frequency, insert the proper pretuned tuner for that frequency. The VSWR reading now obtained on the standing wave indicator is the cable to cable VSWR of the contact assembly.
- 4.6.7 Cable Retention. The pin or socket shall be held firmly between the jaws of a tensile machine in a manner which will allow the outer shell and inner contact to be pulled simultaneously. The braid and center conductor of the cable shall be joined together to create an equal pull throughout. All testing shall be performed with a head speed of 1 inch per minute.

SHEET	 AMP INCORPORATED Harrisburg, Pa		REV
8 OF 11	LOC	A	108-12011
NAME			
SUBMINIATURE COAXICON CONTACTS			

- 4.6.8 Contact Engaging and Separating Force. Contact assemblies shall be firmly held in a self-aligning fixture. The pin and socket contacts shall be mated and unmated while recording the maximum force developed. Care shall be taken to assure proper alignment is maintained throughout the test.
- 4.6.9 Contact Durability. Contact assemblies inserted into appropriate connector housings shall be mated and unmated the following number of cycles at a rate not exceeding 10 cycles per minute.

<u>Shell Plating</u>	<u>No. of Cycles</u>
Gold	500
Tin	250

Upon completion, contact pairs shall be removed from the connector housing and shall meet the requirements of Paragraph 3.5.8.

- 4.6.10 Thermal Shock. Contact assemblies housed in appropriate connectors shall be subjected to 5 thermal shock cycles in accordance with Test Condition B, Method 107 of MIL-STD-202. During the last test cycle at both temperature extremes, a test for mating and unmating shall be conducted. After test, the contacts shall meet the requirements specified in Paragraph 3.5.9.
- 4.6.11 Humidity. Contact assemblies housed in appropriate connectors shall be subjected to humidity in accordance with Method 103 of MIL-STD-202. Upon completion of the 96 hours exposure, the connectors shall be unmated and permitted to dry at room temperature for 4 hours.
- 4.6.12 Vibration. Contact assemblies housed in appropriate connectors shall be subjected to vibration in accordance with Test Condition D, Method 204 of MIL-STD-202. Throughout the test, electrical continuity of the inner contacts and outer shells shall be monitored to detect electrical discontinuities exceeding 1 microsecond.
- 4.6.13 Physical Shock. Contact assemblies housed in appropriate connectors shall be subjected to physical shock in accordance with Test Condition H, Method 213 of MIL-STD-202. The contacts shall experience 4 shock pulses in each of their 3 major axes. Throughout the test, electrical continuity of the inner contacts and outer shells shall be monitored to detect electrical discontinuities exceeding 1 microsecond.

SHEET	 AMP INCORPORATED Harrisburg, Pa.		
	A	108-12011	B
NAME			
SUBMINIATURE COAXICON CONTACTS			

- 4.6.14 Altitude. Mated connectors shall be subjected to a simulated altitude of 70,000 feet (33.95 MmHg) for a period of 1 hour in accordance with Test Condition C, Method 105 of MIL-STD-202. After the 1-hour exposure and while at reduced pressure, the 60-Hz test voltages of the magnitude specified in Paragraph 3.5.13 shall be applied for a period of 1 minute. Precaution shall be taken to eliminate arcing or corona external to the connector while conducting the test.
- 4.6.15 Contact Retention. Contacts in unmated connectors, shall be subjected to 9 insertions and extractions utilizing the applicable insertion/extraction tool. After completing the tenth insertion, each contact shall withstand the axial load specified in Paragraph 3.5.14 in the normal removal direction. The axial load shall be applied at a uniform rate not exceeding 1 pound per second and shall be held at the specified level for a period of 1 minute.
- 4.6.16 Heat Soak. Unmated contacts shall be placed in an air circulating oven at a temperature of 125°C for a period of 8 hours. At the end of this time, contacts shall meet the performance requirements of Paragraph 3.5.15.

FIGURE I
CONTACT RESISTANCE

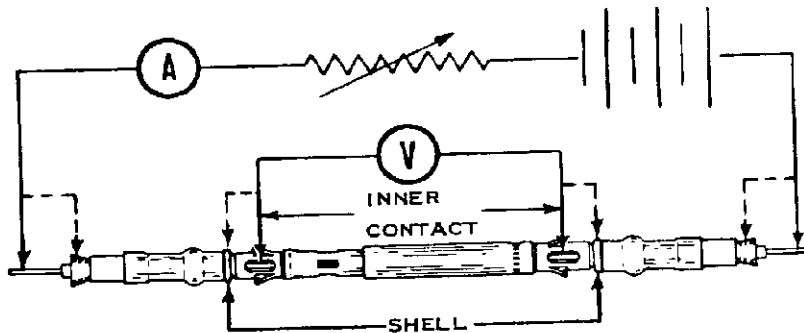

SHEET 10 OF 11	AMP INCORPORATED Harrisburg, Pa.	LOC A	NO. 108-12011	REV B
NAME SUBMINIATURE COAXICON CONTACTS				

FIGURE II

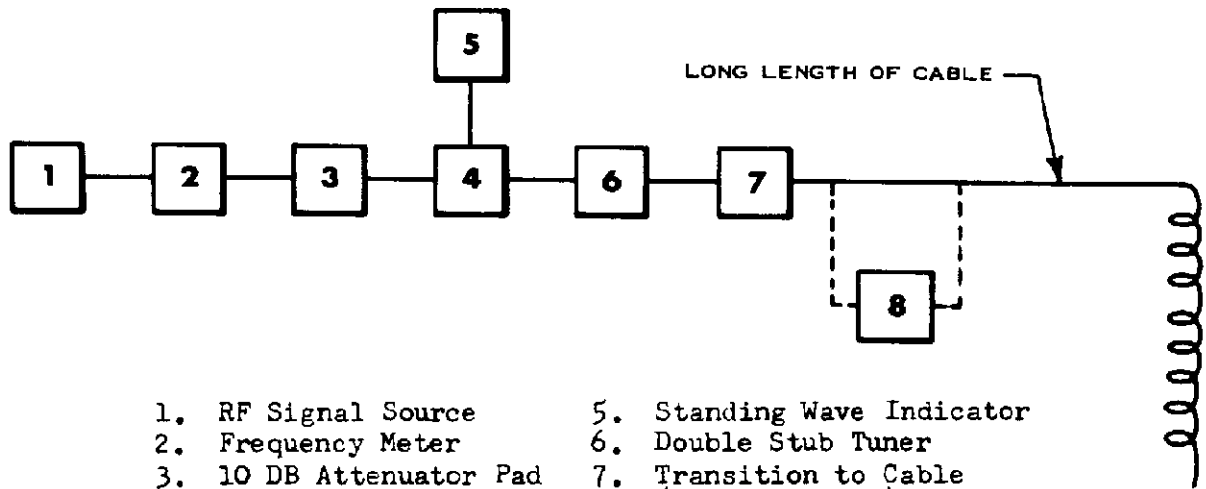

- | | |
|-------------------------|---|
| 1. RF Signal Source | 5. Standing Wave Indicator |
| 2. Frequency Meter | 6. Double Stub Tuner |
| 3. 10 DB Attenuator Pad | 7. Transition to Cable
(When Required) |
| 4. Slotted Section | 8. Contact Assembly
Under Test |

SHEET <u>110F11</u>			AMP INCORPORATED Harrisburg, Pa	
	LOC A	NO. 108-12011	REV B	
NAME SUBMINIATURE COAXICON CONTACTS				